

**3 Series MDO
Mixed Domain Oscilloscope
Printable Help**



3 Series MDO Mixed Domain Oscilloscope Printable Help

Warning

The servicing instructions are for use by qualified personnel only. To avoid personal injury, do not perform any servicing unless you are qualified to do so. Refer to all safety summaries prior to performing service.

Supports Product Firmware V1.0 and above

www.tek.com

077-1497-01

Copyright © Tektronix. All rights reserved. Licensed software products are owned by Tektronix or its subsidiaries or suppliers, and are protected by national copyright laws and international treaty provisions. Tektronix products are covered by U.S. and foreign patents, issued and pending. Information in this publication supersedes that in all previously published material. Specifications and price change privileges reserved.

TEKTRONIX and TEK are registered trademarks of Tektronix, Inc.

This product contains open source software. License information is available at (your instrument IP address)/opensource. To find your instrument IP address tap **Utility > I/O**. For programs licensed under the "GNU General Public License (GPL) or Lesser GNU General Public License (LGPL)" the complete corresponding sources are available. You can order a CD containing the sources from us for a period of three years after download of the software, by sending a written request to:

Chief Intellectual Property Counsel, Tektronix, Inc.

MS 50/LAW

14150 SW Karl Braun Dr.

Beaverton OR, 97077

This offer is valid to anyone in receipt of this information.

Your request should include: (i) the name of the product, (ii) your (company) name, and (iii) your return mailing and email address (if available).

Please note that we may charge you a fee to cover the cost of performing this distribution.

Contacting Tektronix

Tektronix, Inc.

14150 SW Karl Braun Drive

P.O. Box 500

Beaverton, OR 97077

USA

For product information, sales, service, and technical support:

- In North America, call 1-800-833-9200.
- Worldwide, visit www.tek.com to find contacts in your area.

Table of Contents

TEKTRONIX END USER LICENSE AGREEMENT	11
Open Source GPL License Notice	17
GPU disclosure	19
Welcome to the 3 Series MDO instrument help	xxi

Product documents and support

Related documents	1
Product support and feedback	2

Accessories

Standard accessories	3
Recommended accessories	3
Recommended probes	4

Factory options

Bandwidth options	7
Digital channels option	7
Spectrum analyzer frequency range options	8
Arbitrary Function Generator (AFG) option	8
Enhanced instrument security	9
Serial bus decode and trigger options	9
Power Analysis option	10
Application bundle	10
Power cord options	10
Service options	11

Option upgrades

Post-purchase instrument options	13
Bandwidth upgrade options	14
How to install an option license	15

Install your instrument

Check shipped accessories	17
Safely rotate the handle	18

Operating requirements	19
Input signal requirements	20
Powering the oscilloscope	21
Check that the oscilloscope passes power-on self tests	22
Secure (lock) the oscilloscope	22
Connecting probes	23
Rackmount information	24

Getting acquainted with your instrument

Front panel controls and connectors	25
Rear panel connections	35
The user interface screen	36
Identifying items in the time domain display	37
Identifying items in the frequency domain display	41
Identifying items in the arbitrary function generator display	43
Identifying items in the digital voltmeter display	43
Badges	44
Configuration menus	50
Zoom user interface elements	51
Using the touchscreen interface for common tasks	53
Accessing application help	54

Configure the instrument

Set the date and time	55
Functional check	56
Download and install the latest firmware	56
Run Signal Path Compensation (SPC)	57
Compensate TPP0250, TPP0500B, or TPP1000 probes	58
Compensate passive probes	60
Connect to a network (LAN)	61
Mount a network drive	61
Unmount a network drive	62
Deskew analog input channels - quick visual method	63
Deskew analog input channels - measurement method	64
Connect a keyboard or mouse	65
Connect an external monitor or projector	65
ESD prevention guidelines	65

Analog channel operating basics

Acquiring a signal	67
Quickly display a waveform (autoset)	68
Set horizontal parameters	69
How to trigger on a signal	69
Set the acquisition mode	71
Start and stop an acquisition	72
Add a channel waveform to the display	73
Configure channel or waveform settings	74
Add a math, reference, or bus waveform	75
Add a measurement	77
Configure a measurement	79
Delete a measurement or search badge	81
Display an XY waveform	81
Display an FFT math waveform	82
Add a search	82
Change waveform view settings	84
Display and configure cursors	85
Using Default Setup	86
Using Fast Acq	86
Remote access from a Web browser	88
Connect the oscilloscope to a PC using a USB cable	88

Acquiring digital signals

Acquiring digital signals	89
Connect and set up digital signals	89
Add a serial bus to the Waveform view	92
Add a parallel bus to the Waveform view	94

Advanced triggering

Advanced triggering	97
Triggering concepts	97
Trigger on a pulse width event	98
Set Trigger Holdoff	99
Trigger on sequential events (A and B triggers)	100
Set up trigger on a parallel bus	101
Set up trigger on a serial bus	101

Trigger using the AUX input	101
-----------------------------------	-----

Setting waveform display parameters

Setting waveform display parameters	103
Set the waveform persistence style and intensity	103
Set the graticule style and intensity	104

Zooming on waveforms

Zooming on waveforms	105
Turn on Zoom mode	105
Zoom mode and Searches	106

Customizing measurements

Customizing measurements	107
Set measurement reference levels	107
Set measurement gates	108

Saving and recalling information

Save a screen image	110
Save a waveform to a file	111
Save instrument settings to a file	112
Save all	112
Recall a Reference waveform	113
Recall a Setup file	114

Menus and dialog boxes

The Acquisition configuration menu	115
Add Measurements configuration menu overview	117
Amplitude Measurements panel	118
Time Measurements panel	120
Other Measurements panel	122
The Power Measurements panel (optional)	123
Measurement configuration menu	129
Measurement Name panel (Measurement configuration menu)	130
Global Measurement Settings panel (Measurement configuration menu)	131

Power measurement configuration menu overview (optional)	133
Power Measurement Name panel (Measurement configuration menu)	134
SOA Mask definition controls and fields	134
Reference Levels panel (Power measurement configuration Menu)	135
Bus configuration menu	135
ARINC429 serial bus menu	136
Audio serial bus configuration menu	138
CAN serial bus configuration menu	140
FlexRay serial bus configuration menu	143
I2C serial bus configuration menu	144
LIN serial bus configuration menu	146
MIL-STD-1553 serial bus menu	147
Parallel Bus configuration menu	149
Parallel Bus - Define Inputs menu	150
RS-232 serial bus menu	151
SPI serial bus configuration menu	153
USB serial bus configuration menu	155
Add Results Table	158
Search configuration menu overview	159
Bus Search configuration menus	159
ARINC429 serial bus search configuration menu	160
Audio serial bus search configuration menu	162
CAN serial bus search configuration menu	163
FlexRay serial bus search configuration menu	165
I2C serial bus search configuration menu	167
LIN serial bus search configuration menu	168
MIL-STD-1553 Search configuration menu	169
Parallel bus search configuration menu	171
RS-232 serial bus search configuration menu	172
SPI serial bus search configuration menu	173
USB serial bus search configuration menu	173
Edge Search configuration menu	175
Logic Search configuration menu	177
Logic Search - Define Inputs configuration menu	179
Pulse Width Search configuration menu	180
Rise/Fall Time Search configuration menu	182
Runt Search configuration menu	184
Setup and Hold Search configuration menu	185
Setup and Hold Search - Define Inputs configuration menu	187

Timeout Search configuration menu	187
Analog Channel configuration menu	189
Probe Setup panel (Channel configuration menu)	190
Probe Compensation configuration menu (analog channels Probe Setup panel)	191
Other panel (Channel configuration menu)	191
Deskew configuration menu (Other panel Channel configuration menu)	192
AFG configuration menu	194
Save As configuration menu (AFG menu)	197
RF configuration menu	198
Traces panel (RF configuration menu)	199
Horizontal badge configuration menu	200
Spectral math configuration menu	201
Spectral Ref configuration menu	201
Cursor configuration menu	202
Date and Time configuration menu	203
Digital channel configuration menu	203
DVM configuration menu	204
Menu bar overview	205
Recall configuration menu (File menu)	206
Save As configuration menu (File menu)	207
Print configuration menu	211
Add Printer configuration menu	212
File Utilities configuration (File menu)	212
Mount Network Drive configuration menu	214
User Preferences (Utility menu)	215
I/O (Utility menu)	217
LAN Reset configuration menu (Utility > I O menu)	220
Self Test configuration menu (Utility menu)	221
Calibration configuration menu (Utility menu)	222
Security configuration menu (Utility menu)	223
Enter Password configuration menu (optional)	225
Set Password configuration menu (optional)	225
Demo (Utility menu)	226
Help (Help menu)	227
About (Help menu)	227
Horizontal configuration menu	228
Math configuration menu overview	229
Math configuration menu	229
Equation Editor (Math configuration menu)	231

Add Functions (math Equation Editor)	232
Pick Measurement	233
Reference waveform configuration menu	234
Recall configuration menu (Ref waveform configuration menu)	235
Search configuration menu	236
Trigger configuration menu overview	236
Bus Trigger configuration	237
ARINC429 serial bus trigger settings panel	238
Audio serial bus trigger settings panel	240
CAN serial bus trigger settings panel	241
FlexRay serial bus trigger settings panel	242
I2C serial bus trigger settings panel	245
LIN serial bus trigger settings panel	247
MIL-STD-1553 serial bus trigger settings panel	248
Parallel serial bus trigger settings panel	250
RS-232 serial bus trigger settings panel	251
SPI serial bus trigger settings panel	252
USB serial bus trigger settings panel	253
Edge Trigger configuration menu	255
Logic Trigger configuration menu	257
Logic Trigger - Define Inputs configuration menu	259
Pulse Width Trigger configuration menu	260
Rise Fall Time Trigger configuration menu	261
Runt Trigger configuration menu	263
Sequence Trigger configuration menu	264
Setup & Hold Trigger configuration menu	266
Setup & Hold Trigger - Define Inputs configuration menu	268
Timeout Trigger configuration menu	268
Video trigger configuration menu	270
Mode and Holdoff panel	271
Act On Trigger configuration menu	273
Viewing the trigger frequency	273
Virtual Keyboard	274
Binary, decimal, hex, and octal virtual keypads	274
Numeric input keypad	275
IP address keypad	275
Waveform View configuration menu	276
Cursors menu (RF view)	278
RF badge menu	278

Waveform acquisition concepts

Acquisition concepts	281
Acquisition hardware	281
Sampling process	281
Waveform record	282
Acquisition modes	283
How the acquisition modes work	283
Coupling	285
Scaling and positioning	285
Vertical acquisition considerations	286
Horizontal acquisition considerations	287
Using reference waveforms and traces	288
Frequency-Domain concepts	289
Displaying the Frequency Domain menu	289
RF waveform view and badges	289
Spectrum trace handle	290
Spectrum trace markers	291
The RF waveform view user interface	291
Using spectral analysis controls	292
Setting up the RF input	293
Resolution bandwidth	294
Spectrogram display	295
Automatic peak markers	296
Frequency domain cursors	297
Use the Arbitrary Function Generator	298

Triggering concepts

Trigger sources	303
Trigger types	304
Trigger modes	305
Trigger holdoff	305
Trigger coupling	306
Trigger slope and level	306
Trigger position in waveform record	307
Trigger delay	307
Bus triggering concepts	308
Pulse width trigger concepts	309

Timeout trigger	309
Runt trigger	309
Logic trigger concepts	309
Setup and Hold trigger concepts	310
Rise/Fall time trigger concepts	311
Sequential (A B) trigger concepts	311

Waveform display concepts

Waveform display overview	313
Waveform preview mode	314
Horizontal position and the horizontal reference point	314
Annotating the screen	314

Measurement concepts

Taking automatic measurements in the time domain	315
Taking automatic measurements in the frequency domain	316
Taking digital voltmeter measurements	316
Taking manual measurements with cursors	317
Making automated power measurements	319
Using cursor readouts	319
Using XY Cursors	320
Measurement variables	321
Missing or out-of-range samples	323
Math waveforms	324
Math waveform elements	324
Guidelines for working with math waveforms	325
Math waveform editor syntax	325
Math waveform differentiation	326
Math waveform offset position and scale	327
Waveform integration	327
Using math waveforms	328
Using advanced math	329
Using FFT	330
FFT process	331
FFT and aliasing	332
Blackman-Harris FFT window concepts	333
Hanning FFT window	333
Hamming window	334

Table of Contents

Rectangular window	334
Using spectrum math	335

References

Upgrading firmware	337
Cleaning	337

TEKTRONIX END USER LICENSE AGREEMENT

This End User Agreement (“Agreement”) is an agreement between Tektronix, Inc., an Oregon corporation, and its corporate affiliates, subsidiaries, and divisions as applicable (collectively, “Tektronix,” “we,” “us,” or “our”) and You (including any entity or organization you represent, collectively, “Customer” or “You”). Please read this Agreement carefully as this Agreement governs the terms and conditions under which You are permitted to use Tektronix’s software and services.

THE SOFTWARE, ENCODED OR INCORPORATED WITHIN EQUIPMENT OR ACCOMPANYING THIS AGREEMENT, IS FURNISHED SUBJECT TO THE TERMS AND CONDITIONS OF THIS AGREEMENT. BY INDICATING YOUR ACCEPTANCE OF THESE TERMS BY SELECTING AN "ACCEPT" OR SIMILAR BUTTON IN A SOFTWARE MENU, OR BY RETAINING THE SOFTWARE FOR MORE THAN THIRTY DAYS OR USING THE SOFTWARE IN ANY MANNER YOU (A) ACCEPT THIS AGREEMENT AND AGREE THAT YOU ARE LEGALLY BOUND BY ITS TERMS; AND (B) REPRESENT AND WARRANT THAT: (I) YOU ARE OF LEGAL AGE TO ENTER INTO A BINDING AGREEMENT; AND (II) IF YOU ARE A REPRESENTATIVE FOR A CORPORATION OR OTHER LEGAL ENTITY, YOU HAVE THE RIGHT, POWER, AND AUTHORITY TO ENTER INTO THIS AGREEMENT ON BEHALF OF SUCH ENTITY AND BIND SUCH ENTITY TO ITS TERMS. IF YOU DO NOT AGREE TO THE TERMS OF THIS AGREEMENT, TEKTRONIX WILL NOT AND DOES NOT LICENSE THE SOFTWARE TO YOU AND YOU MUST NOT DOWNLOAD, INSTALL, OR USE THE SOFTWARE. UNITED STATES GOVERNMENT CUSTOMERS OR END-USERS MAY REQUEST A GOVERNMENT ADDENDUM TO THIS AGREEMENT.

NOTWITHSTANDING ANYTHING TO THE CONTRARY IN THIS AGREEMENT OR YOUR ACCEPTANCE OF THE TERMS AND CONDITIONS OF THIS AGREEMENT, NO LICENSE IS GRANTED (WHETHER EXPRESSLY, BY IMPLICATION, OR OTHERWISE) UNDER THIS AGREEMENT TO ANY SOFTWARE THAT YOU DID NOT ACQUIRE LAWFULLY OR THAT IS NOT A LEGITIMATE, AUTHORIZED COPY OF TEKTRONIX’S SOFTWARE. THIS AGREEMENT EXPRESSLY EXCLUDES ANY RIGHTS CONCERNING SUCH ILLEGITIMATE COPIES.

IF THESE TERMS ARE NOT ACCEPTABLE, THE UNUSED SOFTWARE AND ANY ACCOMPANYING DOCUMENTATION SHOULD BE RETURNED PROMPTLY TO TEKTRONIX (WITHIN 30 DAYS OF PURCHASE) FOR A FULL REFUND OF THE LICENSE FEE PAID. (FOR INFORMATION REGARDING THE RETURN OF SOFTWARE ENCODED OR INCORPORATED WITHIN EQUIPMENT, CONTACT THE NEAREST TEKTRONIX SALES OFFICE.)

DEFINITIONS.

“Equipment” means Tektronix equipment that the Software is encoded or incorporated within or installed onto.

LICENSE.

Subject to the terms and conditions of this Agreement, Tektronix grants You a non-exclusive, non-transferable license to the Software, as follows.

You may:

1. Use the Software with the Equipment, or if the Software is not encoded or incorporated in any Tektronix equipment, on no more than one machine at a time; and
2. Copy the Software for archival or backup purposes, provided that no more than one (1) such copy is permitted to exist at any one time, and provided that each copy includes a reproduction of any patent or copyright notice or restrictive rights legend that was included with the Software, as received from Tektronix;
3. Fully transfer the Equipment to a third party but only if prominently accompanied by this End User License Agreement, and such third-party recipients agree to be bound by the terms of this Agreement; and
4. Integrate Tektronix products that contain the Software into a system and sell or distribute that system to third parties, provided that those third parties are bound by the terms of this Agreement, and provided that You (i) do not separate the Software from any Equipment it is incorporated into, (ii) do not retain any copies of the Software, and (iii) do not modify the Software.

You may not:

1. Use the Software other than for its intended purpose as provided above in the section “You may,” or in conflict with the terms and restrictions of this Agreement;
2. Distribute or transfer the Software to any person or organization outside of Your organization without Tektronix’s prior written consent, except in connection with a permitted use authorized in “You may” paragraphs 3 or 4 above;
3. Decompile, decrypt, disassemble, or otherwise attempt to derive the source code, techniques, processes, algorithms, know-how, or other information (collectively “Reverse Engineer”) from the Software or permit or induce any third party to do so, except to the limited extent allowed by directly applicable law or third party license (if any), and only to obtain information necessary to achieve interoperability of independently created software with the Software;
4. Modify, translate, adapt, or create derivative works of the Software, or merge the Software with any other software;
5. Copy the documentation accompanying the Software;
6. Remove any copyright, trademark, or other proprietary notices from the Software or any media relating thereto; or
7. Export or re-export, directly or indirectly, the Software or Equipment, any associated documentation, or systems created in accordance with “You may” section 4 above, to any country to which such export or re-export is restricted by law or regulation of the United States or any foreign government having jurisdiction without the prior authorization, if required, of the Office of

Export Administration, Department of Commerce, Washington, D.C. and the corresponding agency of such foreign government;

8. Use the Software or Equipment in any manner or for any purpose that infringes, misappropriates, or otherwise violates any intellectual property rights or other proprietary rights of any person, or any applicable laws;
9. Use the Software or Equipment in a network or system with other products or services that are incompatible, insecure or not compliant with applicable laws;
10. Bypass, circumvent, damage or otherwise interfere with any security or other features of the Software or Equipment designed to control the manner in which they are used, or harvest or mine Tektronix's proprietary content or information from the Software or Equipment.

THE SOFTWARE MAY NOT BE USED, COPIED, MODIFIED, MERGED, OR TRANSFERRED TO ANOTHER EXCEPT AS EXPRESSLY PERMITTED BY THESE TERMS AND CONDITIONS.

FEEDBACK

If You provide feedback to Tektronix concerning the functionality and performance of the Software or Equipment, including without limitation identifying potential errors and improvements, any comments, questions, suggestions, or the like ("Feedback"), Tektronix is free to use such Feedback without any attribution, compensation, or restriction in any manner to improve or enhance its products, irrespective of any other obligation or limitation between the Parties governing such Feedback. You hereby grant Tektronix an irrevocable, worldwide, perpetual, royalty-free license to use Your Feedback for any purpose whatsoever and waive any moral rights You may have in the Feedback. Tektronix is not obligated to use Your Feedback.

OWNERSHIP

Title to the Software and all copies thereof, but not the media on which the Software or copies may reside, shall remain with Tektronix or others from whom Tektronix has obtained a respective licensing right.

GOVERNMENT NOTICE

If the Software or any related documentation is acquired by or for an agency of the U.S. Government, the Software and documentation shall be considered "commercial computer software" or "commercial computer software documentation" respectively, as those terms are used in 48 CFR §12.212, 48 CFR §227.7202, or 48 CFR §252.227-7014, and are licensed with only those rights as are granted to all other licensees as set forth in this Agreement.

TERM

The license granted herein is effective until terminated. The license may be terminated by You at any time upon written notice to Tektronix. The license may be terminated by Tektronix if You fail to comply with any term or condition and such failure is not remedied within fifteen (15) days after notice hereof from Tektronix. Upon termination by either party, You shall return to Tektronix or destroy, the Software and all associated documentation, together with all copies in any form.

IF YOU TRANSFER, DISTRIBUTE, OR OTHERWISE MAKE AVAILABLE ANY COPY, MODIFICATION, OR MERGED PORTION OF THE SOFTWARE WITHOUT THE AS EXPRESS PERMISSION OF THESE TERMS AND CONDITIONS OR PRIOR WRITTEN CONSENT OF TEKTRONIX, YOUR LICENSE WILL BE IMMEDIATELY AND AUTOMATICALLY TERMINATED.

LIMITED WARRANTY.

Tektronix does not warrant that the functions contained in the Software will meet Your requirements or that the operation of the Software will be uninterrupted, secure, or error-free.

EXCEPT AS SEPARATELY PROVIDED IN A WRITTEN WARRANTY FROM TEKTRONIX, THE SOFTWARE IS PROVIDED "AS IS" WITHOUT ANY WARRANTY OF ANY KIND, EXPRESS OR IMPLIED, INCLUDING BUT NOT LIMITED TO, THE WARRANTIES OF MERCHANTABILITY, FITNESS FOR A PARTICULAR PURPOSE, TITLE, QUIET ENJOYMENT, AND NON-INFRINGEMENT.

THE SOFTWARE IS NOT DESIGNED OR INTENDED FOR USE IN HAZARDOUS ENVIRONMENTS REQUIRING FAIL-SAFE PERFORMANCE INCLUDING WITHOUT LIMITATION, IN THE OPERATION OF NUCLEAR FACILITIES, AIRCRAFT NAVIGATION OR COMMUNICATION SYSTEMS, AIR TRAFFIC CONTROL, WEAPONS SYSTEMS, DIRECT LIFE-SUPPORT MACHINES, OR ANY OTHER APPLICATION IN WHICH THE FAILURE OF THE SOFTWARE COULD LEAD TO DEATH, PERSONAL INJURY OR SEVERE PHYSICAL OR PROPERTY DAMAGE (COLLECTIVELY "HAZARDOUS ACTIVITIES"). TEKTRONIX AND ITS AFFILIATES, LICENSORS, AND RESELLERS EXPRESSLY DISCLAIM ANY EXPRESS OR IMPLIED WARRANTY OF FITNESS FOR HAZARDOUS ACTIVITIES.

LIMITATION OF LIABILITY

IN NO EVENT SHALL TEKTRONIX, ITS AFFILIATES, LICENSORS, OR RESELLERS BE LIABLE FOR: (1) ECONOMICAL, INCIDENTAL, CONSEQUENTIAL, INDIRECT, SPECIAL, PUNITIVE OR EXEMPLARY DAMAGES, WHETHER CLAIMED UNDER CONTRACT, TORT OR ANY OTHER LEGAL THEORY, (2) LOSS OF OR DAMAGE TO YOUR DATA OR PROGRAMMING, LOSS OF PROFITS, BUSINESS INTERRUPTION, OR OTHER PECUNIARY LOSS ARISING FROM THE USE OF (OR INABILITY TO USE) THE SOFTWARE, (3) PENALTIES OR PENALTY CLAUSES OF ANY DESCRIPTION, (4) ANY DAMAGE, CLAIMS, OR LOSSES RESULTING FROM THE USE OF THE SOFTWARE IN CONJUNCTION WITH OTHER PRODUCTS OR SERVICES (INCLUDING THIRD-PARTY PRODUCTS OR SERVICES); OR (5) INDEMNIFICATION OF YOU OR OTHERS FOR COSTS, DAMAGES, OR EXPENSES RELATED TO THE GOODS OR SERVICES PROVIDED UNDER THIS LIMITED WARRANTY, EVEN IF TEKTRONIX OR ITS AFFILIATES, LICENSORS, OR RESELLERS HAVE ADVANCE NOTICE OF THE POSSIBILITY OF SUCH DAMAGES. BECAUSE SOME STATES/JURISDICTIONS DO NOT ALLOW THE EXCLUSION OR LIMITATION OF LIABILITY FOR CONSEQUENTIAL OR INCIDENTAL DAMAGES, SOME OF THE ABOVE LIMITATIONS MAY NOT APPLY TO YOU, BUT THEY SHALL APPLY TO THE MAXIMUM EXTENT PERMITTED BY LAW. NOTWITHSTANDING ANYTHING HEREIN TO THE CONTRARY, IN NO EVENT SHALL TEKTRONIX'S TOTAL AGGREGATED LIABILITY TO YOU FOR ALL DAMAGES IN ANY ONE OR MORE CAUSES OF ACTION EXCEED THE AMOUNT RECEIVED BY TEKTRONIX FROM YOU FOR THE SOFTWARE OR EQUIPMENT.

You are solely responsible for Your data. You must back up Your data before Tektronix or a third party performs any remedial, upgrade, or other work on Your systems, including any Equipment. If applicable law prohibits exclusion of liability for lost data, then Tektronix will only be liable for the cost of the typical effort to recover the lost data from Your last available back up.

SECURITY DISCLAIMER

This Software and its associated Equipment are not designed or intended to be used with unsecure networks. You acknowledge that use of the Equipment may rely upon certain networks, systems, and data communication mediums that are not controlled by Tektronix and that may be vulnerable to data or security breaches, including, without limitation, internet networks used by Your internet providers and the databases and servers controlled by Your internet providers. Tektronix shall not be liable for any such breaches, including without limitation, damages and/or loss of data related to any security breach, and disclaims all warranties, including any implied or express warranties that any content will be secure or not otherwise lost or altered.

For the avoidance of doubt, if You choose to connect this Software or Equipment to a network, it is Your sole responsibility to provide and continuously ensure a secure connection to that network. You agree to establish and maintain appropriate measures (e.g., firewalls, authentication measures, encryption, anti-virus applications, etc.) to protect the Software and Equipment and any associated data against security breaches including unauthorized access, destruction, use, modification, or disclosure.

Notwithstanding the foregoing, You shall not use any Products in a network with other products or services that are incompatible, insecure or not compliant with applicable laws.

THIRD-PARTY DISCLAIMER

The Software may contain software owned by third parties and obtained under a license from those parties (“Third Party Software”). Your use of such Third Party Software is subject to the terms and conditions of this Agreement and the applicable Third Party Software licenses. Except as expressly agreed otherwise, third parties do not warrant the Third Party Software, do not assume any liability with respect to its use, and do not undertake to furnish any support or information relating thereto.

GENERAL

Unless the Customer is the United States Government, this Agreement contains the entire agreement between the parties with respect to the use, reproduction, and transfer of the Software, and shall be governed by the laws of the state of Oregon.

You shall be responsible for any taxes that may now or hereafter be imposed, levied or assessed with respect to the possession or use of the Software or the rights and licenses granted under this Agreement, including any sales, use, property, value added, and excise taxes, and similar taxes, duties, or charges.

Any waiver by either party of any provision of this Agreement shall not constitute or be deemed a subsequent waiver of that or any other portion.

You may not assign this Agreement or any right or obligation under this Agreement, or delegate any performance, without Tektronix’s prior written consent. This section does not prohibit You from transferring the Equipment in accordance with Subsections 3 and 4 of the Section titled “You may” above.

All questions regarding this Agreement should be directed to the nearest Tektronix Sales Office.

Open Source GPL License Notice

For programs licensed under the "GNU General Public License (GPL) or Lesser GNU General Public License (LGPL)" the complete corresponding sources are available. You can order a CD containing the sources from us for a period of three years after download of the software, by sending a written request to:

Chief Intellectual Property Counsel, Tektronix, Inc.

MS 50/LAW

14150 SW Karl Braun Dr.

Beaverton OR, 97077

This offer is valid to anyone in receipt of this information.

Your request should include: (i) the name of the product, (ii) your (company) name, and (iii) your return mailing and email address (if available).

Please note that we may charge you a fee to cover the cost of performing this distribution.

GPU disclosure

This product utilizes a 3rd party device driver to enable the Graphics Processor Unit. The driver was obtained from NXP and requires the end user to accept an end-user licensing agreement.

This product uses Linux kernel version 3.0.35. If you wish to modify any of the GPL or LGPL components of the Linux kernel, and re-compile them, you will need to request a copy of the binary driver `imx-gpu-viv-5.0.11.p4.5.bin` from NXP. Instructions for compiling the kernel with the binary driver are below.

The GPU binary files rely on the `gpu-viv` driver package to be compiled into the kernel. This package can be found in the `"drivers/mxc/gpu-viv"` directory of this kernel distribution. To compile the package the user need only enable the following flags in the configuration file in the build configuration file named `"Config-tek_lk-3.0.35"`:

```
CONFIG_IMX_HAVE_PLATFORM_VIV_GPU=y
CONFIG_DRM_VIVANTE=y
CONFIG_HAS_DMA=y
CONFIG_MXC_GPU_VIV=m
```

An end user who wishes to utilize this binary package will need to ensure that the binary files are placed into a suitable directory in their `uImage` linux boot file. The command line used for installing the `galcore.ko` module which starts up the GPU driver on an `i.mx6` solo processor to perform 2D scaling is as follows:

```
" insmod /lib/modules/3.0.35/kernel/drivers/mxc/gpu-viv/galcore.ko" \
  " registerMemBase=0x00000000 registerMemSize=0x00004000 irqLine=-1" \
  " irqLine2D=42 registerMemBase3D=0x02200000
registerMemSize3D=0x00004000" \
  " irqLineVG=43 registerMemBase2D=0x02204000
registerMemSize2D=0x00004000" \
  " signal=48 baseAddress=0x80000000 fastClear=-1 " \
  " contiguousSize=0x006f50000 contiguousBase=0x9E000000 "
```

Finally, in the board support configuration file, memory needs to be reserved for the GPU. An example of how to configure the board can be found in the following file: `"/arch/arm/mach-mx6/ board-mx6q_sabresd.c"`. The salient lines are:

```
#include <mach/viv_gpu.h>
...
static struct viv_gpu_platform_data imx6q_gpu_pdata __initdata = {
    .reserved_mem_size = SZ_128M,
};
....
imx_add_viv_gpu(&imx6_gpu_data, &imx6q_gpu_pdata);
...
```

```
#if defined(CONFIG_MXC_GPU_VIV) ||
defined(CONFIG_MXC_GPU_VIV_MODULE)
if (imx6q_gpu_pdata.reserved_mem_size) {
    phys = memblock_alloc_base(imx6q_gpu_pdata.reserved_mem_size,
        SZ_4K, SZ_1G);
    memblock_remove(phys, imx6q_gpu_pdata.reserved_mem_size);
    imx6q_gpu_pdata.reserved_mem_base = phys;
}
#endif
```

Welcome to the 3 Series MDO instrument help

This help supports 3 Series MDO (MDO34, MDO32) instruments. See the following list for information on the key features.

MDO34, MDO32 Key features and benefits

MDO3 Series Mixed Domain Oscilloscopes are 6-in-1 integrated oscilloscopes, offering a built-in spectrum analyzer, arbitrary function generator, logic analyzer, protocol analyzer, digital voltmeter and frequency counter. Key features include:

- A dedicated RF input channel for frequency domain measurements
- 1 GHz spectrum analyzer standard, 3 GHz optional
- Bandwidths from 100 MHz to 1 GHz
- 2- and 4-channels for time domain measurements
- Sixteen-channel digital input option
- Large 11.6" HD (1920 x 1080 pixel) capacitive touchscreen display
- User interface optimized for touchscreen use
- Sample rates of 2.5 GS/s on all analog channels (5 GS/s on 1 or 2 channels for the MDO34 or MDO32 with the 1 GHz option)
- 10 M points record length on all channels
- Maximum waveform capture rate: 280,000 waveforms/second, with FastAcq: >50,000 waveforms/second with normal operation
- Advanced triggering and analysis: I2C, SPI, USB 2.0, CAN, CAN FD, LIN, FlexRay, RS-232, RS-422, RS-485, UART, I2S, Left Justified (LJ), Right Justified (RJ), TDM, MIL-STD-1553, ARINC429 (with the appropriate option), and Parallel
- Power analysis (optional)
- Arbitrary function generator and 16 digital channels (optional)
- Digital voltmeter and trigger frequency counter free with product registration

3 Series MDO Help, version 20190330-16:00 for Firmware v1.0.0

Product documents and support

Related documents

Use the related documents for more information on instrument functions, how to remotely program or operate the instrument, understand theory of operation, replace suspected modules, and do other tasks.

3 Series MDO documents

To learn about	Use this document
How to use instrument functions	<i>3 Series MDO Help</i> (Tektronix part number 076-0425-xx; Printable version of the instrument Help; available at www.tek.com/downloads) <i>3 Series MDO Installation and Safety Manual</i> (this document, Tektronix part number 071-3608-xx); standard accessory with the instrument. Single document with English, Japanese, and Simplified Chinese languages. Other language versions are available to download from the Tektronix web site.
How to remotely control the instrument	<i>3 Series MDO Programmer Manual</i> (Tektronix part number 077-1498-xx; available at www.tek.com/downloads)
Instrument specifications and procedures to verify the instrument meets specifications	<i>3 Series MDO Specifications and Performance Verification Technical Reference</i> (Tektronix part number 077-1499-xx; available at www.tek.com/downloads)
Instrument theory of operation, troubleshooting, disassembly, and replaceable parts	<i>3 Series MDO Service Manual</i> (Tektronix part number 077-1500-xx; available at www.tek.com/downloads)
Installing the instrument in a rack	<i>RM3 Rack Mount Kit Instructions</i> (Tektronix part number 071-3609-xx; available at www.tek.com/downloads)

Product support and feedback

Tektronix values your feedback on our products. To help us serve you better, please send us your suggestions, ideas, or comments on your instrument, application, or product documentation.

Contact through mail, telephone, or the Web site. See *Contacting Tektronix* for more information or assistance with your product.

When you contact Tektronix Technical Support, please include the following information (be as specific as possible):

General information

- All instrument model numbers
- Hardware options, if any
- Probes used
- Your name, company, mailing address, phone number
- Please indicate if you would like to be contacted by Tektronix about your suggestion or comments

Application specific information

- Software version number
- Description of the problem such that technical support can duplicate the problem
- If possible, save and send the setup files for all the instruments used and the application
- If possible, save and send status messages text files
- If possible, save and send the waveform on which you are performing the measurement as a .wfm file

Accessories

Standard accessories

Item	Quantity	Tektronix part number
3 Series MDO (MDO34, MDO32) Installation and Safety Manual	1	071-3608-xx
Passive Voltage Probe, depends on instrument bandwidth (1 GHz bandwidth) (350 MHz and 500 MHz) (100 MHz and 200 MHz bandwidth)	One per analog channel	TPP1000 TPP0500B TPP0250
Accessory bag	1	016-2144-xx
Power cord	1	Depends on region
Calibration certificate	1	N/A
OpenChoice® Desktop Software (available for download from www.tek.com/software/downloads .)		

Recommended accessories

See the Tektronix Web site (www.tek.com) for the latest information on recommended accessories for this product.

Recommended accessories

Accessory	Tektronix part number
Preamplifier, 12 dB nominal Gain, 9 kHz - 6 GHz	TPA-N-PRE
N-to-TekVPI adapter	TPA-N-VPI
Near field probe set, 100 kHz - 1 GHz	119-4146-00
Flexible monopole antenna	119-6609-00
Service manual, download from Web (English only)	077-0981-xx
TekVPI® to TekProbe™ BNC adapter	TPA-BNC
TekVPI Deskew pulse generator signal source	TEK-DPG
Power measurement deskew and calibration fixture	067-1686-xx
Vector Signal Analysis Software	SignalVu-PC-SVE
GPIO-to-USB adapter	TEK-USB-488
Front protective cover	200-5480-xx
Soft transit case (includes front protective cover)	SC3

Accessory	Tektronix part number
Hard transit case (requires front protective cover)	HC3
Rackmount kit	RM3

Recommended probes

See the Tektronix Web site (www.tek.com) for the latest information on supported probes for this product.

Probes Tektronix offers over 100 different probes to meet your application needs. For a comprehensive listing of available probes, please visit www.tek.com/probes.

Accessory	Tektronix part number
250 MHz, 10X attenuation passive probe with TekVPI® interface	TPP0250
500 MHz, 10X attenuation passive probe with TekVPI® interface	TPP0500B
500 MHz, 2X attenuation passive probe with TekVPI® interface	TPP0502
2.5 kV, 800 MHz, 50X TekVPI® passive high-voltage probe	TPP0850
1 GHz, 10X TekVPI® passive voltage probe, 1.3 Meter cable	TPP1000
500 MHz TekVPI® differential voltage probe, ±42 V differential input voltage	TDP0500
1 GHz TekVPI® differential voltage probe, ±42 V differential input voltage	TDP1000
±6 kV, 100 MHz TekVPI® high-voltage differential probe	THDP0100
±1.5 kV, 200 MHz TekVPI® high-voltage differential probe	THDP0200
±750 V, 200 MHz TekVPI® high-voltage differential probe	TMDP0200
Isolated Probe; 1 GHz, ±50 V, TekVPI, 10 Meter Cable	TIVM1 / L
400 MHz differential active FET probe (Level II TekProbe)	P6246
1 GHz differential active FET probe (Level II TekProbe)	P6427
2.5 kV, 100x high voltage probe (Level II TekProbe)	P5100
20 A AC/DC TekVPI® current probe, 50 MHz BW	TCP0020
30 A AC/DC TekVPI® current probe, 120 MHz BW	TCP0030A
150 A AC/DC TekVPI® current probe, 20 MHz BW	TCP0150
2000 A AC Current probe/BNC	A621
100 A AC/DC Current probe/BNC	A622
AC/DC current probe, DC to 100 MHz, (Requires TCP305A or TCP312A or TCP303 probes)	TCPA300
AC/DC current probe, DC to 50 MHz, (Requires TCP404XL probe)	TCPA400
15MHz AC/DC 150A current probe for TCPA300	TCP303
50MHz AC/DC 50A current probe for TCPA300	TCP305

Accessory	Tektronix part number
100MHz AC/DC 30A current probe for TCPA300	TCP312
2 MHz AC/DC 500A current probe for TCPA400	TCP404XL
100x, 10x, 1x, 0.1x high gain differential amplifier	ADA400A
16 Channel Logic Probe	P6316

RF probes Contact Beehive Electronics to order: <http://beehive-electronics.com/probes.html>

Accessory	Part number
EMC probe set	101A
EMC probe amplifier	150A
Probe cable	110A
SMA probe adapter	0309-0001
BNC probe adapter	0309-0006

Factory options

The 3 Series MDO is configured according to the various options you choose when you purchase your instrument. All options in this section are installed at the factory.

Bandwidth options

The table lists the different bandwidth configuration options for your 3 Series MDO.

Table 1: 3 Series bandwidth options

Option name	Description
3-BW-100	100 MHz Bandwidth for analog channels
3-BW-200	200 MHz Bandwidth for analog channels
3-BW-350	350 MHz Bandwidth for analog channels
3-BW-500	500 MHz Bandwidth for analog channels
3-BW-1000	1 GHz Bandwidth for analog channels

Digital channels option

The MSO option provides 16 digital channels to simultaneously view analog and digital signals on your oscilloscope.

Table 2: 3 Series MSO option

Option name	Description
3-MSO	Adds 16 digital channels to the oscilloscope. The option includes a P6316 digital probe and accessories.

Spectrum analyzer frequency range options

The spectrum analyzer options increase the input frequency range and capture bandwidth of the integrated spectrum analyzer. With increased spectrum analyzer bandwidth you can capture higher-frequency signals and view a broader spectrum. The 1 GHz spectrum analyzer comes standard on all models. The 3 GHz spectrum analyzer is optional.

Table 3: 3 Series spectrum analyzer options

Option name	Description
3-SA3	Increase spectrum analyzer input frequency range to 9 kHz to 3 GHz and capture bandwidth to 3 GHz

Arbitrary Function Generator (AFG) option

The AFG option adds a 50 MHz AFG function to your oscilloscope.

- AFG features**
- Function types: Arbitrary, Sine, Square, Pulse, Ramp, Triangle, DC Level, Gaussian, Lorentz, Exponential Rise/Fall, Sin(x)/x, Random Noise, Haversine, Cardiac
 - Maximum frequency: 50 MHz (Sine)
 - Maximum output amplitude: 5 Vp-p
 - Maximum sample rate: 250 MS/s
 - Arbitrary function record length: 128K samples
 - AM and FM modulation

Table 4: 3 Series AFG option

Option name	Description
3-AFG	Adds a arbitrary function generator with 13 predefined waveforms and arbitrary waveform generation.

Enhanced instrument security

The enhanced instrument security option provides the highest level of instrument security. This option enables password protecting and disabling of all communication ports and firmware upgrades. This option configures the oscilloscope hardware to easily declassify the oscilloscope. This option must be ordered at the same time you order an instrument. You cannot order this option as a field-installable upgrade, as the option requires hardware reconfiguration.

Table 5: Enhanced instrument security pre-installed option

Install option name	Description
3-SEC	Enhanced instrument security to enable password protected control of turning on/off all instrument ports and instrument firmware update functionality.

Serial bus decode and trigger options

Serial bus and trigger options provide bus decode display and triggering for testing and analysis of industry standard serial buses.

Table 6: 3 Series serial bus options

Option name	Description
3-SRAERO	Adds aerospace serial triggering and analysis (MIL-STD-1553, ARINC429)
3-SRAUDIO	Adds audio serial triggering and analysis (I ² S, LJ, RJ, TDM)
3-SRAUTO	Adds automotive serial triggering and analysis (CAN, CAN FD, LIN, FlexRay)
3-SRCOMP	Adds computer serial triggering and analysis (RS-232/422/485/UART)
3-SREMBD	Adds embedded serial triggering and analysis (I ² C, SPI)
3-SRUSB2	Adds USB serial triggering and analysis (USB 2.0 LS, FS, HS)

Power Analysis option

The power analysis option enables analysis of many different power measurements: power quality, switching loss, harmonics, modulation, ripple, slew rate (di/dt, dv/dt), and safe operating area (SOA).

Table 7: 3 Series power option

Upgrade option name	Description
3-PWR	Adds power measurement and analysis.

Application bundle

The application bundle option includes all of the serial bus decode and trigger options and the power analysis option.

Table 8: 3 Series bundle option

Option name	Description
3-BND	Adds all the serial options and power analysis option as an application bundle

Power cord options

These options let you order the oscilloscope with a country- or region-specific power cord.

Power cord options

These options are ordered when ordering the oscilloscope.

Option name	Description
A0	North America Power Cord
A1	Universal EURO Power Cord
A2	United Kingdom Power Cord
A3	Australia Power Cord
A4	240 V North America Power Cord
A5	Switzerland Power Cord
A6	Japan Power Cord
A8	None provided, product set to operate at 120 V
A9	None provided, product set to operate at 230 V
A10	China Power Cord
A11	India Power Cord

Option name	Description
A12	Brazil Power Cord
A99	No Power Cord or AC Adapter

Service options

Service options improve the level of service response. You can order service options when you purchase an oscilloscope, or purchase a service option at a later date.

Service options

Option name	Description
G3	Three Year Gold Care Plan. Includes expedited repair of all product failures including ESD and EOS, access to a loaner product during repair or advanced exchange to reduce downtime, priority access to Customer Support among others.
G5	Five Year Gold Care Plan. Includes expedited repair of all product failures including ESD and EOS, access to a loaner product during repair or advanced exchange to reduce downtime, priority access to Customer Support among others.
R3	Standard Warranty Extended to 3 Years. Covers parts, labor and 2-day shipping within country. Guarantees faster repair time than without coverage. All repairs include calibration and updates. Hassle free-a single call starts the process.
R5	Standard Warranty Extended to 5 Years. Covers parts, labor and 2-day shipping within country. Guarantees faster repair time than without coverage. All repairs include calibration and updates. Hassle free-a single call starts the process.
T3	Three year Total Protection Plan. Includes preventative maintenance, and repair or replacement coverage from wear and tear, accidental damage, and ESD or EOS damage. Includes a five-day turnaround time and priority access to customer support.
T5	Five year Total Protection Plan. Includes preventative maintenance, and repair or replacement coverage from wear and tear, accidental damage, and ESD or EOS damage. Includes a five-day turnaround time and priority access to customer support.
C3	Three-year calibration service. Includes traceable or functional verification where applicable, for recommended calibrations. Coverage includes the initial calibration plus two years calibration coverage.
C5	Five-year calibration service. Includes traceable or functional verification where applicable, for recommended calibrations. Coverage includes the initial calibration plus four years calibration coverage.
D1	Factory calibration data report for the instrument.
D3	Three years of calibration data reports (with Option C3)

Factory options

Option name	Description
D5	Five years of calibration data reports (with Option C5)
IN	Product installation service
IF	Upgrade installation service
IFC	Service installation and calibration
IFCN	Service installation and calibration, includes incoming calibration.

Option upgrades

The 3 Series MDO products offer a number of ways to add functionality after the initial purchase.

Post-purchase instrument options

Option upgrades add functionality to your 3 Series MDO after you receive it from the factory. The upgrades are enabled by installing a software license key that is specific to the model and serial number of your oscilloscope. The license key from Tektronix is provided with the purchase of your options.

Table 9: Instrument upgrade options

Option name	Description
SUP3 AFG	Adds the arbitrary function generator to any 3 Series MDO product
SUP3 DVM	Adds a digital voltmeter and frequency counter. This option is free when you register your product. To register go to: www.tektronix.com/register3mdo
SUP3 MSO	Adds 16 digital channels and includes a P6316 digital probe and accessories
SUP3 SA1	Free with registration. Adds a spectrum analyzer; frequency range from 9 kHz to 1 GHz and capture bandwidth to 1 GHz
SUP3 SA3	Adds a spectrum analyzer; frequency range from 9 kHz to 3 GHz and capture bandwidth to 3 GHz
SUP3 BND	Adds an application bundle (includes all serial options and power analysis option)
SUP3 SRAERO	Adds aerospace serial triggering and analysis (MIL-STD-1553, ARINC429)
SUP3 SRAUDIO	Adds audio serial triggering and analysis (I ² S, LJ, RJ, TDM)
SUP3 SRAUTO	Adds automotive serial triggering and analysis (CAN, CAN FD, LIN, FlexRay)
SUP3 SRCOMP	Adds computer serial triggering and analysis (RS-232/422/485/UART)
SUP3 SREMBD	Adds embedded serial triggering and analysis (I ² C, SPI).
SUP3 SRUSB2	Adds USB serial triggering and analysis (USB 2.0 LS, FS, HS)
SUP3 PWR	Add power measurement and analysis

Option name	Description
SUP3 T3	Three Year Total Protection Plan, includes repair or replacement coverage from wear and tear, accidental damage, ESD or EOS plus preventative maintenance, including a 5 day turnaround time and priority access to customer support
SUP3 T5	Five Year Total Protection Plan, includes repair or replacement coverage from wear and tear, accidental damage, ESD or EOS plus preventative maintenance, including a 5 day turnaround time and priority access to customer support

Bandwidth upgrade options

Instrument bandwidth can be upgraded on any 3 Series MDO product after initial purchase. Each upgrade product increases analog bandwidth and spectrum analyzer frequency range. Bandwidth upgrades are purchased based on the combination of the current bandwidth and the desired bandwidth. Software option key depends on the instrument model and serial number combination. Bandwidth upgrades up to 500 MHz can be performed in the field, while upgrades to 1 GHz require installation at a Tektronix service center.

Table 10: MDO32 bandwidth upgrades

Option name	Bandwidth before upgrade	Bandwidth after upgrade
SUP3 BW1T22	100 MHz	200 MHz
SUP3 BW1T32	100 MHz	350 MHz
SUP3 BW1T52	100 MHz	500 MHz
SUP3 BW1T102	100 MHz	1 GHz
SUP3 BW2T32	200 MHz	350 MHz
SUP3 BW2T52	200 MHz	500 MHz
SUP3 BW2T102	200 MHz	1 GHz
SUP3 BW3T52	350 MHz	500 MHz
SUP3 BW3T102	350 MHz	1 GHz
SUP3 BW5T102	500 MHz	1 GHz

Table 11: MDO34 bandwidth upgrades

Option name	Bandwidth before upgrade	Bandwidth after upgrade
SUP3 BW1T24	100 MHz	200 MHz
SUP3 BW1T34	100 MHz	350 MHz
SUP3 BW1T54	100 MHz	500 MHz
SUP3 BW1T104	100 MHz	1 GHz
SUP3 BW2T34	200 MHz	350 MHz
SUP3 BW2T54	200 MHz	500 MHz

Option name	Bandwidth before upgrade	Bandwidth after upgrade
SUP3 BW2T104	200 MHz	1 GHz
SUP3 BW3T54	350 MHz	500 MHz
SUP3 BW3T104	350 MHz	1 GHz
SUP3 BW5T104	500 MHz	1 GHz

How to install an option license

Use this process install an option license to enable specific instrument features. Option licenses provide advanced functions for specific standards or measurement requirements.

Prerequisite:

- You need the license key from Tektronix that is provided with your purchase. A single license key is valid only for the specific model number and serial number of the instrument for which it was purchased; it will not work on any other instrument. The single license key does not affect options that were factory installed or any other upgrades that you may have already purchased and installed.
- These instructions only support options that are enabled by installing a software license key. Some product upgrades, such as 3 Series MDO bandwidth upgrades to 1 GHz, are not supported by this procedure. These upgrades either have their own installation instructions, or require that you send the instrument to a Tektronix service center for new hardware and calibration.

1. Select **Help > About**.
2. Tap **Install License** to open the Install License dialog box.
3. Double-tap the **Enter License Key** field to open the virtual keyboard.
4. Use the virtual keyboard to enter the license key. The key is not case sensitive.
5. Tap **OK**. The instrument installs the license and returns to the **About** screen.
6. Power cycle the instrument to enable the installed option(s).
7. Return to the **Help > About** menu to verify that the Enabled status for the option is **Yes**.
8. If you installed a bandwidth upgrade, remove the model/bandwidth label from the lower-left corner of the front panel and install the new model/bandwidth label that your received as part of the upgrade purchase. If you installed a bandwidth upgrade, run signal path compensation (Utility > Calibration > Run SPC).

Install your instrument

Check shipped accessories

Make sure that you received everything you ordered. If anything is missing, contact Tektronix Customer Support. In North America, call 1-800-833-9200. Worldwide, visit www.tek.com to find contacts in your area.

Check the packing list that came with your instrument to verify that you have received all standard accessories and ordered items. If you purchased factory options, tap **Help** > **About** to confirm that the option(s) are listed in the **Installed Options** table.

Standard accessories

Item	Quantity	Tektronix part number
3 Series MDO (MDO34, MDO32) Installation and Safety Manual	1	071-3608-xx
Passive Voltage Probe, depends on instrument bandwidth (1 GHz bandwidth) (350 MHz and 500 MHz) (100 MHz and 200 MHz bandwidth)	One per analog channel	TPP1000 TPP0500B TPP0250
Accessory bag	1	016-2144-xx
Power cord	1	Depends on region
Calibration certificate	1	N/A
OpenChoice® Desktop Software (available for download from www.tek.com/software/downloads .)		

Safely rotate the handle

Use the correct process to eliminate the chance of pinching your thumb or rear-panel-connected cables while rotating the handle.



CAUTION. *Hold the top of the handle to rotate the handle on the instrument. Do not hold the handle from the sides and rotate, as this can pinch the base of your thumb between the handle and the case.*

If you have routed any cables between the handle and the case, be careful when rotating the handle so that you do not pinch the cables.

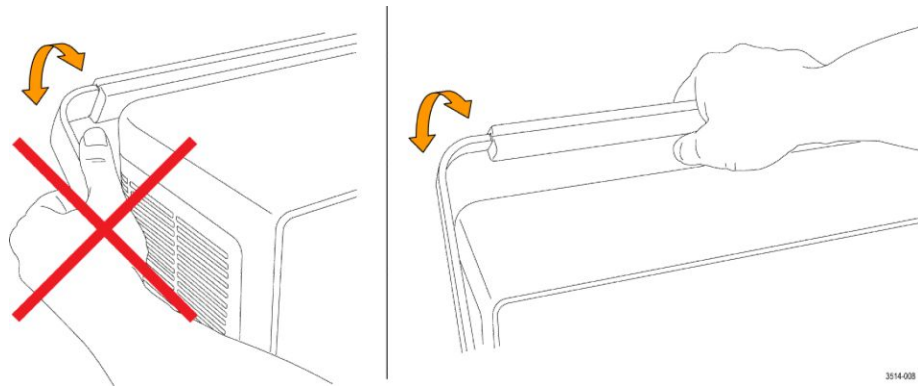

3514-008

Operating requirements

Use the oscilloscope within the required operating temperature, power, altitude, and signal input voltage ranges to provide the most accurate measurements and safe instrument operation.

Environment requirements

Characteristic	Description
Operating temperature	-10 °C to +55 °C (+14 °F to +131 °F) For proper cooling, keep the sides and rear of the instrument clear of obstructions for 2 inches (51 mm).
Operating humidity	5% to 90% relative humidity (% RH) up to +40 °C (+104 °F), Noncondensing. 5% to 60% RH above +40 °C up to +55 °C (+104 °F to +131 °F), Noncondensing.
Operating altitude	Up to 3000 meters (9842 feet)

Power requirements

Characteristic	Description
Power source voltage	100 V - 240 V _{AC RMS} , ±10%, single phase
Power source frequency	50/60 Hz, 100-240 V 400 Hz ±10% at 100 to 132 V

Input signal requirements

Keep the input signals within allowed limits to ensure the most accurate measurements and prevent damage to the analog and digital probes or instrument.

Make sure that input signals are within the following requirements.

Table 12: Maximum analog input

Input	Description
Analog input channels, 1 M Ω setting, maximum input voltage at BNC	300 V _{RMS} Measurement Category II De-rate at 20 dB/decade between 4.5 MHz and 45 MHz, De-rate 14 db between 45 MHz and 450 MHz. Above 450 MHz, 5 V _{RMS} .
Analog input channels, 50 Ω setting, maximum input voltage at BNC	5 V _{RMS} with a peak at ± 20 V. (DF \leq 6.25%).
RF input maximum input voltage	Average Continuous Power: +20 dBm (0.1 W) DC maximum before damage: ± 40 VDC Max no damage +33 dBm (2 W) CW Peak Pulse Power: +45 dBm (32 W) Peak Pulse Power defined as <10 μ s pulse width, <1% duty cycle, and reference level of \geq +10 dBm

Table 13: Maximum input with a P6316 Digital Probe

Input	Description
Threshold Accuracy	$\pm(100 \text{ mV} + 3\% \text{ of threshold setting after calibration})$
Threshold Range	+25 V to -15 V
Maximum nondestructive input signal to probe	+30 V to -20 V
Minimum signal swing	500 mV _{peak-to-peak}
Input resistance	101 k Ω
Input capacitance	8.0 pF typical
Pollution Degree	2, indoor use only
Humidity	5% to 95% relative humidity

Powering the oscilloscope

Use this procedure to connect the oscilloscope to line power and power on and off the oscilloscope. Always connect the oscilloscope to AC power using the power cord that shipped with the instrument.

Prerequisite: Use the AC power cord that shipped with your oscilloscope.

1. Connect the supplied power cord to the oscilloscope power connector.

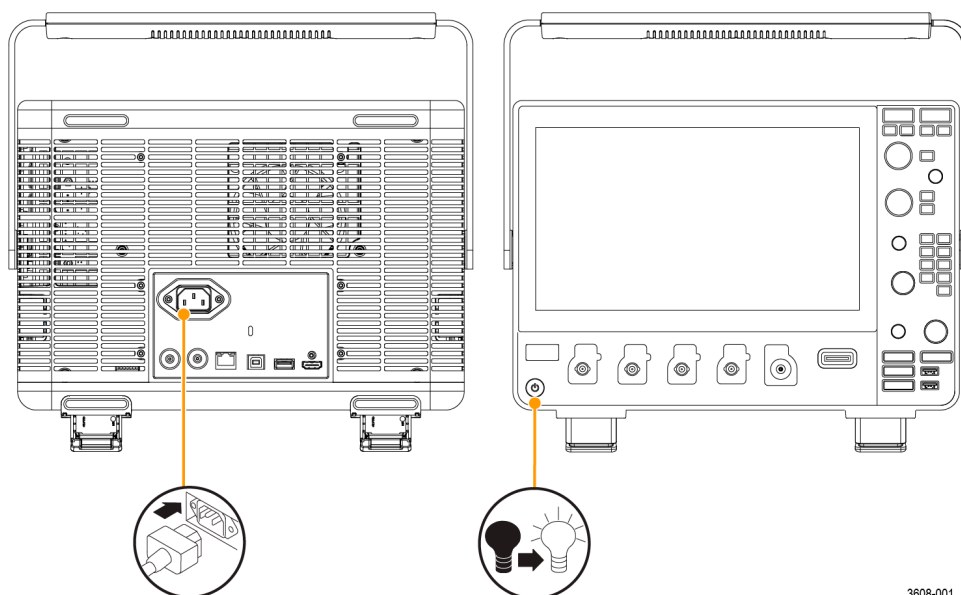

3608-001

Figure 1: Power cord connector and power standby switch

2. Connect the power cord to an appropriate AC mains source.
Power is supplied to the power supply and some other boards whenever the AC power cord is connected to a live mains circuit, putting the instrument in standby mode.
3. Push the front panel power button to power the instrument on and off.
The power button color indicates instrument power states:
Unlit – no AC power applied
Yellow – standby mode
Blue – powered on
4. To completely remove power from the instrument, disconnect the power cord.

Check that the oscilloscope passes power-on self tests

Power-on self tests verify that all oscilloscope modules are working correctly after power up.

1. Power on the oscilloscope and wait until the oscilloscope screen appears.
2. Select **Utility > Self Test** from the top-edge Menu bar to open the **Self Test** configuration menu.
3. Check that the status of all power-on self tests are **Passed**.

If one or more power-on self tests shows **Failed**:

- a. Power cycle the oscilloscope.
- b. Tap **Utility > Self Test**. If one or more power-on self tests still shows **Failed**, contact Tektronix Customer Support.

Secure (lock) the oscilloscope

Lock an oscilloscope to a test bench or equipment rack to prevent property loss.

Attach a standard laptop security lock to the rear panel of the oscilloscope, to secure the oscilloscope to a workbench, rack, or other location.

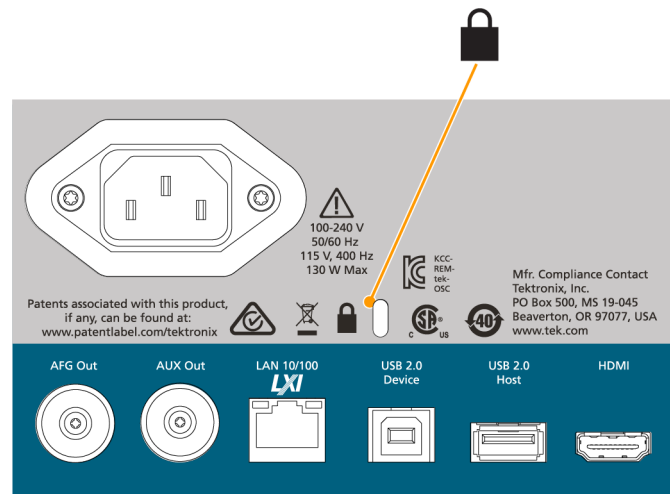

Connecting probes

Probes and cables connect the oscilloscope to your device under test (DUT). Use a probe that best matches your signal measurement needs.

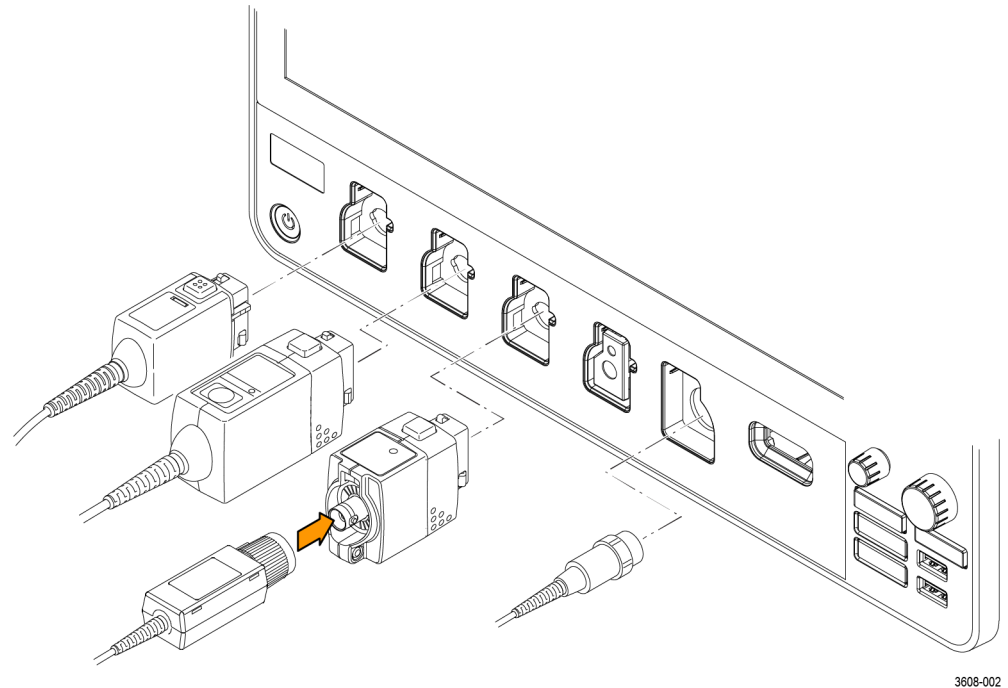

3608-002

Figure 2: Connecting probes to the instrument

1. Tektronix Versatile Probe Interface (TekVPI)

These probes support two-way communication with the oscilloscope through on-screen menus and remotely through programmable support. The remote control is useful in applications like ATE where you want the system to set probe parameters.

2. Tektronix Versatile Probe Interface (TekVPI) for Passive Probes

These probes build upon the functionality of the TekVPI interface. Each probe is matched with its corresponding oscilloscope channel, allowing the oscilloscope to optimize the signal input path. This provides AC compensation across the frequency band.

3. TPA-BNC Adapter

The TPA-BNC Adapter allows you to use TEKPROBE II probe capabilities, such as providing probe power and passing scaling and unit information to the oscilloscope.

4. BNC Interfaces

Some of these use TEKPROBE capabilities to pass the waveform signal and scaling to the oscilloscope. Some only pass the signal and there is no other communication.

5. Logic Probe Interface

The P6316 probe provides 16 channels of digital (logical one or zero) information.

6. The TPA-N-VPI Adapter allows you to use TekVPI probes with the RF input.

Connect TPP0250, TPP0500B, TPP1000, TekVPI+, TekVPI, or other supported Tektronix analog probes by pushing them into an input connector. The probe base latch locks with a 'click' when the probe is fully seated.

TekVPI probes automatically set the channel input parameters for that probe (bandwidth, attenuation, termination, and so on). If a probe has a **Menu** button, push that button to open an on-screen configuration menu. Follow instructions provided with active probes to set their parameters (auto zero, degauss, and so on).

Connect a BNC probe or cable by pushing it onto a channel BNC bayonet connector and turn the lock mechanism clockwise until it locks.

For more information on the many probes available for use with 3 Series MDO oscilloscopes, visit the Oscilloscope Probe and Accessory Selector Tool on the Tektronix website at www.tektronix.com.

NOTE. *Connecting a probe does not automatically enable that channel (make it active). Use the instrument controls or programmatic interface to turn on a channel and open its configuration menu to verify or change probe or cable settings (bandwidth, attenuation, termination and so on).*

Rackmount information

The optional RM3 Rackmount Kit lets you install the oscilloscope in standard equipment racks. The rack mount requires six rack units (6U) of space to install.

Contact Tektronix Customer Support to purchase the rackmount kit option RM3. Follow the instructions that come with the rackmount kit (*RM3 Rackmount Kit Instructions*, Tektronix part number 071-3609-xx).

Make sure to allow at least two inches of clearance on the sides for air ventilation and on the back for any cables you attach to the rear panel.

Getting acquainted with your instrument

The following content provides a high-level description of the instrument controls and user interface.

Refer to the instrument help for detailed information on using the controls and user interface to display waveforms and take measurements.

Front panel controls and connectors

The front panel controls provide direct access to key instrument settings such as vertical, horizontal, trigger, and cursors. The connectors are where you input signals with probes or cables or insert USB devices.

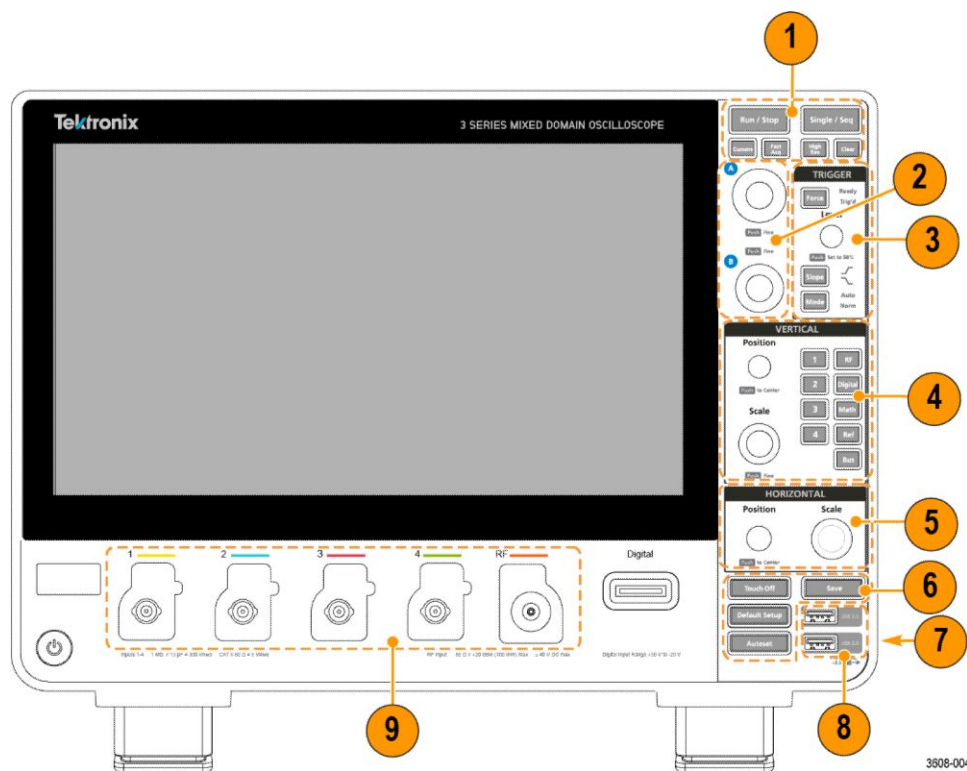

Figure 3: 3 Series MDO controls

1. Acquisition and Cursors controls:



- **Run/Stop** starts and stops waveform acquisition. The button color indicates the acquisition status (green = running and acquiring; red = stopped). When stopped, the oscilloscope shows waveforms from the last completed acquisition. The Run/Stop button on the screen also shows the acquisition status.
- **Cursors** button turns cursors on or off. Use the Multipurpose knobs to move the cursors. Double-tap the cursor readouts or on a cursor bar (line) to open the configuration menu to set cursor types and functionality. See [Display and configure cursors](#) on page 85.
- **Fast AcqTM** enables or disables the fast acquisition mode. FastAcq provides high-speed waveform capture that reduces the dead time between waveform acquisitions, enabling the capture and display of transient events such as glitches and runt pulses. It is helpful in finding elusive signal anomalies. Fast acquisition mode can also display waveform phenomena at an intensity that reflects their rate of occurrence.
- **Single/Seq** enables making a single waveform acquisition, or a specified number of acquisitions (as set in the **Acquisition** configuration menu). Pushing **Single/Seq** turns off **Run/Stop** mode and takes a single acquisition. The button color indicates the acquisition status (quick green flash = single acquisition acquired; solid green = waiting for trigger event). Pushing **Single/Seq** again takes another single acquisition.
- **High Res** mode calculates the average of all the samples for each acquisition interval. High Res provides a higher-resolution, lower-bandwidth waveform.
- **Clear** deletes the current acquisitions and measurement values from memory.

2. Multipurpose knobs:

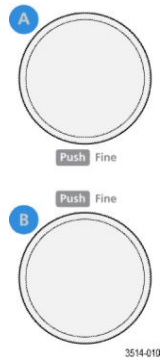

- **Multipurpose knobs (A, B)** Multipurpose knobs A and B move cursors, adjust the zoom, and set parameter values in configuration menu input fields. Selecting a menu field that can use a Multipurpose knob assigns the indicated knob to change the value in that input field. The ring around each knob lights when you can use that knob to do an action.

Push a Multipurpose knob to enable the **Fine** mode for making smaller increment changes. Push the knob again to exit **Fine** mode.

NOTE. *If you have a mouse attached, pressing the mouse wheel toggles between **Coarse** and **Fine** adjustments.*

3. Trigger controls:

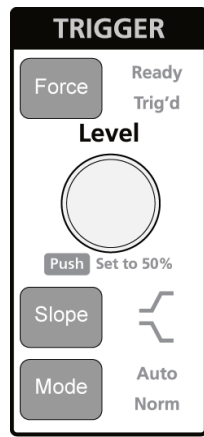

- **Force** forces a trigger event at a random point in the waveform and captures the acquisition.
- **Level** sets the amplitude level that the signal must pass through to be considered a valid transition. The color of the **Level** knob indicates the trigger source except for dual-level triggers. The **Level** knob is disabled when the trigger type requires two level settings or other trigger qualifiers (set from the **Trigger** configuration menu). Push the knob to set the threshold level to 50% of the peak-to-peak amplitude range of the signal.
- **Slope** sets the signal transition direction to detect for a trigger (low to high, high to low, or either direction). Push the button to cycle through the selections. The **Slope** button is disabled when the trigger type requires other slope qualifiers (set from the **Trigger** configuration menu).
- **Mode** sets how the instrument behaves in the absence or presence of a trigger event:
 - **Auto** trigger mode enables the instrument to acquire and display a waveform whether or not a trigger event occurs. If a trigger event occurs, the instrument displays a stable waveform. If a trigger event does not occur, the instrument forces a trigger event and acquisition and displays an unstable waveform.
 - **Normal** trigger mode sets the instrument to acquire and display a waveform only when there is a valid trigger event. If no trigger occurs, the last waveform record acquired remains on the display. If no last waveform exists, no waveform is displayed.

4. Vertical controls:

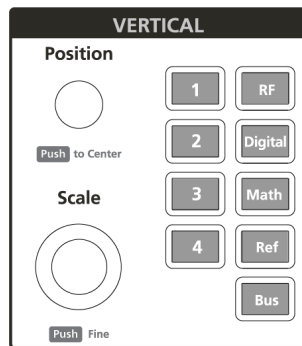

3608-011

- **Position** moves the selected waveform up or down on the screen. The color of the **Position** knob indicates which waveform the knob is controlling. Push the knob to center the waveform handle on the display.
- **Scale** sets the amplitude units per vertical graticule division of the selected waveform. The scale values are shown on the waveform badge. The color of the **Scale** knob indicates which waveform the knob is controlling.
- **Channel** buttons turn on (display), select, or turn off a channel, as follows:
 - If the channel is not displayed, pushing a Channel button turns on that channel in the Waveform view.
 - If the channel is on the screen and is not selected, pushing that channel's button selects that channel.
 - If the channel is on the screen and is also selected, pushing that channel's button turns that channel off (removes it from Waveform view).
- The **Math** button adds or selects a Math waveform on the Waveform view, as follows:
 - If no Math waveform exists, pushing the **Math** button adds a Math waveform to the Waveform view and opens the Math configuration menu.
 - If a Math waveform is displayed but not selected, pushing the button selects the Math waveform.
 - If a Math waveform is displayed and selected, pushing the button turns off the Math waveform (removes it from Waveform view). Push the button again to display the waveform.
- The **Ref** button adds or selects a Reference (saved) waveform on the Waveform view, as follows:
 - If no Reference waveform exists, pushing the **Ref** button opens the **Browse Waveform Files** configuration menu. Navigate to and select

a waveform file (*.isf) and tap **Recall** to load and display the reference waveform.

- If only one Reference waveform is displayed, pushing the button turns off the Reference waveform (removes it from the Waveform View). Push the button again to display the waveform.
- If two or more Reference waveforms are displayed, pushing the button cycles through selecting each Reference waveform.
- The **Bus** button adds or selects a bus waveform on the Waveform view, as follows:
 - If no Bus waveform exists, pushing the **Bus** button adds a Bus waveform to the Waveform view and opens the Bus configuration menu.
 - If only one Bus waveform is displayed, pushing the button turns off the Bus waveform (removes it from Waveform view).
 - If two Bus waveforms are displayed, pushing the button cycles through selecting each Bus waveform.
- The **RF** button adds the RF waveform on the Waveform view and switches from the time domain to the frequency domain. All time domain waveforms are turned off and the spectrum analyzer is turned on. When you switch back to the time domain, the time domain waveforms are restored.
- The **Digital** button adds or selects a digital waveform on the Waveform view
 - If the digital channels are not displayed, pushing a **Digital** button turns on the channels in the Waveform view.
 - If the digital channels are on the screen, but not selected, pushing the **Digital** button selects the digital channels.
 - If the digital channels are on the screen and are also selected, pushing the **Digital** button turns the digital channels off (removes them from Waveform view).

5. Horizontal controls:

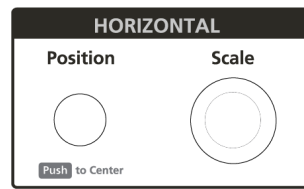

3608-012

- **Position** moves the waveform from side to side on the screen (changing the trigger point position in the waveform record). Push the knob to center the trigger event to the center of the graticule.
- **Scale** sets the time per major horizontal graticule division and samples/second parameters for the oscilloscope. Scale applies to all waveforms.

6. Miscellaneous controls:

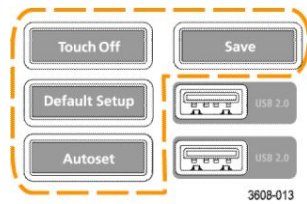

- **Touch Off** turns touchscreen capability off. The **Touch Off** button is lighted when the touchscreen is turned off.
- **Save** is a one-push save operation that uses the current **File > Save As** settings to save screen shots (including open menus and dialog boxes), waveform files, instrument settings, and so on, as follows:
 - If a **File > Save** or **File > Save As** operation has occurred since the last instrument startup, pushing **Save** saves the file types to the location last set in the **Save As** configuration menu.
 - If no file save operation has occurred since the last instrument startup, pushing **Save** opens the **Save As** configuration menu. Select a tab to select the type of file to save (Screen Capture, Waveform, and so on), set any associated parameters, and where to save it, and select **OK**. The specified file or files are saved. The next time you push **Save**, the same type of files are saved.
 - **Screen Captures** capture the entire screen, including displayed configuration menus and dialog boxes.
- **Default Setup** restores the oscilloscope settings (horizontal, vertical, scale, position, and so on) to the default settings. Default Setup does not change items found in the User Preferences menu.
- **Autoset** automatically displays a stable waveform. See [Quickly display a waveform \(autoset\)](#) on page 68.

7. Ground and Probe Compensation connectors:

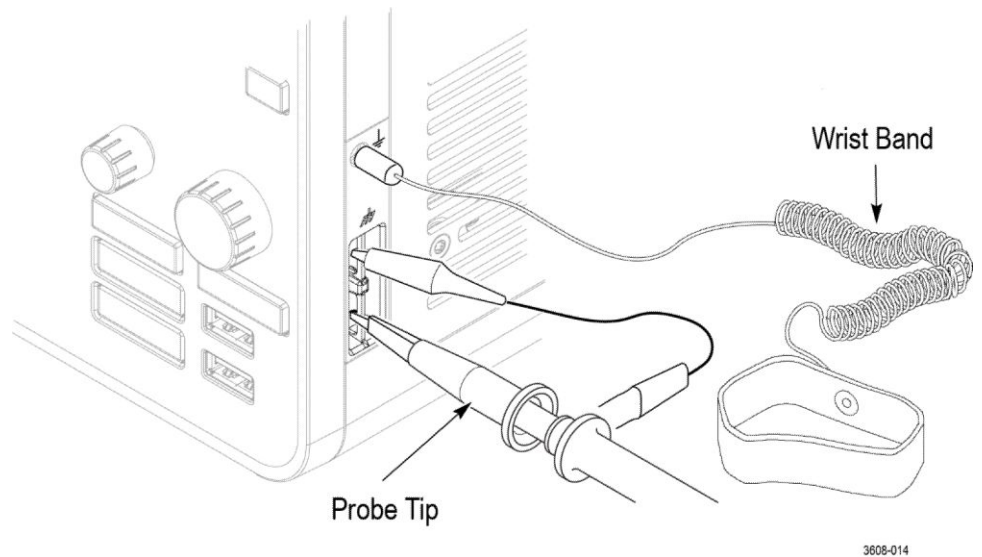

- The Ground and Probe Compensation connectors are located at the lower right side of the instrument, near the front panel. The Ground connector (the small hole in the case) provides an electrically grounded (through a resistor) connection point to attach an anti-static wrist strap to reduce electrostatic damage (ESD) while you handle or probe the DUT.
- The Probe Compensation connections provide a ground connector (upper tab) and 1 kHz square wave source (lower tab) for adjusting the high-frequency response of a passive probe (probe compensation). The oscilloscope uses this signal to automatically compensate supported probes, including the ones that ship with the product. See [Compensate TPP0250, TPP0500B, or TPP1000 probes](#) on page 58.

8. USB Host ports (USB 2.0):

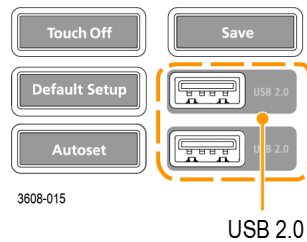

- USB ports are located at the lower right corner of the front panel and on the rear panel. Connect USB flash drives to which you can save or recall data (such as instrument software updates, waveforms, settings, and screen captures) or connect peripheral devices such as a mouse or keyboard.

9. Probe connectors:

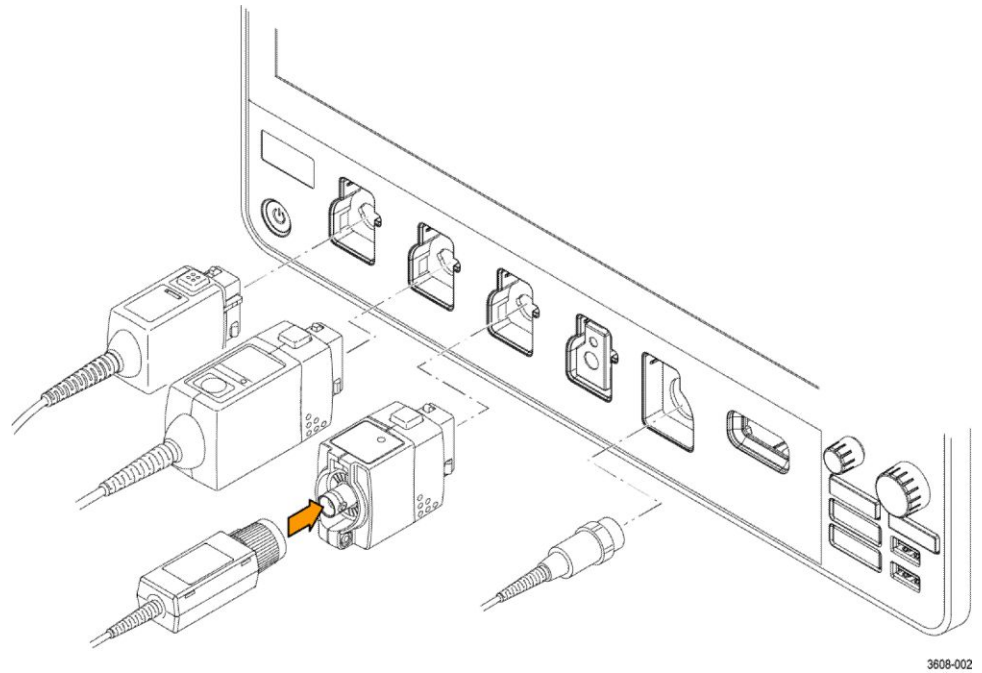

- Analog input connectors support all TekVPI+ and TekVPI measurement probes, BNC passive probes, the P6316 Logic Probe, and BNC cables. See [Connecting probes](#) on page 23.

Rear panel connections

The rear panel connections supply power to the oscilloscope and provide connectors for network, USB devices, video, reference signals, and the AFG output.

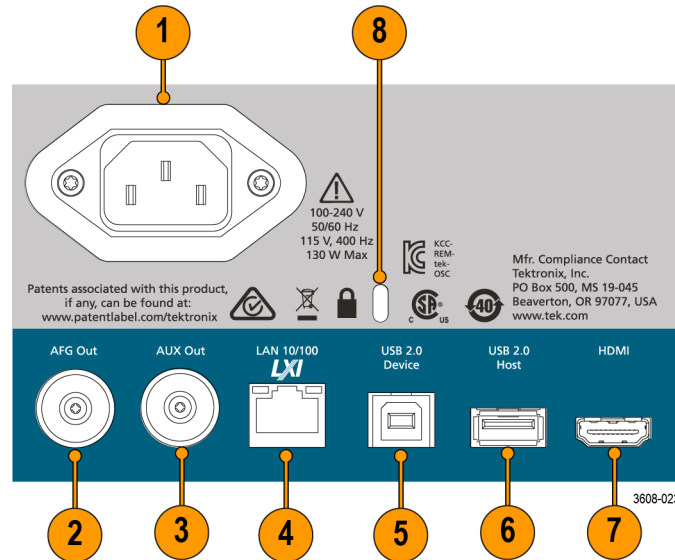

1. **Power cord** connector. Use only the power cord specified for this product and certified for the country of use.
2. **AFG Out** is the signal output for the optional Arbitrary Function Generator (AFG) feature.
3. **AUX Out** generates a signal transition on a trigger event or outputs a synchronization signal from the AFG.
4. **LAN** connector (RJ-45) connects the oscilloscope to a 10/100 Base-T local area network.
5. **USB Device** port lets you connect to a PC to remotely control the oscilloscope using the USBTMC protocol.
6. **USB Host** port lets you connect a USB memory device, keyboard, or mouse.
7. **HDMI** output lets you connect an external monitor or projector to show the oscilloscope screen.
8. **Security** lock connector lets you use a standard PC/laptop lock cable to secure the oscilloscope to a work bench or other location.

The user interface screen

The touchscreen user interface contains waveforms, measurement readouts, and touch-based controls to access all oscilloscope functions.

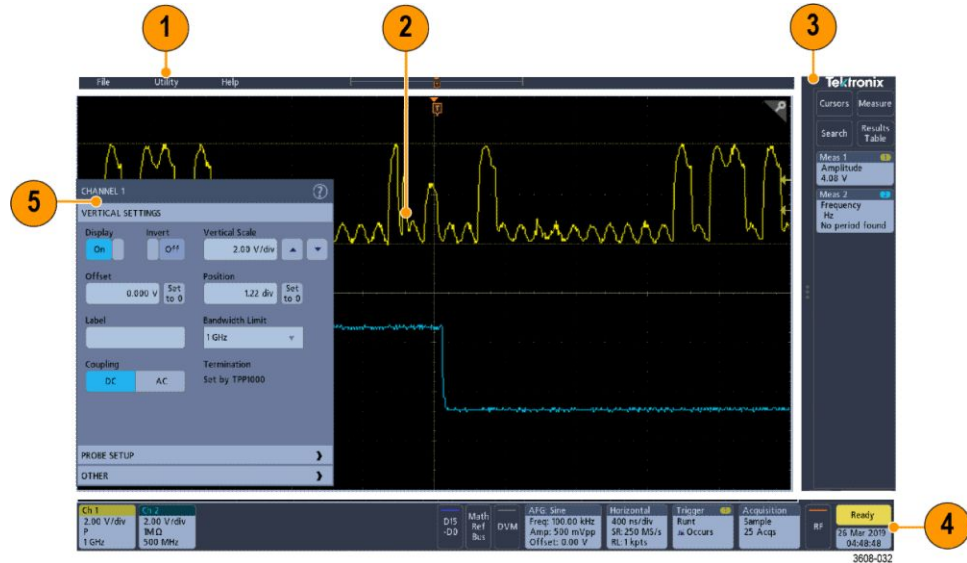

1. The **Menu bar** provides menus for typical operations including:
 - Saving, loading, and accessing files
 - Setting oscilloscope display and measurement preferences
 - Configuring network access
 - Running self tests
 - Erasing measurement and settings memory (TekSecure™)
 - Loading option licenses
 - Opening a Help viewer
2. The **Waveform View** area displays analog, digital, math, reference, and bus waveforms. The waveforms include waveform handles (identifiers), trigger position, and level(s) indicators. See [Identifying items in the time domain display](#) on page 37.
3. The **Results Bar** contains controls for displaying cursors, adding result tables to the screen, and adding measurements to the Results bar. The controls are:
 - The **Cursors** button displays on-screen cursors. Touch and drag or use the Multipurpose knobs to move the cursors. Double-tap on a cursor or on the cursor readouts to open a configuration menu to set cursor types and related functions.
 - The **Measure** button opens a configuration menu from which to select and add up to four measurements to the Results bar. Each measurement you add has a separate badge. Double-tap a measurement badge to open its configuration menu.
 - The **Results Table** button adds a Measurement, Bus, Search, and Harmonics results table to the screen. The Measure tab displays all

measurements present in the Results bar. The Bus tab displays bus decode information for displayed bus waveforms. The Search tab displays search event information. The Harmonics tab displays harmonic measurement results.

- The **Search** button lets you detect and mark a waveform where specified events occur. Tap **Search** to open a Search configuration menu and set the search conditions for analog and digital channels. Search badges are added to the **Results Bar**.
 - The **Measurement** and **Search** badges show measurement and search results and are displayed in the **Results Bar**. See [Badges](#) on page 44. See [Add a measurement](#) on page 77. See [Add a search](#) on page 82.
4. The **Settings Bar** contains System badges for setting Horizontal, Trigger, Acquisition, and Date/Time parameters; **Inactive Channel** buttons to turn on channels; **Math/Ref/Bus** button to add math, reference, and bus waveforms to the display; and Channel and Waveform badges that let you configure the individual waveform parameters. Tap a channel or waveform button to add it to the screen and display a badge. Double-tap a badge to open its configuration menu. See [Badges](#) on page 44.
 5. **Configuration Menus** let you quickly change the parameters of the selected user interface item. You can open configuration menus by double-tapping on badges, screen objects, or screen areas. See [Configuration menus](#) on page 50.

Identifying items in the time domain display

Each area of the user interface has a specific function that helps manage information or controls. This topic shows and describes the key user interface elements.

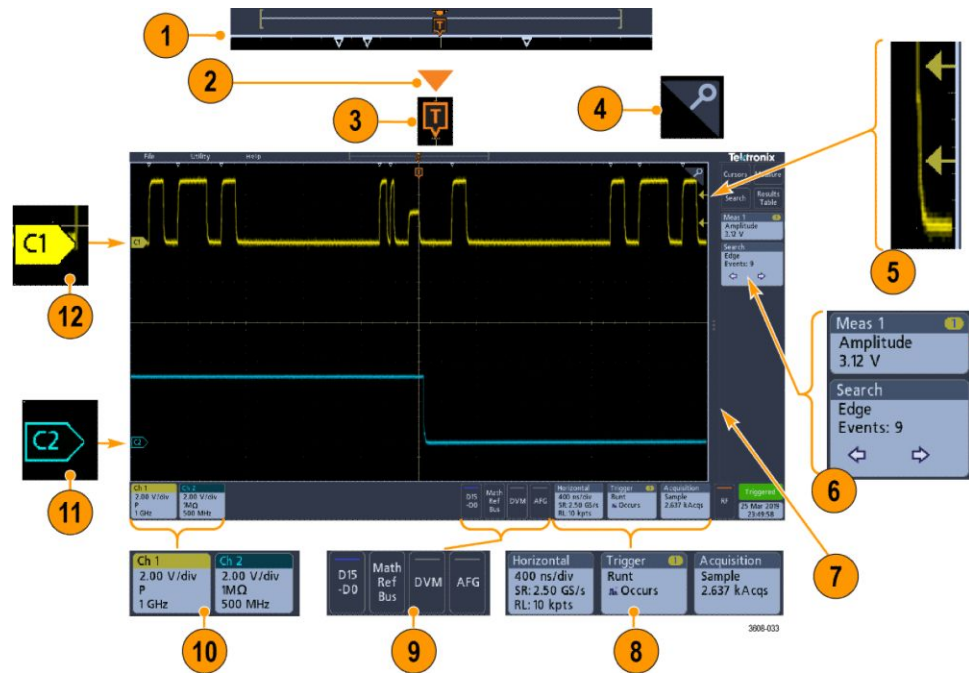

1. The Waveform Record View is a graphical high-level view of the overall acquisition, how much of the acquisition is on the screen (shown in brackets), the location of key time events including the trigger event, and the current position of waveforms cursors.



If you are changing the horizontal time scale while the oscilloscope acquisition is stopped, the brackets change position to show the part of the waveform record that is being viewed relative to the current acquisition total record length.



If cursors are active on a waveform, the Waveform Record View shows the relative cursor positions as small vertical dashed lines.



When in Zoom mode, the Waveform Record View is replaced with the Zoom Overview. See [Zoom user interface elements](#) on page 51.

2. The Expansion Point icon on the waveform view shows the center point around which the waveform expands and compresses when changing horizontal settings.



3. The Trigger Position Indicator shows where the trigger event occurred in the waveform record.



4. The Zoom icon (in upper right corner of Waveform and Plot views) toggles zoom on and off.



5. The Trigger Level Indicator icon(s) shows the trigger level(s) on the trigger source waveform. Some trigger types require two trigger levels.
6. Measurement and Search badges show measurement and search results. See [Badges](#) on page 44. See [Add a measurement](#) on page 77.
7. The Results Bar Handle opens or closes the **Results bar** to maximize waveform screen viewing when needed. To reopen the **Results bar**, either tap the handle icon or swipe left from the right side of the display.
8. The System badges show global instrument settings (**Horizontal**, **Trigger**, **Acquisition**, Run/Stop status, and Date/Time). See [Badges](#) on page 44.
9. The Inactive Channel buttons add channel waveforms to the Waveform view and add an associated Channel badge to the Settings bar.

The **Add Math Ref Bus** button expands allowing you to add a math, reference, or bus waveform to the Waveform view and add an associated Waveform badge to the **Settings** bar.

The **RF** button activates the frequency domain display and adds an RF badge. Double-tap the badge to open the RF configuration menu to configure the RF input. This button is only active if one of the RF options is enabled.

The **AFG** button opens the AFG configuration menu to set and enable the AFG output. This button is only present if the AFG option is installed.

The **DVM** button lets you use an analog probe to take DC, AC RMS, or DC +AC RMS voltage measurements on your DUT. Tap the button to add a DVM badge to the Results Bar and open a configuration menu. The DVM option also enables a trigger frequency counter, accessible from the **Mode & Holdoff** panel in the **Trigger** badge menu. This button is only present if the DVM option is installed.

10. Double-tap a badge to open its associated configuration menu. See [Badges](#) on page 44. See [Configuration menus](#) on page 50.

If you add more Channel or Waveform badges than can fit in the waveform badge display area, tap the scroll buttons at each end of the waveform badge area to scroll and display hidden badges.

11. The Waveform Handles on each waveform identify the source of that waveform (Cx for channels, M for Math, Rx for Reference waveforms, Bx for bus waveforms). The waveform handles are at the zero-volt level of the waveform by default. The currently selected waveform handle is a solid color; unselected waveform handles are outlined.

Double-tapping a waveform handle opens the configuration menu for that waveform.

For digital channels, the waveform handle shows the channel number, with each individual digital signal labeled D0–D15 and displayed with a different color.



Double-tapping a digital waveform handle opens the digital channel configuration menu.

Dragging a digital signal handle over another handle swaps location of the signals in the waveform view. Dragging a digital signal handle out of the group, creates a new group. A selected digital group or signal handle can be moved using the Vertical Position control.

Identifying items in the frequency domain display

This topic shows and describes each element of the frequency domain display.

To activate the frequency domain display, press the front panel RF button or tap the RF button in the display .

Each area of the user interface has a specific function that helps manage information or controls.

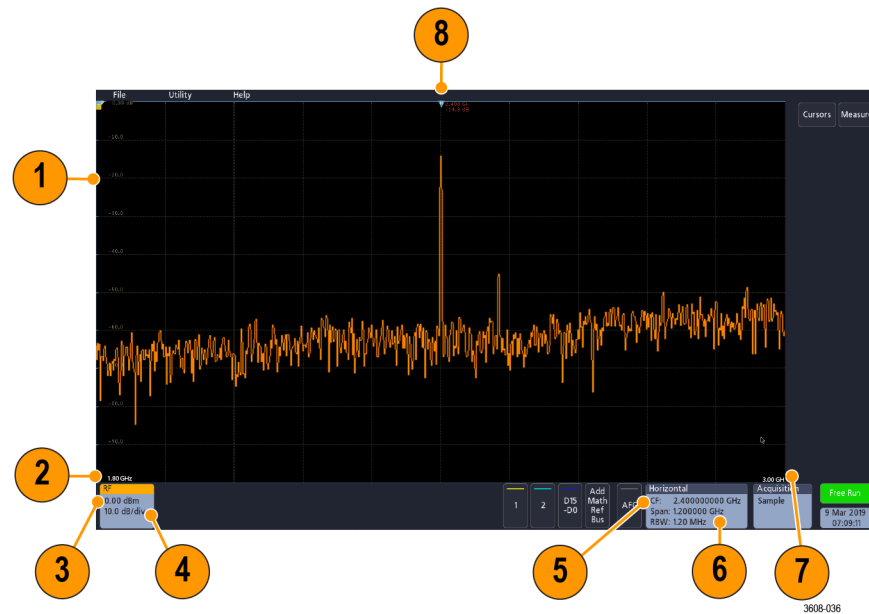

1. Vertical graticule labels
2. Start frequency
3. Reference level
4. Vertical scale
5. Center frequency
6. Span and resolution bandwidth
7. Stop frequency
8. Reference marker

9. Displayed trace indicators

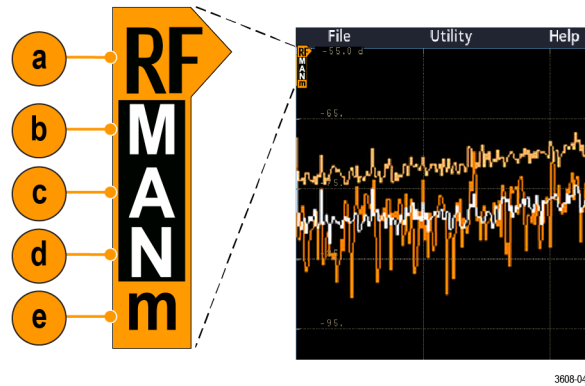

- a. An RF trace indicator is placed at the Reference Level.
- b. A capital M appears if the maximum trace is turned on.
- c. A capital A appears if the average trace is turned on.
- d. A capital N appears if the normal trace is turned on.
- e. The small m appears if the minimum trace is turned on.

Orange highlighting indicates the currently selected trace. In the figures the small m, which stands for the minimum trace, is highlighted. This indicates that the minimum trace is currently selected.

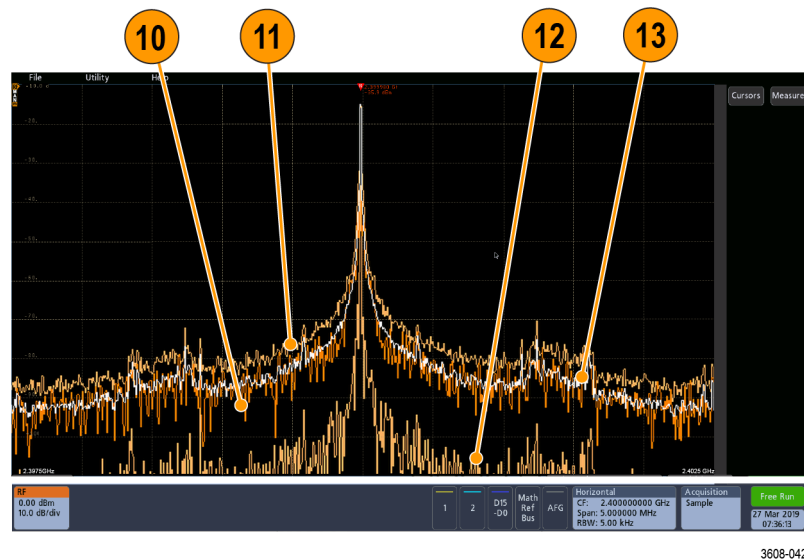

- 10. Normal trace: Each acquisition is discarded as new data is acquired.
- 11. Max hold trace: The maximum data values are accumulated over multiple acquisitions of the Normal trace.
- 12. Min hold trace: The minimum data values are accumulated over multiple acquisitions of the Normal trace.
- 13. Average trace: Data from the Normal trace is averaged over multiple acquisitions. This is true power averaging, which occurs before the log conversion. Each power of 2 averaging reduces the displayed noise by 3 dB.

Identifying items in the arbitrary function generator display

This topic shows and describes each element of the arbitrary function generator display.

Each element of the arbitrary function generator display gives information about the generated function.

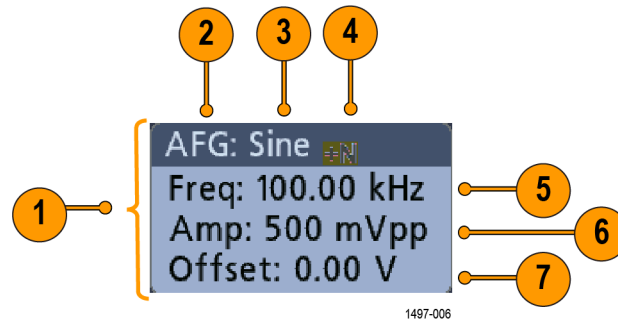

1. If visible, the output is on
2. AFG label
3. Waveform type, such as Sine
4. Additive Noise icon
5. Frequency
6. Amplitude
7. Offset

Identifying items in the digital voltmeter display

This topic shows and describes each element of the digital voltmeter display.

Each element of the digital voltmeter display gives information about the measurement.

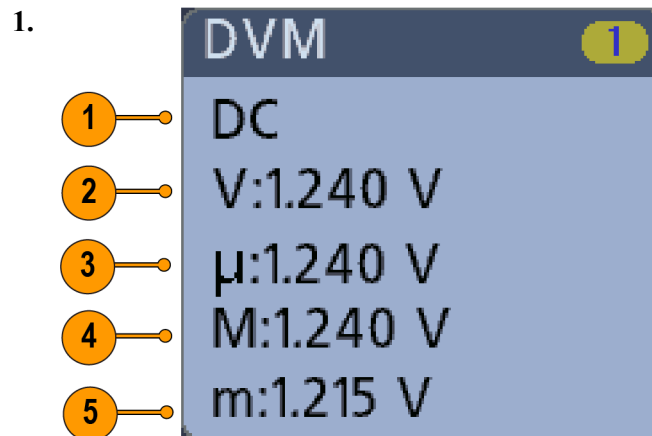

1. Measurement type (AC+DC RMS, DC, AC RMS, or Frequency)
2. Numerical value of the current measurement

3. Average of all measurement values recorded since you powered on the instrument or since you last reset DVM statistics.
4. Maximum measurement value recorded since you powered on the instrument or since you last reset DVM statistics.
5. Minimum measurement value recorded since you powered on the instrument or since you last reset DVM statistics.

Badges

Badges are rectangular icons that show waveform, measurement, and instrument settings or readouts. Badges also provide fast access to configuration menus. The badge types are Channel, Waveform, Measurement, Search, and System.

Channel and Waveform badges

Channel and Waveform (**Math, Ref, Bus**) badges are shown in the **Settings Bar**, located along the bottom left of the screen. Each waveform has its own badge. The badges show high-level settings for each displayed channel or waveform. Double-tap a badge to open its configuration menu.

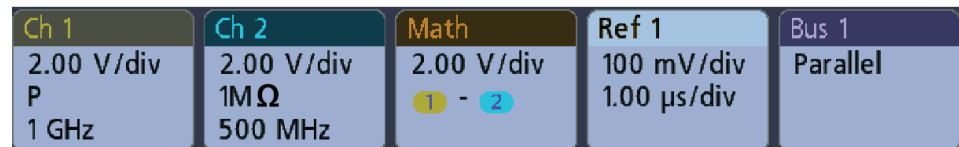

1497-013

Most Channel and Waveform badges also have Vertical Scale buttons, shown by single-tapping the badge. Use these buttons to increase or decrease the vertical scale setting for that waveform.



You can drag or flick Channel and Waveform badges down off the display to turn them off. Swiping back up from the bottom of the display restores them if they were accidentally deleted.

Channel badges are listed in the channel order. For more information, double-tap the badge to open its configuration menu or search the instrument Help.

Measurement badges

Result badges are located in the **Results** Bar. They show measurement or search results. The badge title also shows the measurement source or sources. To add a Measurement badge, tap the **Measure** button, select a measurement, and tap **Add**.

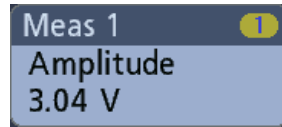

Double-tap a Measurement badge to open its configuration menu to change or refine settings.

Some measurements and their badges are only available as options. For example, Power measurements are only listed in the Add Measurement menu if the PWR option is installed.

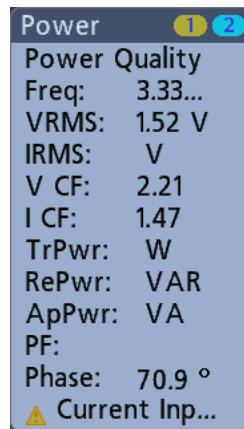

To add statistical readouts to individual measurement badges, double-tap a measurement badge to open its configuration menu and select **Show Statistics in Badge**.

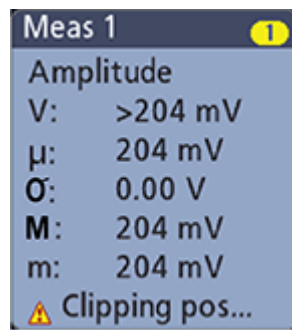

You can drag or flick Measurement badges off to the right of the display to delete them. You can bring the badge back by swiping in from the right.

Search badges

Search badges are also shown in the Results Bar, below the Measurement badges. A search badge lists the search source, search type, and the number of search event occurrences in the current acquisition. The instrument marks the waveform where those events occur with small down-pointing triangles along the top of the waveform graticule. Double-tap a search badge to open its configuration menu to change or refine search settings.

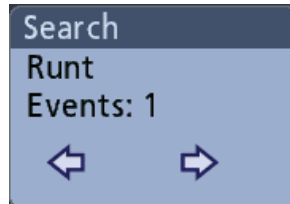

Search badges are created by tapping the **Search** button. Use the displayed configuration menu to set the search criteria.

Search badges have < (Previous) and > (Next) Navigation buttons that open the Zoom mode and center the waveform in the display at the position of the previous or next search mark in the waveform record. Search badge Navigation buttons are only usable when acquisitions are stopped.

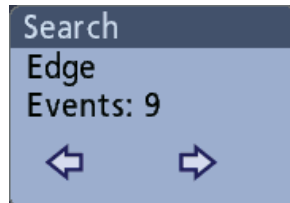

You can drag or flick a Search badge to the right, off the display, to delete it. You can bring the badge back by swiping in from the right.

Signal clipping and badges

Clipping causes inaccurate amplitude-related measurement results. Clipping also causes inaccurate amplitude values in saved waveform files. If a math waveform is clipped, it will not affect amplitude measurements on that math waveform.



WARNING. Clipping is caused by excessive or dangerous voltages at the probe tip and/or a vertical scale setting that is not adequate to display the entire vertical range of the waveform. Excessive voltage at the probe tip can injure the operator and cause damage to the probe and/or instrument.

This instrument shows a warning triangle symbol and the word *Clipping* in a Channel badge when a vertical clipping condition exists. Any measurement badges associated with that channel also indicate a clipping condition.

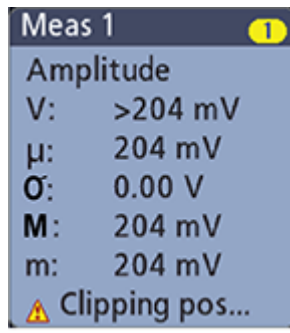

To close the clipping message, change the vertical scale to show the entire waveform, disconnect the probe tip from the excessive voltage source, and check that you are probing the correct signal using the correct probe.

Error messages and badges

This instrument shows a warning triangle symbol and an error message abbreviation in a Channel badge when an error occurs.



To remove the message from the badge, clear the error.

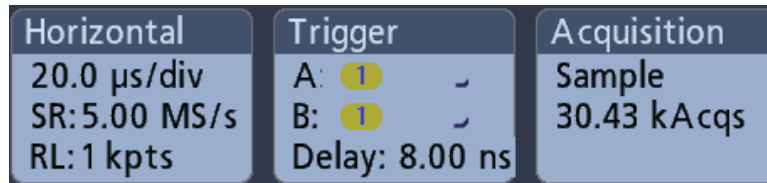

System badges System badges (in the **Settings** bar) display the main Horizontal, Trigger, and Acquisition settings. You cannot delete System badges.



Double-tap a System badge to open its configuration menu.

The Horizontal badge also has Scale buttons, shown by single-tapping the badge. Use the Horizontal Scale buttons to increase or decrease the horizontal time/div setting.

Common badge actions

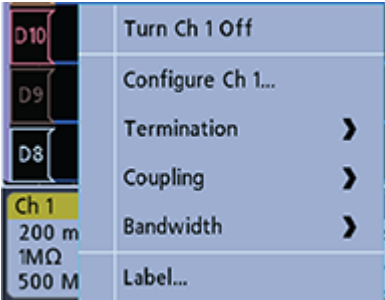
Action	Result	Example
Single tap	Immediate access controls (Scale, Navigation).	
Double tap	Configuration menu with access to all settings for the badge.	
Touch and hold	Right-click menu with single tap access to common actions. Typical actions include turning off a channel and deleting a measurement or search badge.	

Configuration menus

Configuration menus let you quickly set the parameters for channels, system settings (Horizontal, Trigger, Acquisition), measurements, cursor readouts, Waveform view, and so on.

Double-tap an item (badge, **Waveform View**, cursor readouts, and so on) to open its configuration menu. For example, double-tap a Channel badge in the **Settings Bar** to open its configuration menu.

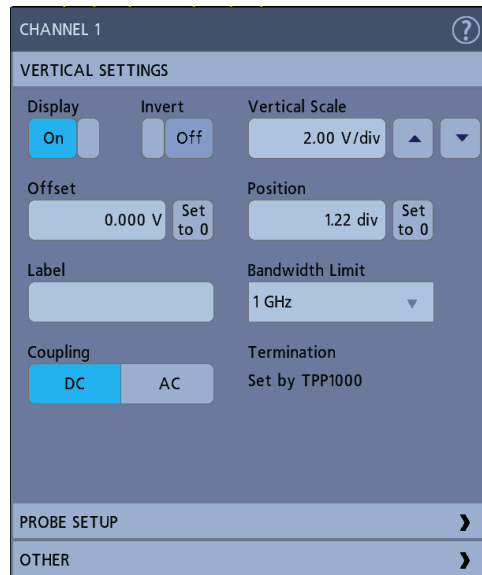

Selections or values that you enter take effect immediately. Menu contents are dynamic and can change depending on your selections, instrument options, or attached probes.

Related settings are grouped into 'panels.' Tap the panel name to show those settings. Changes to panel settings can change the values and/or fields shown in that panel and other panels.

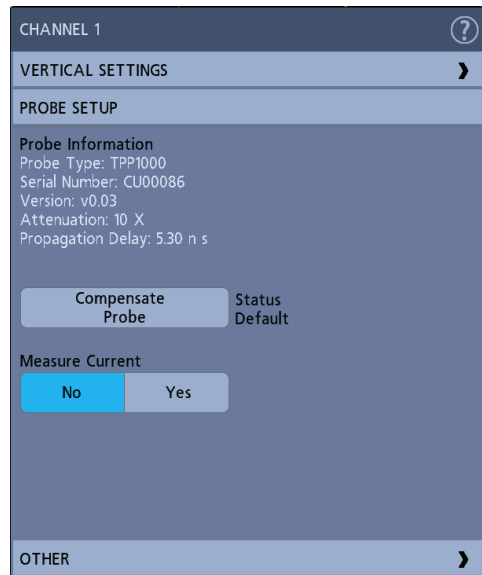

Tap anywhere outside a configuration menu to close it.

To open Help content for a configuration menu, tap the question mark icon in the upper right corner of the menu.

Zoom user interface elements

Use the zoom tools to magnify waveforms to view signal details.

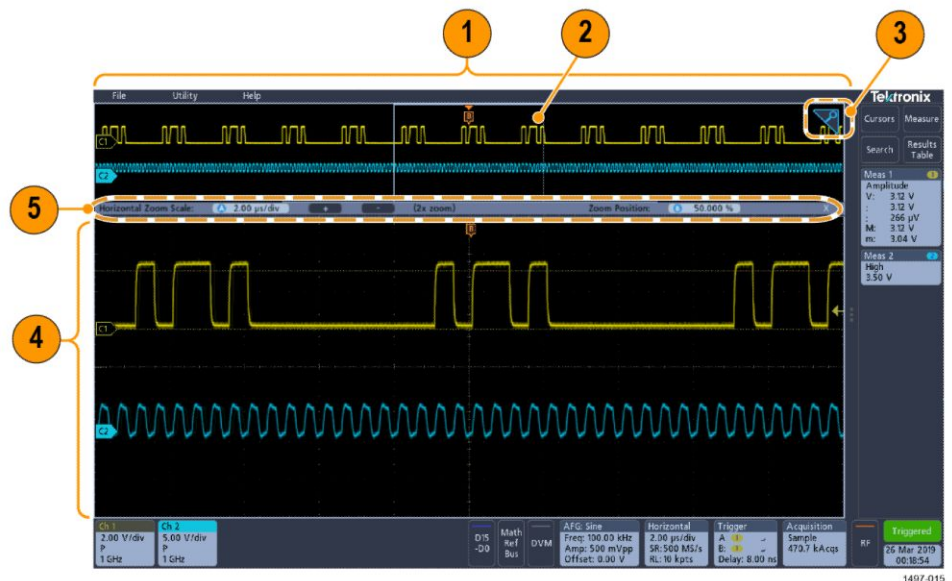

1. The **Zoom Overview** shows the entire waveform record.

NOTE. Using pinch and expand gestures on the Zoom Overview waveforms changes the horizontal time base settings.

2. The **Zoom Box** shows the area of the Zoom Overview to display in the Zoom View (see 4). You can touch and drag the box to move the area to view.

NOTE. Moving the Zoom Box or changing its position does not change the horizontal time base settings.

3. The **Zoom** icon (in the upper right corner of the Waveform View) switches zoom mode on and off.

4. The **Zoom View** shows the zoomed waveforms as marked by the Zoom Box. Use pinch and/or drag options in the zoom view to change the zoomed area of interest.

NOTE. Pinch, expand, and drag gestures in the Zoom View only change zoom magnification settings and Zoom Box position.

5. Use the **Zoom Title Bar** controls to adjust the horizontal size and the position of the zoom area. Click or tap the + or - buttons or use the A and B multipurpose knobs. Double tap the zoom scale and position fields to enter a value using a numerical keypad.

NOTE. Touch the **Zoom Position** or **Horizontal Zoom Scale** fields before using the multipurpose knobs to adjust the zoom.

Using the touchscreen interface for common tasks

Use standard touchscreen actions, similar to those found on smart phones and tablets, to interact with most screen objects. You can also use a mouse to interact with the UI. The equivalent mouse operation is shown for each touch operation.

See the table to quickly learn the fundamental touch operations.

Table 14: Common touchscreen UI tasks (with mouse equivalents)

Task	Touchscreen UI action	Mouse action
Add a channel, math, reference, or bus waveform to the screen.	Tap an inactive channel button or the Add Math Ref Bus button and select a math, reference, or bus.	Click an inactive channel button or the Add Math Ref Bus button and select a math, reference, or bus.
Select a channel, math, reference, or bus waveform to make it active.	Tap the Channel or Waveform badge or waveform handle.	Click the Channel or Waveform badge or waveform handle.
Display scale or navigation buttons on a badge (waveform, measurement ¹ , search, horizontal).	Tap the badge.	Click the badge.
Open a configuration menu on any item (all badges, views, cursor readouts, labels, and so on).	Double-tap the badge, view, or other object.	Double-click the badge, view, or other object.
Open a right-click menu (badges, views).	Touch and hold on the badge, Waveform View, or other screen item until a menu opens.	Right-click the object.
Close a configuration menu ² .	Tap anywhere outside the menu or dialog.	Click anywhere outside the menu or dialog.
Move a menu.	Touch and hold the menu title bar or a blank area in the menu, then drag the menu to new position.	Click and hold the left mouse button on title or blank area and then drag to new position.
Change horizontal or vertical settings directly on a waveform. Vertical changes only apply to the selected channel or waveform; horizontal changes apply to all channels and waveforms.	Tap a badge and use the Scale buttons. Or, use pinch/expand gestures.	Click a channel, waveform, or Horizontal badge and click on the Scale buttons.

¹ Not all measurement or search badges display navigation buttons.

² Some dialog boxes will not close until you click an OK, Close, or other button in the dialog.

Task	Touchscreen UI action	Mouse action
Increase or decrease the zoom area (while in Zoom mode).	Touch and hold two fingertips on the waveform view, move them together or apart vertically or horizontally, lift from screen, and repeat.	Click and drag the zoom area. Click the + or - buttons on the Zoom Title bar.
Adjust the zoom position (while in Zoom mode).	Touch and drag in the zoom area to adjust the position of the zoom.	Click and drag in the zoom area to adjust the position of the zoom.
Quickly scroll or pan a waveform.	Touch and drag in the waveform.	Click and drag in the waveform or list.
Close or open the Results Bar to increase the Waveform View area.	Tap on the Results Bar Handle or anywhere in the border between the Waveform View and the Results Bar .	Click the Results Bar Handle or anywhere in the border between the Waveform View and the Results Bar . Click and drag the Results Bar divider.

Accessing application help

Use the instrument online help to quickly get information about a function or assistance in performing a task.

Using context-sensitive help

To open help on a particular menu or item, tap the Help button (question mark symbol) in the title bar. The browser opens with content relevant to the menu or item.

Navigating the online help

Select **Help > Help** to display the help browser is similar to PC-based Help tools. From the help browser, select one of the following tabs:

- **Contents.** Click any entry to display information on the subject.
- **Index.** Click an entry to display information on the subject.

Configure the instrument

Set the date and time

Set the date and time so that saved files are marked with the correct date and time information.

1. Double-tap the **Date/Time** badge (bottom-right of screen) to open the configuration menu.

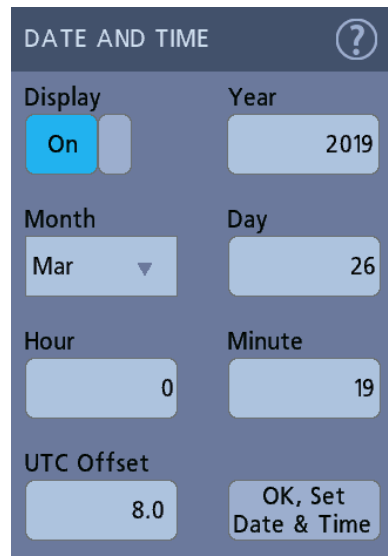

2. To turn off showing the date and time on the screen, tap the **Display** button to **Off**.
To turn on date/time display again, double-tap in the blank area where the date/time badge was displayed to open the configuration menu and set the **Display** button to **On**.
3. You may also tap the **Year**, **Day**, **Hour**, **Minute**, or **UTC Offset** fields and use the multipurpose knobs to set the fields to the correct time.
You may also double-tap the fields and use the numeric keypad to set the time.
4. Tap **Month** and select the month from the list.
5. Tap anywhere outside of the menu to close it.

Functional check

Use this procedure to quickly verify that the oscilloscope can display a waveform and take a measurement.

1. Power on the oscilloscope.
2. Tap **Utility** > **Self test**. Check that all tests listed show **Pass**.
3. Connect an analog probe to the Channel 1 connector.
4. Connect the probe tip and ground lead to the probe compensation connectors.
5. Push the **Autoset** button. You should see a square wave in the display (approximately 2.5 V_{P-P}).
6. Tap the **Measure** button.
7. Tap the **Time Measurements** panel in the Add Measurements configuration menu.
8. Double-tap the **Frequency** button and then the **Add** button to add the frequency measurement to the Results bar.
9. Check that the **Frequency** measurement reads 1 kHz
10. Repeat these steps to check the other channels on the oscilloscope. Make sure that you set the source in the Add Measurement configuration menu to use the correct channel before adding the Frequency measurement.

Download and install the latest firmware

Installing the latest firmware helps ensure that your instrument is equipped with all of the best available measurement and analysis improvements.

Prerequisite: Save any important on-instrument files (waveforms, screen captures, oscilloscope setups, and so on) to a USB drive or network. The installation process does not remove user-created files, but it is a good idea to back up important files before an update.

Update oscilloscope firmware from a USB drive

Prerequisite: Determine the current version of firmware installed on the oscilloscope (**Help** > **About**)

1. Open up a Web browser on a PC and go to www.tek.com/product-support.
2. Enter the oscilloscope model number in the search field and click **Go**.
3. Scroll down the screen and click the **Software** tab.
4. If the listed available firmware version is newer than what is on your oscilloscope, select and download that file to your PC.
5. Copy the firmware install file to a USB drive.

6. Insert the USB drive into any oscilloscope USB Host port:
7. Power off the oscilloscope and then power on the oscilloscope.

NOTE. Do not power off the oscilloscope or remove the USB flash drive until the oscilloscope finishes installing the firmware. The oscilloscope displays a message when it is OK to turn off the oscilloscope.

The oscilloscope detects the USB drive with the firmware file and starts the installation process. Follow on-screen instructions to install the firmware.

8. When the firmware install is finished, remove the USB drive and restart the oscilloscope.
To confirm the firmware installation:
 - a. Tap **Help > About** in the Menu bar.
 - b. Verify that the firmware version number listed on the screen is the same version that you downloaded.

Run Signal Path Compensation (SPC)

Run SPC at regular intervals for best measurement accuracy. You should run SPC whenever the ambient (room) temperature has changed by more than 5 °C (9 °F) or once a week if you use vertical scale settings of 5 mV/div or less.

Signal Path Compensation (SPC) corrects for DC level inaccuracies in the internal signal path caused by temperature variations and/or long-term signal path drift. Failure to run SPC on a regular basis may result in the oscilloscope not meeting warranted performance levels at low volts per division settings.

Prerequisite: Disconnect all probes and cables from the front-panel channel inputs and rear-panel signal connectors.

1. Power on and warm up the oscilloscope for at least 20 minutes.
2. Tap **Utility > Calibration**.
3. Tap **Run SPC**. The **SPC Status** readout shows **Running** while SPC is running. SPC can take several minutes per channel to run, so wait until the SPC Status message changes to Pass before reconnecting probes and using the oscilloscope.
4. Close the **Calibration** configuration dialog when SPC has completed.
5. If SPC fails, write down any error message text. Make sure that all probes and cables are disconnected and run SPC again. If SPC still fails, contact Tektronix Customer Support.

Compensate TPP0250, TPP0500B, or TPP1000 probes

Probe compensation adjusts the high frequency response of a probe for best waveform capture and measurement accuracy. The oscilloscope can automatically test and store compensation values for TPP0250, TPP0500B and TPP1000 probes.

The oscilloscope stores the compensation values for each probe/channel combination and automatically recalls the compensation values when you plug in the probe again. Probe compensation status is shown in the Probe Setup panel of the Channel configuration menu.

- If the Probe Compensation Status field displays **Pass**, the probe is compensated and ready for use.
- If the Probe Compensation Status field displays **Default**, the attached probe has not been compensated and needs to have this probe compensation procedure run.
- If the Probe Compensation Status field displays **Fail**, the attached probe has failed the probe compensation procedure. Reconnect the probe and run probe compensation again.
- If there is no probe compensation status field shown in the panel, the oscilloscope cannot store compensation values for that probe. See the oscilloscope Help for how to manually compensate passive probes not supported by the probe compensation function.
- Each compensation generates values for a specific probe and channel combination. If you want to use the probe on another channel and desire to compensate the new probe-channel pair, you must run a new set of compensation steps.
- Each channel can store compensation values for 10 individual probes. If you try to compensate an 11th probe on a channel, the oscilloscope will delete the values for the least recently used probe and add the values for the new probe.

Use this procedure to compensate a TPP0250, TPP0500B, TPP1000, or other supported TPP-family probe that shows a **Default** status when connected to the oscilloscope.

NOTE. A **Default Setup** does not delete probe compensation values. A factory calibration deletes all stored probe compensation values.

Prerequisite: The oscilloscope must be powered on for at least 20 minutes before compensating a probe.

1. Connect a supported probe to an input channel.
2. Connect the probe tip and ground lead of the probe to the PROBE COMP terminals on the lower right of the oscilloscope (see following image).

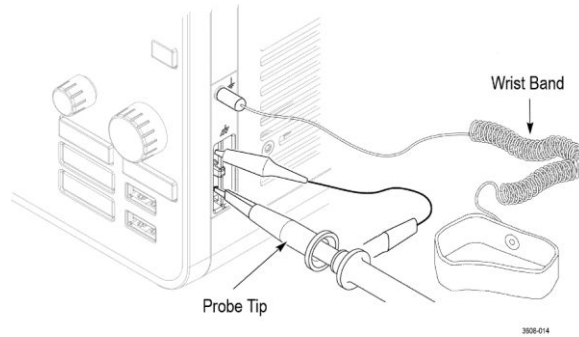

Figure 4: Probe Comp connections.

Connect the probe tip to the 1 kHz source and the ground clip to the ground. For best results, remove any probe tip accessories and hold the probe tip directly onto the 1 kHz connector.

NOTE. Connect only one probe at a time to the PROBE COMP terminals.

3. Turn off all channels.
4. Turn on the channel to which the probe is connected.
5. Push the front-panel **Autoset** button. The screen displays a square wave.
6. Double-tap the badge of the channel that you want to compensate.
7. Tap the **Probe Setup** panel.

If the Probe Compensation Status says **Pass**, the probe is already compensated for this channel. You can move the probe to another channel and start again from step 1 or connect a different probe to this channel and start from step 1.

If the Probe Compensation Status says **Default**, continue with this procedure.

8. Tap **Compensate Probe** to open the **Probe Compensation** dialog.
9. Tap **Compensate Probe** to run the probe compensation.
10. The probe compensation is finished when the Probe Compensation Status displays **Pass**. Disconnect the probe tip and ground from the PROBE COMP terminals.
11. Repeat these steps for each supported passive probe that you want to compensate for this channel.

12. Repeat these steps to compensate supported probes on other channels of the oscilloscope.

NOTE. For most accurate measurements, open the **Probe Setup** panel and verify the Probe Compensation Status is **Pass** whenever you attach a probe to a channel.

NOTE. A probe compensation failure is most likely due to intermittent connection of the probe tip or ground connection during the probe compensation operation. If a failure occurs, the oscilloscope will re-use the old probe compensation values if they existed prior to the failed probe compensation operation.

Compensate passive probes

Probe compensation adjusts the high frequency response of a probe for best waveform capture and measurement accuracy. Use this procedure to adjust probe compensation for probes with a manual adjustment.

A passive probe is only adjusted for one channel at a time. If you move a passive probe to another channel, you must compensate that probe to that channel.

1. Connect the probe to the channel where you want to use it to take measurements. Remove all other probes.
2. Turn on the channel to which the probe is connected. Turn off all other channels.
3. Attach the probe tip and reference lead to the probe compensation connectors.
4. Push the **Autoset** button to display a square wave.
5. Adjust the vertical **Scale** and **Position** knobs to display as large a waveform as possible.
6. Use the adjustment tool provided with the probe to adjust the probe until the square wave has as flat a top as possible. See your probe manual for adjustment location and instructions.



Connect to a network (LAN)

Connecting to a network allows you to remotely access the instrument.

Work with your network administrator to obtain the required information to connect to your network (IP address, Gateway IP address, Subnet Mask, DNS IP address, and so on).

1. Connect a CAT5 cable from the oscilloscope LAN connector to your network.
2. Select **Utility > I/O** on the menu bar to open the I/O configuration menu.
3. Tap the **LAN** panel
4. Obtain or enter the network address information:
 - If your network is DHCP-enabled and the IP address field does not already show an address, tap **Auto** to obtain the IP address information from the network. DHCP mode is the default mode.
 - If your network is not DHCP-enabled or you need a static (non-changing) IP address for this instrument, tap **Manual** and enter the IP address and other values provided by your IT or system administrator resource.
5. Tap **Test Connection** to verify that the network connection is working. The LAN Status icon turns green when the instrument successfully connects to your network. If you have problems connecting to your network, contact your system administration resource for help.

Mount a network drive

Use this procedure to mount (map) a network Linux mount point or Windows shared directory on a standard instrument.

Prerequisites:

The oscilloscope must be connected to a network that has access to the directories to mount or unmount. See the *Connect to a network (LAN)* topic in the application Help.

To mount a Linux network drive on the oscilloscope, the network Linux mount point (drive, host) that you want to mount must be exported. If the mount point is not exported, work with your organization's IT resource to get that location exported and accessible to your network.

To mount a network drive on your oscilloscope:

1. Tap **File > File Utilities**.
2. Tap **Mount** to open the **Mount Network Drive** menu.
3. Select the drive letter to assign to the network drive from the **Drive Letter** list.
4. Tap **Name** or **IP** to specify how you will enter the host name (server) of the network mount location or PC.

5. Enter the network host name or IP address of the Linux mount point or server in the **Server Name** or **Server IP Address** field. Example: ACME-PC0205
6. Enter the path to the location of the mount point or shared directory of the server in the **Path** field.
 - Linux example: /opt/testing/batch1 (Linux requires forward slashes in path definitions. Linux assumes that the path starts at the root directory.)
7. If access to this network location is controlled, enter the required information in the **User Name** and **Password** fields.
8. Tap **Enter**. The oscilloscope mounts the drive and adds the specified drive letter to the **File Utilities** menu.

The oscilloscope displays an error message if it cannot mount the drive. Work with your organization's IT resource to verify that the access information is correct and to resolve the network access problems.

Unmount a network drive

Use this procedure to unmount (remove) a network Linux mount point or Windows shared directory from a standard or Windows OS instrument.

To unmount a network drive from your instrument:

1. Tap **File > File Utilities**.
2. Select the drive to unmount.
3. Tap **Unmount**. The instrument unmounts the drive and removes it from the Drive column.

NOTE. Any network locations that were mounted when the oscilloscope was powered down will be automatically remounted when the oscilloscope is powered up. Unmount any network location that you do not want to automatically remount on power up.

Deskew analog input channels - quick visual method

Use the following procedure to visually align waveform edges to compensate for timing differences between probes.

Critical timing measurements on multiple channels require that all probes be adjusted, or deskewed, to compensate for signal timing differences between probes. This procedure uses displayed waveform edges to quickly minimize deskew between probes.

NOTE. *Once probes have been deskewed for a particular channel, you should only use the probes on the channels for which they were deskewed, when taking critical timing measurements.*

1. Connect all probes that you want to deskew.
2. Connect up to four probe tips and ground leads to the Probe Compensation connector (maximum of four channels at a time).
3. Turn on (display on screen) the connected channels that you want to deskew.
4. Push the **Autoset** button.
5. Adjust the vertical **Scale** and **Position** controls for each channel so that the signals overlap and are centered on the display.
6. Adjust the horizontal **Scale** so that the differences in the channel delays are clearly visible.
7. Determine the channel you want to use as your reference.
8. Double-tap the Channel badge of a channel other than the reference channel and tap the **Other** panel.
9. Tap the **Deskew** field and use the multipurpose knob to align this channel with the reference channel waveform such that the waveforms cross the trigger point at the same time. For fine adjust, double-tap the **Deskew** field to open a number pad.
10. Repeat steps 8 and 9 for each additional channel you want to deskew.

Deskew analog input channels - measurement method

Use the following procedure to more accurately minimize timing differences between probes.

Critical timing measurements on multiple channels require that all probes be adjusted, or deskewed, to compensate for signal timing differences between probes. This procedure uses a Delay measurement to adjust a probe's deskew setting.

NOTE. *Once probes have been deskewed for a particular channel, you should only use the probes on the channels for which they were deskewed when taking critical timing measurements.*

1. Connect all probes that you want to deskew to the oscilloscope.
2. Connect up to four probe tips and ground leads to the Probe Compensation connector.
3. Turn on all the channels that you want to deskew.
4. Push the **Autoset** button.
5. Change the vertical Scale of all active channels to **500 mV/div** and adjust the vertical Position so that the waveforms are centered on the display.
6. Determine the channel you want to use as your reference.
7. Tap the **Measure** button and tap the **Time Measurements** panel.
8. Select the **Delay** measurement, then tap the **Add** button.
9. Double-tap the **Delay** measurement badge and set your chosen reference channel as **Source 1** and your channel being deskewed as **Source 2**.
10. Double-tap the Channel badge of the channel being deskewed (Source 2) and tap the **Other** panel
11. Tap the **Deskew** field and use the multipurpose knob to align this channel with the reference waveform such that the measured delay between channels becomes a minimum. For fine adjust, double-tap the **Deskew** field to open a number pad.
12. Double-tap the **Delay** measurement badge and set the Source 2 channel to the next channel to deskew.
13. Repeat steps 10 through 12 for each additional channel you want to deskew.

Connect a keyboard or mouse

The instrument supports most standard USB-connected keyboards and mice, including wireless-connected keyboards and mice (using a USB-connected dongle).

You can use the keyboard to quickly create names or labels. Use the arrow keys on the keyboard to move the insertion point, and then type in a name or label. Labeling channels and buses makes the information on the screen easier to identify. Connect a keyboard and/or mouse by connecting their USB cable, or USB dongle, into any available USB Host port. The keyboard or mouse should work immediately. If it does not, try the following:

1. Remove and reinsert the USB cable or dongle in the same port.
2. Insert the USB cable or dongle into a different USB port.

Connect an external monitor or projector

Use the video outputs to send the instrument display to a projector or to a flat-panel LCD monitor.

1. Power on the oscilloscope.
2. Connect the appropriate video cable to the projector or monitor. Connect the other end to the HDMI connector on the oscilloscope.
3. Power on the projector or monitor.
4. Follow the projector or monitor instructions to set up and adjust the image.

ESD prevention guidelines

Electrostatic discharge (ESD) can damage oscilloscope and some probe inputs. This topic discusses how to avoid this type of damage.

ESD is a concern when handling any electronic equipment. The instrument is designed with robust ESD protection, however it is still possible that large discharges of static electricity directly into the signal input may damage the instrument. Use the following techniques to prevent electrostatic discharge from damaging the instrument.

- Discharge the static voltage from your body by wearing a grounded antistatic wrist strap while connecting and disconnecting cables, probes, and adapters. The instrument provides a ground connection for attaching a wrist strap (above the Probe Comp ground connector).
- A cable that is left unconnected on a bench can develop a large static charge. Discharge the static voltage from all cables before connecting them to the instrument or device under test by momentarily grounding the center conductor of the cable, or by connecting a 50 Ω termination to one end, before attaching the cable to the instrument.

- Before you apply power, connect the instrument to an electrically-neutral reference point, such as earth ground. To do this, plug the three-pronged power cord into an outlet grounded to earth ground. Grounding the oscilloscope is necessary to ensure safety and to take accurate measurements.
- If you are working with static sensitive components, ground yourself. Static electricity that builds up on your body can damage static-sensitive components. Wear a wrist strap to safely send static charges on your body to earth ground.
- The oscilloscope must share the same ground as any circuits that you plan to test.

Analog channel operating basics

Acquiring a signal

After acquiring a signal you can take measurements.

Use the following procedure to set the scale and position parameters for analog signal acquisition.

1. Press the Default Setup button.
2. Connect the probe output to the desired oscilloscope channel and connect the probe input to the input signal source using proper probing/connecting techniques.

NOTE. *Some probes automatically set their termination and other values.*

3. Tap the channel button to add the channel waveform to the waveform view and add a channel badge to the setting bar. A channel button lights when its channel is on.
4. Double-tap the channel badge to open the channel Vertical Settings menu. To change the input coupling, select the appropriate coupling button.
 - Select DC to couple both the AC and DC components of an input signal.
 - Select AC to couple only the AC components of an input signal.
5. Use the Vertical knobs to scale and position the waveform vertically on the screen. The knobs are highlighted with the color of the active channel. Dragging the waveform handle also positions the waveform.
6. Use the Vertical Settings menu to change the offset. Tap Offset, then use a multipurpose knob to adjust the offset.
7. Use the Horizontal knobs to scale and position the waveform horizontally on the screen and to set the record length. Dragging the trigger position icon or the waveform itself also positions the waveform.
8. Use the Horizontal menu to set the record length.
9. You may attempt to stabilize the display by pressing the trigger Level knob to set the trigger level to 50%. The 50% level is calculated as the midpoint between the highest and lowest samples of the acquired waveform. If your signal is periodic, you should see a stable, triggered signal. This method will not work as well with random signals.

Quickly display a waveform (autoset)

The Autoset function analyzes the signal characteristics and changes the instrument's Horizontal, Vertical, and Trigger settings to automatically display a triggered waveform. You can then make further changes to trigger and horizontal settings to view the points of interest.

1. Connect the probe with the signal of interest to an available channel. The signal can be analog or digital.
2. Double-tap the **Trigger** badge and set the trigger source to that of the signal of interest.
3. Connect any other associated signal(s) to available channel input(s).
4. Add the channel waveforms to the Waveform view. See [Add a channel waveform to the display](#) on page 73.
5. Tap **File > Autoset** or push the front-panel **Autoset** button. The instrument analyzes the signal characteristics of the trigger source channel (analog or digital) and adjusts the horizontal, vertical, and trigger settings accordingly to display a triggered waveform for that channel.

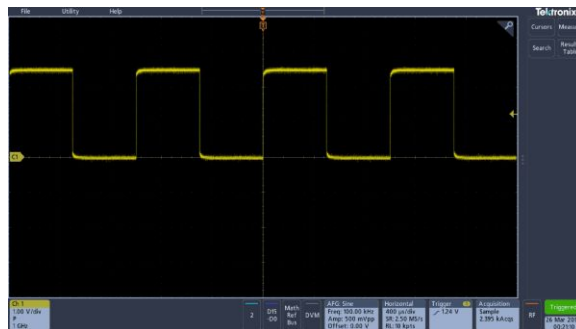

Autoset guidelines:

- Autoset displays four or five cycles (depending on the detected signal) with the trigger level near the midlevel of the signal.
- The trigger is set to type Edge, rising slope, DC coupling.
- If no channels are displayed before pushing **Autoset**, the oscilloscope adds Ch 1 to the Waveform view whether it has a signal or not.
- Autoset ignores math, reference, and bus waveforms.
- A channel or waveform with a frequency less than 40 Hz is classified as no signal.

Set horizontal parameters

Use this procedure to set the horizontal time base parameters such as position, horizontal scale, and delay.

1. Double-tap the **Horizontal** badge on the Settings bar to open the Horizontal configuration menu.

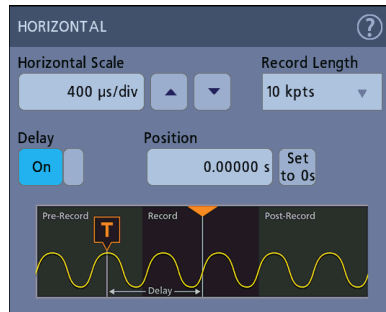

2. Use the menu selections to set horizontal parameters.
3. Tap the Help icon on the menu title for more information on these settings.

How to trigger on a signal

Use this procedure to open the Trigger menu to select and configure the trigger event type and conditions.

1. Double-tap the **Trigger** badge on the Settings bar to open the Trigger configuration menu.
2. Select a trigger from the **Trigger Type** list. The trigger type sets what fields are available in the menu and also updates the illustration to show a graphic of the trigger type.

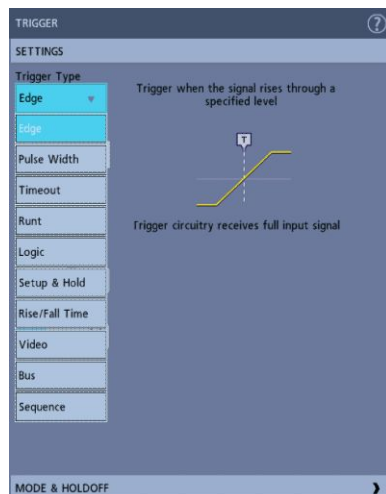

NOTE. To trigger on a bus, you must first add the bus to the Waveform view. See [Add a math, reference, or bus waveform](#) on page 75

NOTE. Triggering on buses other than Parallel requires the purchase and installation of serial trigger and analysis options. See the Tektronix Web site for available serial trigger and analysis options.

3. Select the other fields to refine the trigger conditions. The menu fields and trigger graphic update as you make changes to the trigger settings. Displayed fields depend on the selected trigger type. Selection changes take effect immediately.

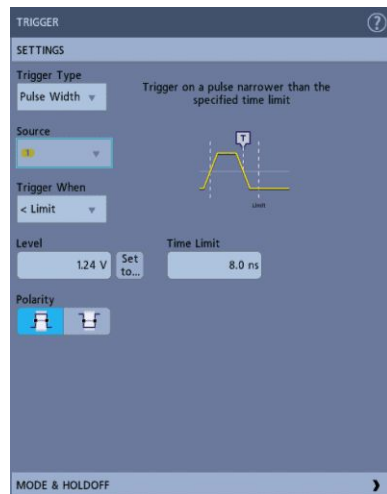

4. Tap the Help icon on the menu title for more information on these settings.
5. Tap outside the menu to close the menu.

Set the acquisition mode

Use this procedure to set the method the instrument uses to acquire and display the signal.

1. Double-tap the **Acquisition** badge on the Settings bar to open the Acquisition configuration menu.
2. Select the acquisition method from the **Acquisition Mode** list. Set any other parameters associated with the selected acquisition type.



3. Tap the Help icon on the menu title for more information on these settings.
4. Tap outside the menu to close the menu.

Start and stop an acquisition

Acquisition controls the start and stop of waveform acquisition.

1. To start an acquisition, double-tap the Acquisition badge and tap **Run/Stop** in the Acquisition configuration menu. You can also push the **Run/Stop** button on the front panel.



2. To stop an acquisition, tap **Run/Stop** again or push the **Run/Stop** button.
3. To take a single acquisition, double-tap the Acquisition badge and tap **Single/Seq** in the Acquisition configuration menu or push the **Single/Seq** button on the front panel.
4. The color of the **Run/Stop** and **Single/Seq** buttons on the front panel indicate the acquisition status (green = acquiring; red = stopped).
5. To clear the current acquisition data from waveform memory, double-tap the Acquisition badge and tap **Clear** in the Acquisition configuration menu, or push the **Clear** button on the front panel.

Add a channel waveform to the display

Use this procedure to add a channel signal to the display.

1. Connect signal(s) to the channel input(s).
2. Tap an Inactive Channel button (in the Settings bar) of a connected channel.

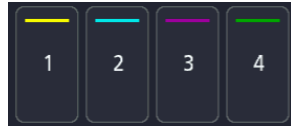

The selected channel is added to the Waveform View, and a Channel badge is added to the Settings bar.

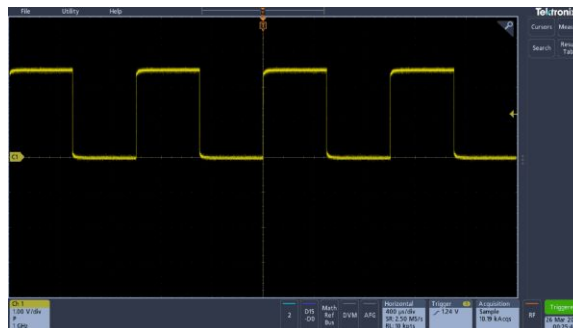

3. Continue tapping Inactive Channel buttons to add more channels (digital or analog).

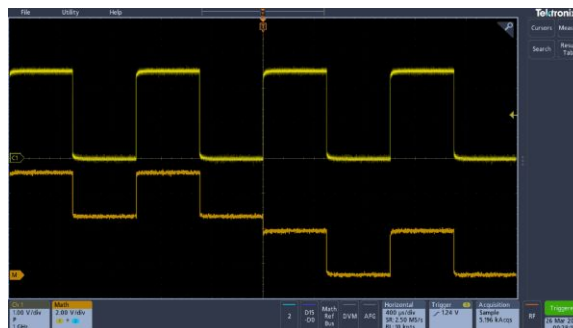

4. Double-tap a channel badge to open that channel's configuration menu to check or change settings. See [Configure channel or waveform settings](#) on page 74.

Configure channel or waveform settings

Use the channel and waveform configuration menus to set parameters such as vertical scale and offset, coupling, bandwidth, probe settings, deskew values, external attenuation, and other settings.

Prerequisite: There is a channel or waveform badge in the Settings bar.

1. Double-tap a **Channel** or **Waveform** badge to open a configuration menu for that item.

For example, in a Channel menu, use the **Vertical Settings** panel to set basic parameters such as vertical scale and position, offset, coupling, termination, and bandwidth limit.



Available settings depend on the probe.



2. Tap the **Probe Setup** panel to confirm probe settings and run configuration or compensation on supported probes.

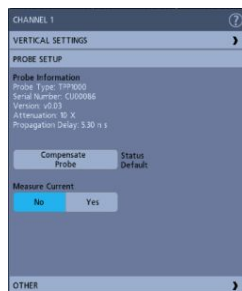

3. Tap the **Other** panel to set probe deskew and external attenuation parameters.

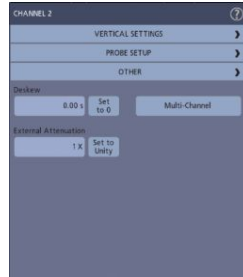

4. Tap the Help icon on the menu title to open the help topic for more information.
5. Tap outside the menu to close the menu.

Add a math, reference, or bus waveform

Math waveforms let you create new waveforms based on operations between two or more waveforms or by applying equations to waveform data. A reference waveform is a static waveform record displayed for comparison. Bus waveforms let you view and analyze serial or parallel data.

You can add 1 Math, 4 Reference (2 Reference on a 2 channel instrument), or 2 Bus waveforms to the Waveform View.

1. Tap the **Add Math Ref Bus** button in the Settings bar and select from the available waveforms.

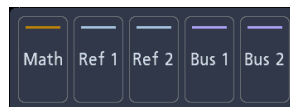

2. The instrument adds the waveform to the Waveform view and adds a Waveform badge to the Settings bar. This example shows adding the Math waveform.

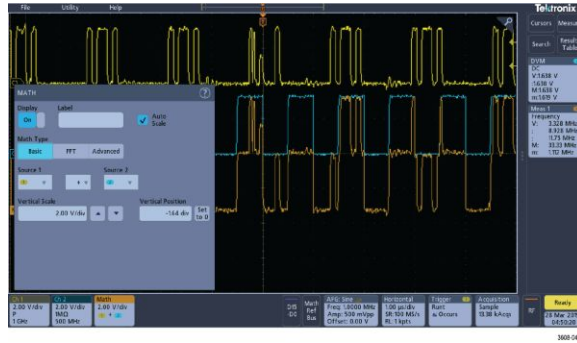

- Use the configuration menus to refine the waveform parameters. Displayed fields depend on the waveform and selections made in the menu. Selection changes take effect immediately.

This example shows adding a Math waveform by using the Math **Source** fields to select Ch 1 and Ch 2 as the waveform sources, setting the math type to **Basic** math operation, and subtracting channel 2 from channel 1.



- When adding a Reference waveform, if a reference is not defined, the instrument displays a **Recall** configuration menu. Navigate to and select the reference waveform file (*.isf) to recall, then tap the **OK, Recall Waveform** button. The instrument displays the Reference waveform.
- Double-tap a math, reference, or bus badge to check or change that waveform's settings. See [Configure channel or waveform settings](#) on page 74.
- Tap the Help icon on a configuration menu title for more information on math, reference, and bus waveform settings.
- Tap outside the menu to close the menu.

Add a measurement

Use this procedure to select and add measurements.

1. Acquire the channel(s) and/or waveform(s) on which you want to take measurements.

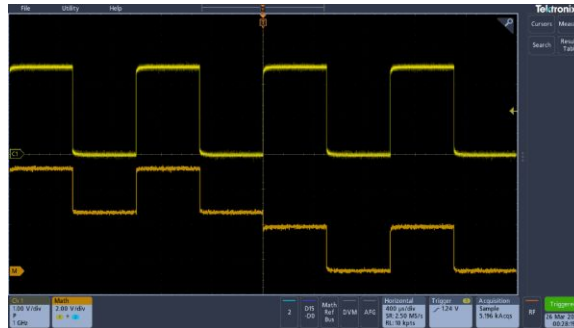

NOTE. Waveforms do not need to be displayed to be used for measurements as long as the channel or waveform badge is on the **Settings** bar and is acquiring the signal to measure.

2. Tap the **Measure** button to open the **Add Measurements** configuration menu.



NOTE. If the menu shows tabs, then optional measurement types have been installed on the instrument. Select a tab to show the measurements for that option.

NOTE. If frequency domain (RF) is active, tapping the **Measure** button opens the **Add Measurements** configuration menu for RF.

3. Tap the **Source** field and select the measurement source. The list shows all available sources that are valid for the measurement.

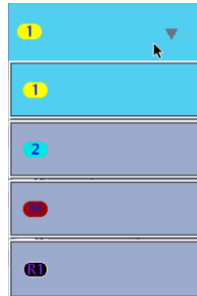

4. Select from the configuration menu panels, such as **Amplitude Measurements**, **Timing Measurements**, and **Other**, to display measurements for those categories.
5. Select a measurement and tap **Add** to add the measurement to the **Results** bar.



6. Select and add other measurements for the current source. Tap the measurement category panels to display and select other measurements to add.
7. To add measurements for other sources, select a different source, select a measurement, and add the measurement.

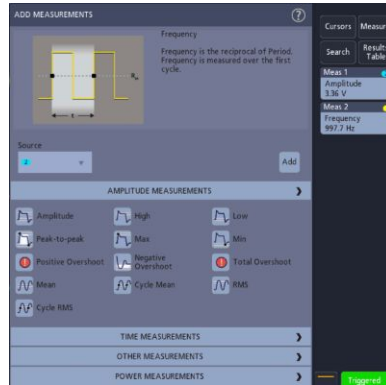

8. Tap outside the **Add Measurements** menu to close the menu.
9. To further adjust a measurement's settings, double-tap a measurement badge to open a configuration menu for that measurement. See [Configure a measurement](#) on page 79.
10. Tap the Help icon on the menu title for more information on settings.

Configure a measurement

Use this procedure to add statistical readouts to the measurement badge and refine measurement parameters (configuration, global versus local scope of settings, gating, and so on).

1. Double-tap a measurement badge to open its **Measurement** configuration menu.

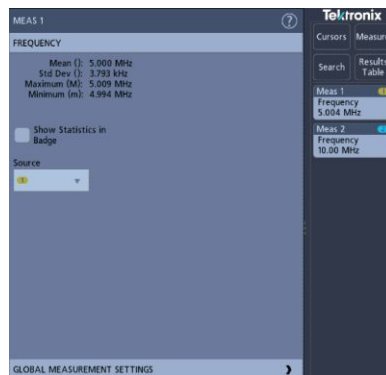

2. Tap **Show Statistics in Badge** to add statistical readouts to the measurement badge.

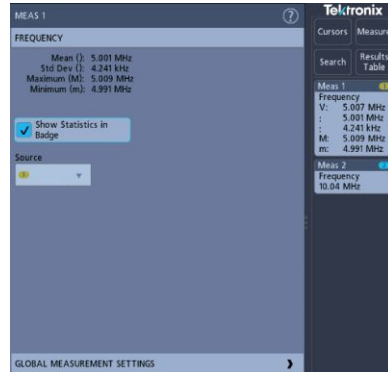

3. Tap available panel titles to make changes for those categories.

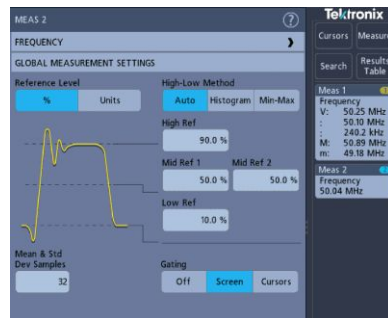

4. Use the available fields to refine the measurement conditions. Displayed fields depend on the measurement. Selection changes take effect immediately. Selection changes can also change fields in other panels.
5. Tap the Help button on the menu title for more information on this menu's settings.
6. Tap outside the menu to close the menu.

Delete a measurement or search badge

Use this procedure to remove a Measurement or Search badge from the Results bar.

1. Touch and hold the Measurement or Search badge that you want to delete. The instrument opens a right-click menu.
2. Select **Delete Meas** or **Delete Search** to delete that badge from the Results bar.

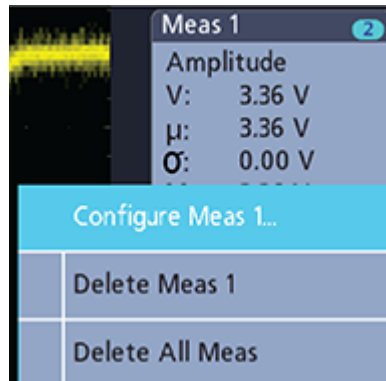

3. You can also delete a Measurement or Search badge by dragging it off the display. You can use the mouse to drag and delete a badge.

Display an XY waveform

Use this procedure to display an XY waveform.

XY display mode displays the amplitude from one waveform against the amplitude from another.

1. Double-tap the **Acquisition** badge.

The Acquisition configuration menu is displayed.

2. Tap **XY Display** to toggle the mode on or off.

A data point from the first waveform specifies the horizontal location while the corresponding data point from the second waveform specifies the vertical location for each displayed point.

Display an FFT math waveform

Use this procedure to display an FFT math waveform.

The FFT process mathematically converts the standard time-domain signal (repetitive or single-shot acquisition) into its frequency components. The FFT function processes the waveform record and displays the FFT frequency domain record, which contains the input signal frequency components from DC (0 Hz) to $\frac{1}{2}$ the sample rate (also called the Nyquist frequency).

1. Tap **Add Math Ref Bus** and then tap **Math**.
2. Double-tap the **Math** badge to open the Math configuration menu.
3. Tap **Source** and select the signal source from the list.
4. Set Math Type to **FFT**.

The FFT of the waveform is displayed in an FFT Math waveform view.

5. Use the controls to further refine the FFT display.

Add a search

Use this procedure to set search criteria and mark a waveform where those events occur.

You can search on analog and digital signals, math waveforms, and reference waveforms. Prerequisite: Display the channel or waveform signal on which to search. The waveform must be displayed to create a search for it.

1. Display the channel or waveform signal on which to search. The waveform must be displayed to create a search for it.
2. Tap the **Search** button to open the Search configuration menu.

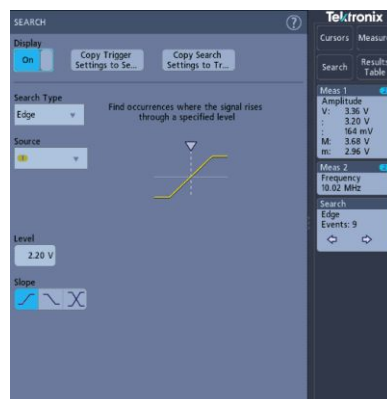

3. Use the configuration menu fields to set the search criteria in the same way that you would set for a trigger condition (select the **Search Type**, **Source**, and conditions on which to search).

- The searched waveform is marked with one or more triangles as soon as the search criteria becomes true. The example image shows search criteria set to find positive pulse widths that are less than 70 ns wide.

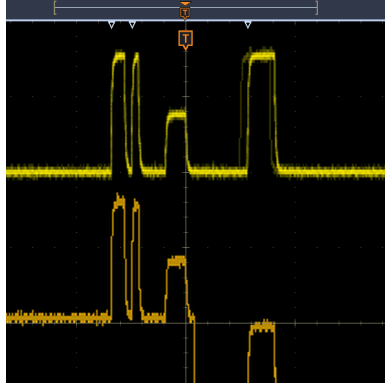

- To stop showing marks on a waveform, double-tap the **Search** badge and tap **Display to Off**.
- To move the waveform to center marks on the display, push the **Run/Stop** front panel button to stop acquisition, single-tap a **Search** badge, and tap the < or > Navigation button.

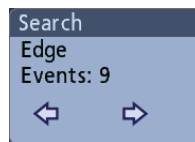

This opens the **Zoom** mode and moves the waveform to the previous or next event mark on the waveform.

- To return the instrument to normal acquisition mode, tap the **Zoom** icon in the upper right corner of the Waveform View to turn off **Zoom** mode, and then push the **Run/Stop** front-panel button to set it to Run mode.

Change waveform view settings

Use this procedure to change the waveform persistence, style, and intensity; graticule style and intensity; and screen annotation.

1. Double-tap on an open graticule area to open the **Waveform View** configuration menu.



2. Use the controls to set the waveform point persistence, style, and intensity, graticule style and intensity, and screen annotation.
3. Tap the **Help** icon on the menu title to open the Waveform View menu help topic for more information on the waveform view parameters.
4. Tap outside the menu to close the menu.

Display and configure cursors

Cursors are on-screen lines that you can move to take measurements on specific parts of a waveform. Cursor readouts show both current position values and the difference (delta) between cursors.

1. Tap the **Cursors** button, or push the front-panel **Cursors** button.
The cursors are added to the display.



2. Use Multipurpose Knobs **A** and **B** or touch and drag to move the cursors. Cursors show readouts that show position and difference measurements between the cursors.
3. To further configure cursors, double-tap on either cursor line or the cursor readouts to open the **Cursors** configuration menu. For example, tap the Cursor type to select the cursors to display, such as Waveform.

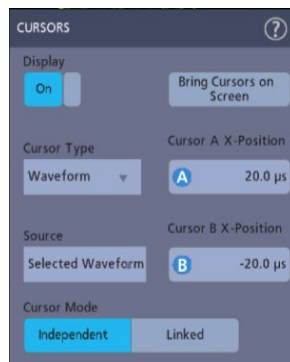

4. Tap the Help icon on the menu title for more information on the menu settings.
5. To stop showing cursors, push the front panel **Cursor** button or open the Cursors configuration menu and set Display to **Off**.

Using Default Setup

Use Default Setup to restore instrument settings to their factory defaults.

1. Press the front panel **Default Setup** button to return the instrument to its factory default settings (horizontal, vertical, scale, position, and so on).

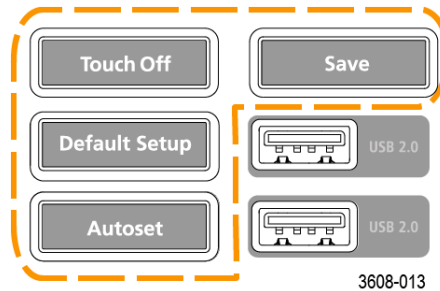

2. You can also select **File > Default Setup** to restore default settings.

Using Fast Acq

Fast Acq (fast acquisition mode) reduces the dead time between waveform acquisitions, enabling the capture and display of transient events such as glitches or runt pulses. Fast acquisition mode can also display waveform occurrences at intensity levels that reflect their rate of occurrence.

1. To use Fast Acquisition mode, double-tap the **Acquisition** badge. Tap Acquisition mode and select **Fast Acq** from the list. You can also push the **Fast Acq** front-panel button.

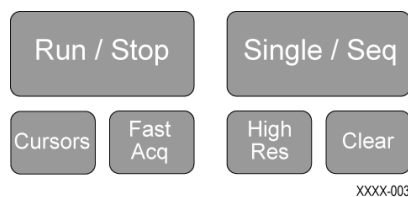

2. To display waveform phenomena at an intensity that reflects their rate-of-occurrence, after selecting the **Fast Acq** acquisition mode, tap **Fast Acq Palette** and select a display palette from the drop-down list.

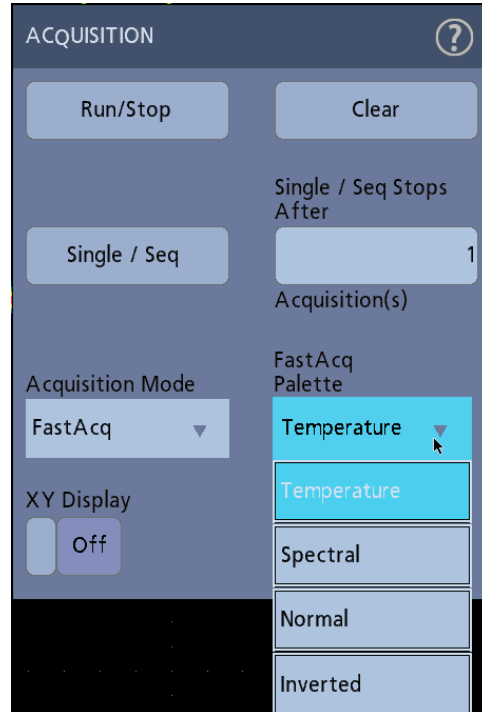

3. **Fast Acq** displays waveform phenomena at an intensity that reflects their rate-of-occurrence
4. View the waveform to find glitches, transients, or other random events. When you have identified an anomaly, use the advanced trigger system to capture the event of interest for further analysis.

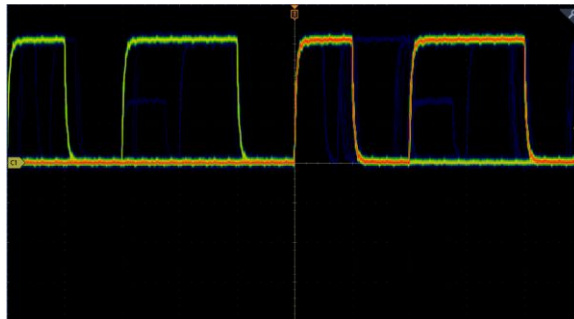

NOTE. *If Fast Acquisitions mode is on and you attempt to activate a feature that conflicts with this mode, Fast Acquisitions mode will be disabled. When the conflicting feature is turned off, Fast Acquisitions will resume in most cases.*

Remote access from a Web browser

You can remotely access your network-connected instrument from a Web browser to display the instrument user interface on a PC.

This procedure describes how to remotely access the UI controls and screen for the instrument.

Prerequisites:

- The oscilloscope must be connected to, and accessible from, the network to which the PC is connected. See [Connect to a network \(LAN\)](#) on page 61
 - Determine the IP address of the oscilloscope that you want to access. To determine the oscilloscope's IP address, select **Utility > IO** in the oscilloscope menu bar and view the network settings in the **LAN** panel.
1. Open a Web browser on a PC connected to the same network as the oscilloscope.
 2. Enter just the oscilloscope IP address on the URL line of the browser and press **Enter**. For example: 135.62.88.157. The browser searches for and opens the Web page for the oscilloscope.

Connect the oscilloscope to a PC using a USB cable

Use a USB cable to connect the oscilloscope directly to a PC for remote instrument control.

1. On the oscilloscope, select **Utility > I/O** from the menu bar.
2. Tap **USB Device Port**.
3. Confirm that the USB Device Port control is **On** (default setting).
4. Connect a USB cable from the PC to the **USB Device** port on the rear of the instrument.
5. If using the USB connection to remotely control the oscilloscope using GPIB commands, set the **GPIB Talk/Listen Address** for your configuration (0 - 30).

Acquiring digital signals

Acquiring digital signals

Connect a P6316 logic probe to digital input. Connect the logic probe inputs to the DUT (see the probe instructions). Then use the following topics to set up, acquire, and display digital signals.

- [Connect and set up digital signals](#) on page 89
- [Add a serial bus to the Waveform view](#) on page 92
- [Add a parallel bus to the Waveform view](#) on page 94

Connect and set up digital signals

Use the digital Channel configuration menu to set up the digital channels to acquire signals.

Digital channel configuration menus are available only if a supported digital logic probe is attached to the oscilloscope.



CAUTION. To prevent damage to the instrument always wear an antistatic wrist strap when making connections to the instrument and DUT. Always observe the maximum input voltage ratings for input connectors.

1. Connect the logic probe to the instrument. Tap the D15-D0 . The digital signal waveforms are opened on the screen.
2. Connect the probe to the signal sources. Use the accessories in the Tektronix Probe accessory Kit (shipped with the probe) to connect to your DUT.

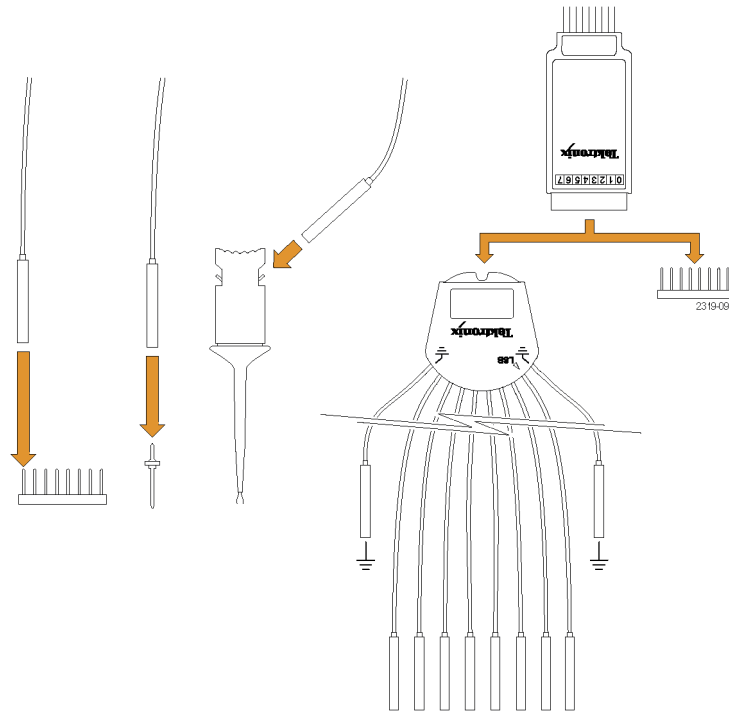

3. Double-tap the **D15-D0** button to open the Digital configuration menu. Set up digital channels to match your digital logic requirements.



4. Tap **Display** to toggle the digital channel group On or Off.
5. To change the displayed height of the digital channels, tap a **Height** button.
6. Tap a **Bit** control to toggle individual digital channel bits On or Off and remove them from the displayed logic waveform.
7. Tap a **Threshold** field and use multipurpose knob **A** to set bit threshold levels. You can also set the thresholds by double-tapping the field and setting the threshold using the virtual keypad.
8. Use the bit **Label** fields to enter labels for the individual digital channel bits (D0-D15). Double-tap on the field and use the virtual keyboard to enter label text. Or tap the field and use an attached keyboard to enter label text.
9. Tap **Turn All Off** to turn all digital bits Off (D15-D7 or D7-D0).

Add a serial bus to the Waveform view

Use this procedure to add a serial bus to the Waveform view.

This instrument supports decoding parallel buses (standard with the instrument) and several serial buses options (see [Serial bus decode and trigger options](#) on page 9). All serial bus functions are options that must be purchased and installed before they are available in the instrument menus.

Use a Bus configuration menu to define a bus from which to acquire, decode, and display data.

1. Tap the **Add Math Ref Bus** button on the Settings bar and then tap **Bus** to add a Bus badge to the Settings bar and add a bus waveform to the screen. The default bus type is parallel.

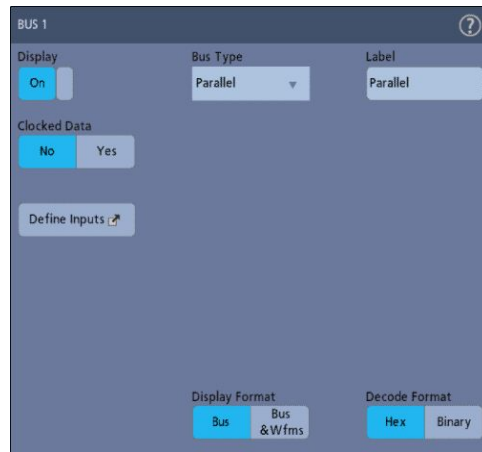

2. Double tap the **Bus** badge to open the Bus Configuration menu.
3. Tap **Bus Type** and select the bus type from the drop-down list.



- Use the fields and controls to select the bus signal sources, thresholds, other parameters, and the output format. The following example shows the settings for an I²C serial bus.



The decoded bus is updated on the screen as you make changes to the settings.



- Tap outside of the Bus configuration menu to close it.
- Double-tap the **Trigger** badge and use the Trigger configuration menu to trigger on a specific condition in the bus.

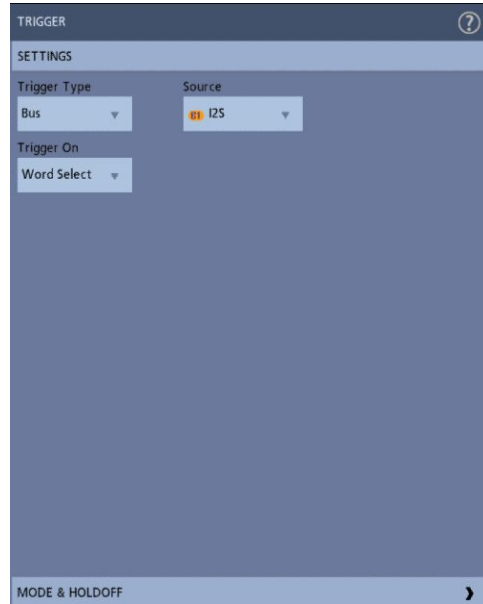

7. For more information on serial bus settings, tap the Help button on the Bus configuration menu.

Add a parallel bus to the Waveform view

Use this procedure to add a parallel bus to the Waveform view.

When you acquire data from a Parallel bus, you can set up the bus to be clocked or unclocked. If the bus is not clocked, the instrument acquires all data from the parallel bus at the sample rate of the instrument.

1. Tap the **Add Math Ref Bus** button on the Settings bar and then tap **Bus** to add a Bus badge to the Settings bar and add a bus waveform to the screen. The default bus type is parallel.
2. Double tap the **Bus** badge to open the Bus Configuration menu.



3. If setting up a clocked bus:

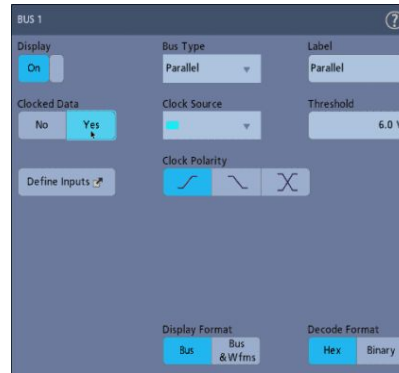

- a. Set Clocked Data to **Yes**.
 - b. Tap the **Clock Source** field and select the source for the parallel bus clock signal.
 - c. Tap the **Clock Polarity** and **Threshold** controls and set the clock signal transition to detect and threshold level, respectively.
4. Tap **Define Inputs** and select the signal sources for the parallel bus. Signal sources can be analog or digital. Tap a signal in the Sources list to add it to the bus list on the left.

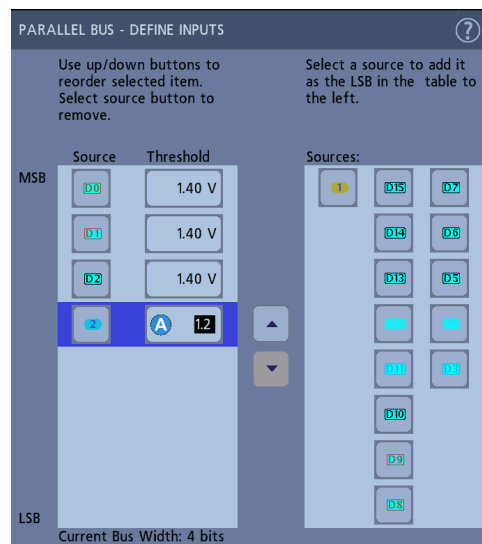

The bus waveform updates as you make changes on the configuration menu. Tap the + symbol next to the waveform handle to turn on and off showing the signals associated with the bus waveform.

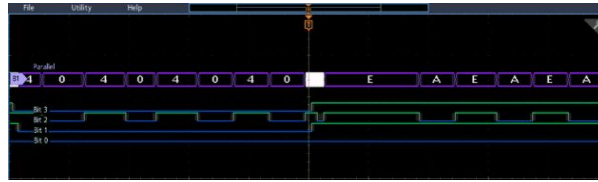

5. Use the rest of the fields and controls in the configuration menu to set up the parallel bus parameters (label, position, display and decode formats).
6. Tap outside of the Bus configuration menu to close it.
7. To get a stable triggered waveform, double-tap the **Trigger** badge, set the Trigger Type to **Bus**, select the bus Source to the parallel bus you just set up, and enter the data condition on which to trigger in the **Data** field.
8. For information on parallel bus menu settings, tap the Help button on the Bus configuration menu.

Advanced triggering

Advanced triggering

You can check the advanced trigger status in the trigger menu. The menu indicates the trigger type and then shows sources, levels, or any other parameters that are important for the particular trigger type. Use the following links for more information on advanced triggering.

- [Triggering concepts](#) on page 97
- [Set Trigger Holdoff](#) on page 99
- [Trigger on sequential events \(A and B triggers\)](#) on page 100
- [Set up trigger on a parallel bus](#) on page 101
- [Set up trigger on a serial bus](#) on page 101

Triggering concepts

Overview User selected trigger conditions are used to capture waveforms for measurement and analysis.

Triggers help you capture meaningful waveforms to display on screen. This instrument has simple edge triggers as well as a variety of advanced triggers.

The trigger event The trigger event establishes the time-zero point in the waveform record. All waveform record data are located in time with respect to that point. The instrument continuously acquires and retains enough sample points to fill the pretrigger portion of the waveform record (that part of the waveform that is displayed before, or to the left of, the triggering event on screen).

When a trigger event occurs, the instrument starts acquiring samples to build the posttrigger portion of the waveform record (displayed after, or to the right of, the trigger event). Once a trigger is recognized, the instrument will not accept another trigger until the acquisition is complete and the holdoff time has expired.

Trigger on a pulse width event

Pulse-width triggering triggers the instrument when a signal pulse width is less than, greater than, equal to, or not equal to a specified pulse width. This trigger is useful for digital logic troubleshooting.

To set a pulse width trigger:

1. Double-tap the **Trigger** badge to open the Trigger configuration menu.
2. Tap **Trigger Type** and select **Pulse Width**.
3. Tap **Source** and select the trigger source.
4. Tap **Trigger When** and select the pulse width condition on which to trigger (> Limit, < Limit, = Limit, ≠ Limit, Outside Range, Inside Range).

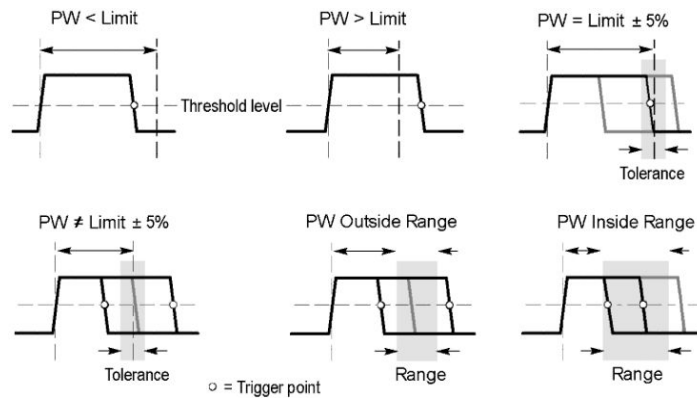

5. Set the pulse width time constraints:
 - a. For all Trigger When conditions except Outside Range or Inside Range, tap the **Time Limit** field and use the assigned multipurpose knob to set the pulse width time condition to meet.
 - b. For Outside Range or Inside Range conditions, tap the **High Time Limit** and **Low Time Limit** fields and use the assigned multipurpose knobs to set the pulse width time range condition to meet.
6. Tap the **Level** field and set the threshold value at which you want to measure pulse width.
7. Select the pulse polarity on which to trigger.

Set Trigger Holdoff

Trigger Holdoff sets the time, after triggering on an event, that the instrument waits before detecting the same trigger event to start the next acquisition.

Setting the correct holdoff time is important to get a stable trigger. The longer holdoff time for the top waveform causes unstable triggering. The shorter holdoff set for the bottom waveform only triggers on the first pulse in the burst to remedy the unstable trigger.

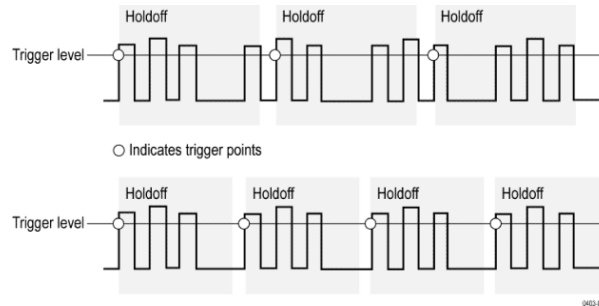

1. Double-tap the **Trigger** badge on the Settings bar to open the Trigger configuration menu.
2. Tap the **Mode & Holdoff** panel.
3. To set a specific holdoff time, tap **Holdoff** and use the assigned multipurpose knob to specify a holdoff time. Or double-tap the field and use the virtual keypad to enter a holdoff time.

Trigger on sequential events (A and B triggers)

Use the A and B Trigger Events to trigger on a second event after a first event occurs.

Set up sequential triggering

1. Double-tap the **Trigger** badge to open the Trigger configuration menu.
2. Tap **Trigger Type** and select **Sequence**. Sequence triggering uses Edge triggering for both the A and B trigger types.
3. Set up the A Trigger Event:
 - a. Tap **A Source** and select the A event trigger source.
 - b. If displayed, tap **Coupling** and select the trigger coupling.
 - c. Tap **A Level** and set the desired trigger level using the multipurpose knob. Or double-tap the field to set the value using the virtual keypad.
 - d. Tap a **A Slope** button to select the slope of the signal on which to trigger (Rise or Fall).
4. Set up the B Trigger Event:
 - a. Tap **B Source** and select a trigger source.
 - b. Tap **B Level** and set the desired trigger level using the multipurpose knob. Or double-tap the field to set the value using the virtual keypad.
 - c. Tap a **B Slope** button to select the slope of the signal on which to trigger (Rise or Fall).
5. To trigger on a specific occurrence of the B trigger event:
 - a. Tap After the A Trigger Event is found: **Trigger on the Nth Trigger Event** button in the main Trigger menu.
 - b. Tap **Where N is:** and use the multipurpose knob to set the oscilloscope to trigger on the Nth occurrence of a B trigger event.
6. To trigger on the B event after a specific time delay:
 - a. Tap After the A Trigger Event is found: **Trigger on the 1st B Event** button.
 - b. Tap **After a Delay of:** and use the multipurpose knob to set the desired delay time to wait before detecting and triggering on a B trigger event. You can also double-tap the field and use the virtual keypad to enter a delay time.

Set up trigger on a parallel bus

Use this procedure to set up triggering on a parallel bus.

Use this procedure if you have already created a parallel bus.

1. Double-tap the **Trigger** badge.
2. Tap the **Trigger Type** field and select **Bus** from the list.
3. Tap the **Source** field and select the parallel bus on which to trigger.
4. Tap either the **Binary** or **Hex** Data boxes to enter the parallel bus data value, in either Binary or Hexadecimal format, on which to trigger. The number of bits shown depends on the number of sources (channels) in the parallel bus.
 - a. Use multipurpose knob A to select the digit or digits to change.
 - b. Use multipurpose knob B to change the value of the selected digits.

Set up trigger on a serial bus

Use this procedure to set up triggering on a serial bus.

Use this procedure if you have already created a serial bus. Serial buses require the purchase and installation of serial bus options. See [Serial bus decode and trigger options](#) on page 9.

1. Double-tap the **Trigger** badge on the Settings bar.
2. Tap **Trigger Type** and select **Bus** from the list.
3. Tap **Source** and select a serial bus from the list.
4. Tap **Trigger On** and select what to trigger on from the list. The displayed fields and controls depend on the bus type and Trigger On selection. Use these fields to trigger on a specific bus condition.

Trigger using the AUX input

Use this procedure to trigger the instrument from an external signal connected to the AUX input.

1. Double-tap the **Trigger** badge on the Settings bar.
2. Tap **Trigger Type** and select **Edge** from the list.
3. Tap **Source** and select **Aux**.

NOTE. *Aux is only available for the Edge trigger type. Aux is only available on 2 channel instruments.*

4. Set the values for **Coupling**, **Level**, and **Slope** to trigger on the Aux connector signal.

Setting waveform display parameters

Setting waveform display parameters

Use waveform display controls to set the persistence, style, and intensity display parameters, and graticule style and intensity.

Use the following topics for more information on setting display parameters.

- [Set the waveform persistence style and intensity](#) on page 103
- [Set the graticule style and intensity](#) on page 104

Set the waveform persistence style and intensity

Use the Waveform View configuration menu to set waveform persistence, style, and intensity.

1. Double-tap on an open graticule area to open the Waveform View menu.
2. Tap the **Persistence** field to select the persistence option.
 - **Off** disables display persistence.
 - **Auto** lets the oscilloscope automatically determine a persistence time for you.
 - **Infinite** persistence continuously accumulates record points until you change one of the acquisition display settings. Use infinite persistence for displaying unique signal anomalies, such as glitches.
 - **Variable** persistence accumulates record points for a specified time interval. Each record point decays independently according to the time interval. Use variable persistence for displaying infrequently appearing signal anomalies, such as glitches.

If you select Variable persistence, tap **Variable Persistence** and set the time using the multipurpose knob or double-tap the field and use the virtual keypad to enter the time value.

3. Tap the Waveform Style buttons to set waveforms to draw as vectors (continuous lines) or dots.
 - **Vectors** displays the waveform with the waveform sample values connected by vectors.
 - **Dots** displays the individual waveform sample values.
4. Tap the **Waveform Intensity** field and use the multipurpose knob to set the brightness of all waveforms.

Set the graticule style and intensity

Use this procedure to set the graticule (display grid) style and intensity.

1. Double-tap on an open graticule area to open the Waveform View configuration menu.
2. Tap the **Graticule Style** field to select a graticule style from the list.

Full shows a frame, cross hairs, and a grid on the instrument display. This style is useful for making quick, full-screen measurements with cursors and automatic readouts when cross hairs are not needed.

Grid, **Solid**, and **Cross Hair** provide compromises between Frame and Full.

Frame provides a clean screen on which you can most easily read automatic measurement results and other screen text.

3. Tap the **Graticule Intensity** field and use the multipurpose knob to set the brightness of all graticules.

Zooming on waveforms

Zooming on waveforms

Use the zoom tools to magnify waveforms to view signal details.

Turn on Zoom mode

Zoom mode lets you look at a portion of your waveform in greater detail. Enable Zoom mode and touch and drag on-screen to select the area to zoom.

To enable Zoom mode, do the following:

1. Tap the Zoom icon in the corner of display.

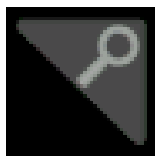

2. Zoom overview:
 - a. To use Zoom once enabled, use pinch and/or drag options in the zoom view to change the zoomed area of interest.

NOTE.

Pinch, expand, and drag gestures in the Zoom View only change zoom magnification settings and Zoom Box position.

Use the A and B multipurpose knobs to adjust the scale and position of the zoom from the front panel controls. Select either the Horizontal Zoom Scale or the Zoom Position field to assign knob A and B for zoom adjustment. A and B icons are displayed in the field when a knob is assigned.

- b. To exit the zoom display mode, tap the Zoom icon in the corner of display or tap the X in the Zoom Title Bar.
3. For more information on zoom:
 - [Zoom user interface elements](#) on page 51
 - [Zoom mode and Searches](#) on page 106

Zoom mode and Searches

Use Zoom and Searches to find events of interest on a waveform.

Searches provide a way to mark a waveform event or events for reference. You can set marks automatically with search criteria such as particular edges, pulse widths, runts, logic states, rise/fall times, setup and hold, and bus data types.

When in Zoom mode, you can tap the Search badge and use its navigation buttons to position the waveform to the previous or next search marks.

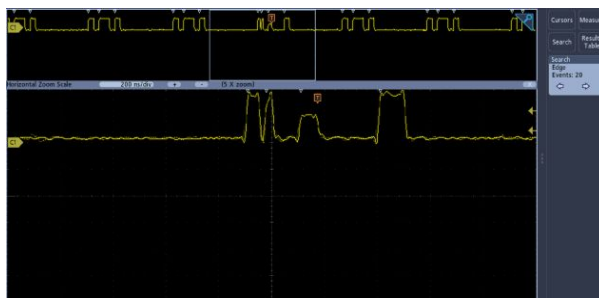

For information on creating a Search, see [Add a search](#) on page 82.

Customizing measurements

Customizing measurements

After adding a measurement, you can customize the measurement for more precise results by using gating or setting reference levels.

To customize measurements, double-tap a Measurement badge in the Results bar to open the *Measurement configuration menu* on page 129.

See the following topics for more information.

- **Reference levels** determine how time-related measurements are taken. See *Set measurement reference levels* on page 107.
- **Gating** confines the measurement to a certain portion of a waveform. See *Set measurement gates* on page 108.

Set measurement reference levels

Use this procedure to set measurement reference levels.

Reference levels are set in the Global Measurement Settings panel of the Measurements configuration menu. See *Measurement configuration menu* on page 129.

Prerequisite: To set measurement reference levels you must be taking a measurement. See *Add a measurement* on page 77.

1. Double-tap a Measurement badge.

The Measurement configuration menu is displayed.

2. Tap the **Global Measurement Settings** panel.
3. Tap **Reference Levels** and select either **%** or **Units**.
 - **%** sets the High, Mid, and Low reference levels as percentages of the calculated High and Low signal levels. Tap the **High Ref**, **Mid Ref**, or **Low Ref** fields and set the level using the assigned multipurpose knob. Or double-tap the field and use the virtual keypad to enter a value.
 - **Units** sets the High, Mid, and Low reference levels to specific signal levels. Tap the **High Ref**, **Mid Ref**, or **Low Ref** fields and set the level using the assigned multipurpose knob. Or double-tap the field and use the virtual keypad to enter a value.
4. Tap **High-Low Method** and select the method.
 - **Auto** automatically chooses the method.
 - **Hysteresis** is best for pulses.
 - **Min-Max** is best for all other waveforms.

5. Tap anywhere outside the Measurement configuration menu to close it.

Set measurement gates

Use this procedure to specify which portion of your waveform is used to take measurements.

Gating is set in the Global Measurement Settings panel of the Measurements configuration menu. See [Measurement configuration menu](#) on page 129.

To set measurement gates you must be taking a measurement. See [Add a measurement](#) on page 77.

1. Double-tap a measurement badge to open the Measurement configuration menu.
2. Tap the **Global Measurement Settings** panel.
3. Tap Gating and either **Off**, **Screen**, or **Cursors** gating:
 - **Off** takes measurement across the entire waveform record.
 - **Screen** takes measurements on that portion of the waveform shown in the display. When Zoom is on, the display is the zoom window.
 - **Cursors** takes measurements on that portion of the waveform between the cursors. Selecting Cursors opens cursors on the measurement source. Set the cursors so that the waveform area of interest is between the cursors.
4. Tap anywhere outside the Measurement configuration menu to close it.

Saving and recalling information

Use these procedures to save or recall waveforms, setups, or traces.

The oscilloscope provides permanent storage for setups and waveforms. Use the internal storage of the oscilloscope to save setup files and reference waveform data.

Use external storage, such as USB drives or network drives, to save setups, waveforms, and screen images. Use the external storage to carry data to remote computers for further analysis and for archiving. USB drives must be FAT32 file systems.

External file structure. If you are saving information to external storage, select the appropriate file.

Drive name	Drive letter	Drive or physical USB port location
Root drive	Instrument Storage	User-accessible memory on the oscilloscope
Front panel	E	USB 2.0 (top)
	F	USB 2.0 (bottom)
Rear panel	G	USB 2.0
	H	USB 2.0 device port provides USBTMC support
Network location	I through Z	Network storage locations

Browse to select the file location. Tap the + buttons to navigate to and select a location at which to save the file.

Naming your file.

The oscilloscope gives all files it creates a default name in the following format:

tekXXXXX.set for setup files where XXXXX is an integer from 00000 to 99999

tekXXXXX.png, tekXXXXX.bmp, or tekXXXXX.tif for image files

tekXXXXYYY.csv for spreadsheet files or tekXXXXYYY.isf for internal format files

For waveforms, the XXXX is an integer from 0000 to 9999. The YYY is the channel of the waveform, and can be one of the following:

CH1, CH2, CH3, or CH4 for the analog channels

D00, D01, D02, D03, and so on through D15 for the digital channels

MTH for a math waveform

RF1, RF2, RF3, or RF4 for reference memory waveforms

For RF traces, XXXX is an integer from 0000 to 9999. The YYY defines the trace and can be one of the following:

NRM for a normal trace

AVG for an average trace
MAX for a maximum hold trace
MIN for a minimum hold trace
TIQ for a baseband I & Q file

NOTE. Analog, digital, and RF waveforms and traces and those waveforms and traces derived from them (such as math and references) can be saved to an ISF file.

The XXXX value will automatically increment each time you save a file of the same type. For example, the first time you save a file, that file is named tek00000. The next time you save the same type of file, the file will be named tek00001.

NOTE. You can override the automatically generated filename with a custom name.

Save a screen image

Use this procedure to save a screen image.

1. Tap the **File** menu and select **Save As**.

The Save As configuration menu opens.

2. Tap **Screen Capture** to open the Screen Capture tab.
3. Browse to select the location to save the file.
 - a. Tap the + buttons to navigate to and select a location at which to save the file.
4. **File Name** shows the name last used to save a file. The default name is Tek000. To change the file name, double-tap the file name and enter a new file name using the virtual keyboard.
5. Tap **Format** and select the desired graphic image file type from the list.
6. Tap **Ink Saver** to turn the Ink Saver mode on or off. When on, this mode provides a white background.
7. Tap **OK Save Screen Capture** to save the screen image to the specified file name, location, and type.

NOTE. Once you have saved a file using the Save As configuration menu, you can push the front-panel **Save** button to immediately save the same type file again, without opening any menus.

Save a waveform to a file

Use this procedure to save channel waveform (analog or digital) data to a comma-separated values (csv) or Tektronix waveform data (wfm) file, for later analysis or inclusion in reports.

1. Tap the **File** menu and select **Save As**.

The Save As configuration menu opens.

2. Tap **Waveform** to open the Waveform tab.

NOTE. The instrument can save digital waveforms to .csv files, not reference memories. The oscilloscope cannot recall digital waveforms.

NOTE. The instrument can save, but not recall, RF acquisitions as .TIQ files. You can use .TIQ files with Tektronix SignalVu Vector Signal Analysis software.

3. Browse to select the location to save the file.
 - a. Tap the + buttons to navigate to and select a location at which to save the file.
4. **File Name** shows the name last used to save a file. The default name is Tek000. To change the file name, double-tap the file name and enter a new file name using the virtual keyboard.
5. Tap **Format** and select the desired waveform format.

When saving RF trace data, you can select to save it as either the standard display data or as baseband I and Q data (.TIQ files). Use the I and Q data with Tektronix SignalVu Vector Signal Analysis software.

6. Tap **Gating** and select the desired gating from the list.
7. Tap **OK Save Waveform** to save the waveform to the specified file name, location, and type.

NOTE. Once you have saved a file using the Save As configuration menu, you can push the front-panel Save button to immediately save the same type file again, without opening any menus.

Save instrument settings to a file

Use this procedure to save instrument settings to a Tektronix setup (.set) file.

1. Tap the **File** menu and select **Save As**.

The Save As configuration menu opens.

2. Tap **Setup** to open the Setup tab.
3. Browse to the location to save the file.
 - a. Tap the + buttons to navigate to and select a location at which to save the file.
4. **File Name** shows the name last used to save a file. The default name is Tek000. To change the file name, double-tap the file name and enter a new file name using the virtual keyboard.
5. Tap **Save** to save the setup information to the specified file name and location.

NOTE. *Once you have saved a file using the Save As configuration menu, you can push the front-panel **Save** button to immediately save the same type file again, without opening any menus.*

Save all

Use this procedure to save all file types including: screen capture, waveforms, and setup files.

The save all function saves each file type according to the latest save settings in the **Screen Capture**, **Waveform**, and **Setup** tabs. All files saved use the user-specified filename followed by extensions that distinguish the file types. The types of files saved is determined by the configuration of your instrument.

An instrument configured for time domain acquisitions saves a screen capture, all waveforms, and a setup file. An instrument configured for frequency domain acquisitions saves a screen capture, all waveforms, a setup file, and a CSV file. The CSV file contains the frequency and amplitude of each peak identified by automatic peak markers.

1. Tap the **File** menu and select **Save As**.

The Save As configuration menu opens.

2. Confirm that the **Screen Capture**, **Waveform**, and **Setup** settings are setup for the desired output.
3. Tap **All** to open the save all tab.

NOTE. *An external drive (USB) must be connected to save all file types.*

4. Browse to select the location to save the files.
 - a. Tap the + buttons to navigate to and select a location at which to save the file.

NOTE. *The file names cannot be changed when saving all file types. All files saved use an auto-assigned file name followed by extensions that distinguish the file types.*

5. Tap **Save** to save all file types to the specified file names and location.

NOTE. *Once you have saved a file using the Save As configuration menu, you can push the front-panel Save button to immediately save the same type file again, without opening any menus.*

Recall a Reference waveform

Use this procedure to recall (load) and display a saved waveform as a Reference waveform. There are 4 (or 2) reference waveforms that you can load and display.

Display a reference waveform

Use this procedure to display a saved reference waveform.

1. Tap the **Add Math Ref Bus** button on the Settings bar and then tap **Ref 1**, **Ref 2**, **Ref 3**, or **Ref 4** to add a Ref badge to the Settings bar and add a Ref waveform to the screen.
2. To change the display of the reference, double-tap the **Ref** badge to open the Ref configuration menu. See [Reference waveform configuration menu](#) on page 234 for more information.

Recall a reference waveform

Use this procedure to recall (load) a saved waveform as a Reference waveform.

1. Tap **File** and then select **Recall**.
This displays the Recall menu.
2. Tap the **Recall Waveform** tab.
3. Tap a **Recall To** button to specify the reference to load the waveform in.
4. Use the + and - buttons to navigate the file directory. Navigate to the folder that contains the file to recall.
5. Select the file to recall
6. Tap **OK Recall Waveform**.

The reference waveform is loaded and displayed, and a Ref badge is added to the Settings bar.

Recall a Setup file

Use this procedure to recall (load) and configure instrument settings from a Setup file.

1. Select **File > Recall** from the Menu bar to open the *Recall configuration* menu.
2. Tap **Setup** to open the Setup tab.

The Recall configuration menu opens.

3. Navigate to the folder that contains the file to recall, using the following methods:
 - Tap a + button to open a folder and show its contents.
 - Tap a - button to close a folder and stop showing its contents.
4. Select the file to recall.

NOTE. *You can double-tap on a file name to immediately recall the file and close the menu.*

5. Tap **OK Recall Setup**

The instrument loads the setup file and reconfigures the oscilloscope to the setup file settings.

Menus and dialog boxes

The Acquisition configuration menu

Use this configuration menu to set parameters for acquiring waveform data points and to enable XY mode.

To open the Acquisition menu, double-tap the **Acquisition** badge on the Settings bar.

The Acquisition menu fields and controls

Displayed fields and controls can change depending on menu selections.

Field or control	Description
Run/Stop	Toggles the oscilloscope between constant acquisition (Run) and no acquisitions (Stop). When stopped, the oscilloscope shows waveforms from the last completed acquisition.
Single/Seq	Acquires a single acquisition or a set number of acquisitions, then stops.
Clear	Erases acquired waveform data points from memory. Applies to all live acquisition waveforms.

Field or control	Description
Acquisition Mode	<p>Sample creates a record point by saving one or more samples during each acquisition interval. Sample mode is the default acquisition mode. The instrument does no post processing of the acquired samples in this mode.</p> <p>Peak Detect alternates between saving the highest sample in one acquisition interval and the lowest sample in the next acquisition interval. Useful for capturing fast and random events such as narrow waveform pulses.</p> <p>High Res applies unique finite impulse response (FIR) filters based on the current sample rate. This FIR filter maintains the maximum bandwidth possible for that sample rate while rejecting aliasing. The filter removes noise from the oscilloscope amplifiers and ADC above the usable bandwidth for the selected sample rate. Implementation of the filter in hardware, ahead of the trigger and storage, reduces trigger jitter and enables using Fast Acq mode while in High Res mode.</p> <p>The High Res sample rate and record length settings are displayed in the Horizontal badge. High Res mode sets the maximum real time sample rate to ½ the maximum sample rate.</p> <p>Envelope acquires and displays a waveform record that shows the extremes in variations over several acquisitions. The instrument saves the highest and lowest values in two adjacent intervals (similar to the Peak Detect mode). Unlike Peak Detect mode, the peaks are gathered over many trigger events.</p> <p>Average acquires and displays a waveform record that is the average result of several acquisitions. This mode reduces random noise.</p> <p>FastAcq provides high-speed waveform capture. It is helpful in finding elusive signal anomalies. Fast acquisition mode reduces the dead time between waveform acquisitions, enabling the capture and display of transient events such as glitches and runt pulses. Fast acquisition mode can also display waveform phenomena at an intensity that reflects their rate of occurrence.</p>
Single Seq/Stops After	Enables stopping acquisitions after a specified number of acquisitions. Only works when using the Single/Seq button.
Number of Waveforms	Specifies the number of acquisitions for average and envelope modes.
XY Display	Toggles XY display mode on and off.

Add Measurements configuration menu overview

Use this configuration menu to select measurements you want to take on waveforms and add the measurements to the Results bar.

To open the **Add Measurements** configuration menu, tap the **Measure** button in the **Analysis** controls area.

The **Add Measurements** configuration menu always opens on the **Amplitude Measurements** panel. The listed panels and measurements depend on the installed measurement options and the selected signal source.

To add a measurement, select the input source or sources, select the measurement, and tap the **Add** button. The measurement is added to the Results bar.

To change individual measurement settings, double-tap the Measurement badge to open a configuration menu for that measurement. See [Measurement configuration menu](#) on page 129.

Add Measurements menu fields and controls

Field or control	Description
Measurement description (graphic and text)	Shows a graphic and short description of the selected measurement. Use this information to verify that the selected measurement is correct for what you want to measure.
Source	Selects the measurement source. If the measurement requires more than one source (for example, Skew, Phase, or many Power measurements), the menu shows two source fields from which to select.
Add button	Adds the selected measurement as a measurement badge to the Results bar.

Standard measurement panels

Panel	Description
Amplitude Measurements panel	Lists the available amplitude measurements. See Amplitude Measurements panel on page 118. When a digital source is selected, this panel is not available.
Time Measurements panel	Lists the available time measurements. See Time Measurements panel on page 120.
Other Measurements	Lists the available other measurements. See Other Measurements panel on page 122.
Power Measurements	Advanced Power Analysis (optional). Provides measurements for power quality, harmonics, slew rate, switching loss, safe operating area, ripple, and modulation analysis measurements. See The Power Measurements panel (optional) on page 123.

Amplitude Measurements panel

The Amplitude Measurements panel lists available amplitude-related measurements that you can take on analog channel signals, math waveforms (time-domain), and reference waveforms. Amplitude measurements are not available for digital signals.

To open the Amplitude Measurements panel:

1. Tap the **Measure** button.
2. Tap the **Amplitude Measurements** panel.

To add a measurement to the Results bar:

1. Select the signal source.
2. Select a measurement.
3. Tap **Add**.

The Amplitude Measurements panel measurements.

Measurement	Description
Amplitude	The difference between the Top value and the Base value. You can take this measurement on each cycle in the waveform record or on the entire waveform record.
Peak-To-Peak	The absolute difference between the Maximum and Minimum amplitudes in the measurement region. You can take this measurement on each cycle in the waveform record or on the entire waveform record.
Positive Overshoot¹	The difference between the Maximum value and the Top value, divided by the Amplitude, and multiplied by 100 to express the measurement as a percentage of amplitude. You can take this measurement on each cycle in the waveform record or on the entire waveform record.
Negative Overshoot¹	The difference between the Minimum and Base values, divided by the Amplitude, and multiplied by 100 to express the measurement as a percentage of amplitude. You can take this measurement on each cycle in the waveform record or on the entire waveform record.
Mean	The arithmetic mean of all data points over the measurement region. You can take this measurement on each cycle in the waveform record or on the entire waveform record.
Cycle RMS	The true Root Mean Square voltage over the first cycle in the waveform or the first cycle in the gated region.
High	This value is used as 100% whenever high reference, mid reference, or low reference values are needed, such as in fall time or rise time measurements. Calculate using either the min/max or histogram method. The min/max method uses the maximum value found. The histogram method uses the most common value found above the midpoint. This value is measured over the entire waveform or gated region.
Low	This value is used as 0% whenever high reference, mid reference, or low reference values are needed, such as in fall time or rise time measurements. Calculate using either the min/max or histogram method. The min/max method uses the minimum value found. The histogram method uses the most common value found below the midpoint. This value is measured over the entire waveform or gated region.
Maximum	The maximum data point value. You can take this measurement on each cycle in the waveform record or across the entire waveform record.
Minimum	The minimum data point value. You can take this measurement on each cycle in the waveform record or on the entire waveform record.
Total Overshoot	The summation of the positive overshoot and the negative overshoot.
Cycle Mean	The arithmetic mean over the first cycle in the waveform or the first cycle in the gated region.
RMS	The true Root Mean Square voltage over the entire waveform or gated region.

See also. [Measurement configuration menu](#) on page 129

¹ Changing your High-Low Method in the Global Measurement Settings panel of the Measurement configuration menu may change how this value is calculated.

Time Measurements panel

Use the Time Measurements panel to add timing-related measurements to the Results bar. Timing measurements can be taken on time-domain analog, math, and reference waveforms. Timing measurements can also be taken on some digital channel signals.

To open the Time Measurements panel:

1. Tap the **Measure** button.
2. Tap the **Time Measurements** panel.

To add a measurement to the Results bar:

1. Select the signal source.
2. Select a measurement. If a measurement requires two signal sources, select both sources.
3. Tap **Add**.

Time Measurements panel.

Measurement	Description
Period ²	The time between two adjacent crossings of the Mid reference level (one cycle) of the waveform. The measurement is taken on each cycle of the waveform record or measurement region.
Frequency ²	The frequency of the waveform. Frequency is the reciprocal of Period (Frequency = 1/Period).
Delay	The time difference between the mid reference (default 50%) amplitude point of two different waveforms. You can specify the signal edges to measure in the measurement's Configuration menu. The measurement requires two sources.
Phase ²	The time difference (phase shift) between the specified signal edges of waveform source 1 and waveform source 2. The measurement is expressed in degrees, where 360° comprise one waveform cycle. This measurement requires two sources. The measurement is taken on each cycle of the waveform record.
Positive Pulse Width ²	The distance (time) between the mid reference (default 50%) amplitude points of a positive pulse. The measurement is made on the first pulse in the measurement region.
Negative Pulse Width ²	The distance (time) between the mid reference (default 50%) amplitude points of a negative pulse. The measurement is taken on each cycle in the waveform record or measurement region.
Positive Duty Cycle ²	The ratio of the positive pulse width to the signal period, expressed as a percentage. The duty cycle is measured on the first cycle in the measurement region.
Negative Duty Cycle ²	The ratio of the negative pulse width to the signal period, expressed as a percentage. The duty cycle is measured on the first cycle in the measurement region.
Rise Time	The time required for the leading edge of the first pulse in the measurement region to rise from the low reference value (default = 10%) to the high reference value (default = 90%). The measurement is taken on each cycle of the waveform record.
Fall Time	The time required for the trailing edge of the first pulse in the measurement region to fall from the high reference value (default = 90%) to the low reference value (default = 10%). The measurement is taken on each cycle of the waveform record.
Burst Width	The duration of a series of adjacent crossings of the Mid reference level. Bursts are separated by a specified idle time. The measurement is taken on each burst in a waveform record.

See also. [Measurement configuration menu](#) on page 129

² This measurement can also be taken on digital signals.

Other Measurements panel

Use the Other Measurements panel to add pulse count, edge count, and area measurements to the Results bar. Other measurements can be taken on time-domain analog, math, and reference waveforms. Other measurements can also be taken on some digital channel signals.

To open the Other Measurements panel:

1. Tap the **Measure** button.
2. Tap the **Other** measurements panel.

To add a measurement to the Results bar:

1. Select the signal source.
2. Select a measurement. If a measurement requires two signal sources, select both sources.
3. Tap **Add**.

Other Measurements panel.

Measurement	Description
Positive Pulse Count	The number of positive pulses that rise above the mid reference crossing in the waveform or gated region.
Negative Pulse Count	The number of negative pulses that fall below the mid reference crossing in the waveform or gated region.
Rising Edge Count	The number of positive transitions from the low reference value to the high reference value in the waveform or gated region.
Falling Edge Count	The number of negative transitions from the high reference value to the low reference value in the waveform or gated region.
Area	Area measurement is a voltage over time measurement. It returns the area over the entire waveform or gated region in volt-seconds. Area measured above ground is positive; area measured below ground is negative.
Cycle Area	A voltage over time measurement. The measurement is the area over the first cycle in the waveform or the first cycle in the gated region expressed in volt-seconds. The area above the common reference point is positive, and the area below the common reference point is negative.

See also. [Measurement configuration menu](#) on page 129

The Power Measurements panel (optional)

The Power panel lists the power-related measurements that you can add to the Results bar. Power measurements include power quality, switching loss, harmonics, ripple, modulation, and safe operating area. The Power Measurements panel is shown only if you have purchased and installed the Power Measurement and Analysis option.

To open the Power Measurements panel:

1. Tap the **Measure** button.
2. Tap the **Power** measurements panel.

To add a measurement to the Results bar:

1. Tap a measurement.
2. Tap **Add**.

Power Measurements panel (optional).

Measurement	Description
Power Quality	Measures the Frequency, RMS values of the voltage and current, Crest Factors of the voltage and current, Real Power, Reactive Power, Apparent Power, Power Factor, and Phase Angle of the AC signal.
Switching Loss	Measures power loss and energy loss across the acquired waveform, including turn-on, turn-off, conduction, and total loss.
Harmonics	Measures the signal amplitudes at the fundamental line frequency and its harmonics. Measures the RMS amplitude and Total Harmonic Distortion of the signal. Plots the Harmonics Bar Graph.
Ripple	Measures ripple and statistics for the AC components of the acquired waveform.
Modulation	Measures the modulation value across the acquired waveform.
Safe Operating Area	Measures the switching device-under-test's voltage and current. Also, performs a mask test of the X-Y signal relative to the graphical X-Y description of the device specification limits.

Power Quality Measurements panel (optional).

Measurement	Description
Voltage Source	Select which channel the voltage waveform is on. Frequently, for these measurements, you will select a channel pair, where channel 1 is used as a voltage source and channel 2 as a current source. The Voltage and Current sources can be any analog waveforms, whether live channels or references.
Current Source	Select which channel the current waveform is on. Frequently, for these measurements, you will select a channel pair, where channel 1 is used as a voltage source and channel 2 as a current source. The Voltage and Current sources can be any analog waveforms, whether live channels or references.
Frequency Reference	Select the source for the zero crossings for all Power Quality measurements and for frequency.
Global Measurement Settings	Set reference levels, gating, samples, and Hysteresis level. See Global Measurement Settings panel (Measurement configuration menu) on page 131

Switching Loss Measurements panel (optional).

Measurement	Description
Voltage Source	Select which channel the voltage waveform is on.
Current Source	Select which channel the current waveform is on.
Gate Voltage (Vg)	Select which channel the gate voltage is on.
Vg Polarity	Select the gate polarity.
Vg Ton Level	Set the gate Ton level. This control is only present when Gate Voltage (Vg) is set to something other than None.
Conduction Calculation	Set the conduction calculation method. Voltage Waveform measures the voltage drop across the switching device during conduction. Because this voltage is typically very small compared with the voltage across the switching device when it is not conducting, you generally cannot measure both voltages accurately at the same vertical setting of the oscilloscope. In that case, consider using RDS(on) or Vce(sat) for more accurate results.
RDS(on)	RDS(on) is the best model for MOSFETs and is based on information from the device data sheet. This value is the expected on-resistance between the drain and the source of the device when it is conducting. This control is only present when Conduction Calculation is set to MOSFET.
Vce(sat)	VCE(sat) is the best model for BJTs and IGBTs and is based on information from the device data sheet. It is the expected saturation voltage from the collector to the emitter of the device when it is saturated. This control is only present when Conduction Calculation is set to BJT/IGBT.
Badge Results	Select which of the available switching loss measurements to display. The choices are Power loss or Energy loss.
Ton-Start & Toff-Stop Current Level	Set the Ton-Start & Toff-Stop Current Level. This control is only present when Gate Voltage (Vg) is set to None.
Ton-Stop & Toff-Start Voltage Level	Set the Ton-Stop & Toff-Start Voltage Level.
Toff-Stop Current Level	Set the Toff-Stop Current Level. This control is only present when Gate Voltage (Vg) is set to something other than None.
Global Measurement Settings	Set reference levels, gating, and Hysteresis level. See Global Measurement Settings panel (Measurement configuration menu) on page 131

Harmonics Measurements panel (optional).

Measurement	Description
Voltage Source	Select which channel the voltage waveform is on.
Current Source	Select which channel the current waveform is on.
Harmonics	Specify the number of harmonics to calculate. whether to calculate harmonics on the voltage or the current waveform, and how to determine the frequency of the primary waveform.
Standard	Select between general harmonics analysis or testing to a specific standard, such as IEC 61000-3-2 Class A or MIL-STD-1399 Section 300A.
Harmonics Source	Specify whether to calculate harmonics on the voltage or the current waveform.
Frequency Reference	Select how to determine the frequency of the primary waveform. Choices are None, IEC 61000-3-2, V, I, Fixed.
Fixed Reference	Specify the fixed reference frequency of the primary waveform. This control is only available when Frequency Reference is set to Fixed.
Display	Selects the harmonics to display.
Line Frequency	Select the line frequency of the DUT .
Class	Select the class from the drop-down list. Available values are A, B, C (Table 1), C (Table 2), C (Table 3), and D.
Observation Period (OP)	Enter the observation period.
Set Scale & RL for OP	Sets the scale and record length for the observation period.
Power Factor	Enter the power factor. This control is only present when Class is set to Class C, Tables 1, 2, or 3.
Current	Enter the current. This control is only present when Class is set to Class C, Tables 1, 2, or 3.
Input Power	Enter the input power, This control is only present when Class is set to Class C, Table 3 or Class D.
Filter (1.5 s)	Toggles the filter on and off.
Grouping	Toggles the grouping on and off.
Set to IEC Defaults	Sets to IEC defaults.
Horizontal	Sets the horizontal scale for greater than 10 cycles.
Power Level	Select a High or Low power level.
Current	Select either measured or rated current.
Rated Current	When rated current is selected, enter the current value.
Global Measurement Settings	Set the Hysteresis level. See Global Measurement Settings panel (Measurement configuration menu) on page 131

Ripple Measurements panel (optional).

Measurement	Description
Voltage Source	Select which channel the voltage waveform is on.
Current Source	Select which channel the current waveform is on.
Ripple Source	Select which channel to measure the ripple on.
Do Vertical Autoset	Removes the DC component from the signal by adding vertical offset and then auto-scaling the AC component for optimal measurement accuracy. Typically, a ripple measurement involves looking at a very small voltage riding on a large voltage. You want to use the internal resolution of the oscilloscope as effectively as possible to measure that small voltage. With Do Vertical Autoset, you can devote much more of the oscilloscope's ADC range to measurement of the desired ripple.
Set Offset to 0 V	Removes all vertical offset.

Modulation Measurements panel (optional).

Measurement	Description
Voltage Source	Select which channel the voltage waveform is on.
Current Source	Select which channel the current waveform is on.
Modulation Source	Select which channel to measure the modulation on.
Modulation Type	Select what to measure. Choices include: positive pulse width, negative pulse width, period, frequency, positive duty cycle, and negative duty cycle.
Global Measurement Settings	Set the reference levels. See Global Measurement Settings panel (Measurement configuration menu) on page 131

Safe Operating Area Measurements panel (optional).

Measurement	Description
SOA Pair	Select which channels to measure. For this measurement, there are four valid voltage/current input pairs. These are Ch1/Ch2, Ch3/Ch4, Reference 1/Reference 2, and Reference 3/Reference 4.
Axes	Select either a log or linear graticule. Use the max and min menu items and multipurpose knob a to set the size of the graticule. The x axis typically displays voltage and the y axis displays current.
Y Axis Max	Set the Y axis maximum value.
Y Axis Min	Set the Y axis minimum value.
X Axis Max	Set the X axis maximum value.
X Axis Min	Set the X axis minimum value.
Stop On Violation	Select whether or not to stop acquisitions on the detection of an error.
Mask Settings panel	Define a mask for the measurement. See SOA Mask definition controls and fields on page 134

Mask Settings panel (optional).

Measurement	Description
Define Mask	Selects setting limits or setting points to define a mask.
Maximum Voltage	Set the maximum voltage using a multipurpose knob or double-tap and set the value using the displayed keypad.
Maximum Current	Set the maximum current using a multipurpose knob or double-tap and set the value using the displayed keypad.
Maximum Power	Set the maximum power using a multipurpose knob or double-tap and set the value using the displayed keypad.
Define Mask	Lists the points that define a mask. Set the X and Y values using the multipurpose knobs.
Insert Point	Inserts a new mask point.
Delete Point	Deletes the selected mask point.
Clear Table	Deletes all mask points.

See also. [Power measurement configuration menu overview \(optional\)](#) on page 133

[Global Measurement Settings panel \(Measurement configuration menu\)](#) on page 131

[SOA Mask definition controls and fields](#) on page 134

Measurement configuration menu

Use this configuration menu to add statistics to a measurement badge readout and change measurement settings including source, reference levels, high-low method, gating, and number of samples.

To open a Measurement configuration menu for a measurement, double-tap a Measurement badge in the Results bar. The configuration menu and panels only show fields and controls relevant to the selected measurement.

The menu opens on the measurement name panel (the name of the measurement), which provides controls to display additional statistics to the measurement badge, reference levels, gating, and so on. The content of the measurement name panel depends on the measurement. The most common Measurement Name fields are listed in the following table.

Measurement configuration menu fields, controls, and panels

Field, control, or panel	Description
Measurement Statistics (Measurement name panel)	A list of measurement statistics related to the measurement. You can add these statistics to a measurement badge by selecting the Show Statistics in Badge control.
Show Statistics in Badge (Measurement name panel)	Adds the listed statistical measurement readouts to the measurement badge readout.
Source (Measurement name panel)	Sets the source and slope for the measurement. The number of controls is specific to each measurement type.
Info: (Measurement name panel)	Displays measurement warnings for the measurement.
Global Measurement Settings panel	Sets the reference levels and units used to take measurements, the gating method, the method used to calculate the Top and Base waveform values, and the number of samples. See Global Measurement Settings panel (Measurement configuration menu) on page 131 for more information.

**Measurement Name panel
(Measurement configuration menu)**

The Measurement Name panel (the name of the measurement) provides controls for adding measurement statistics to the measurement badge and opening plots of the measurement.

To open the measurement name panel, double-tap a Measurement badge. This is the default panel shown when you open a Measurement settings menu.

The content of the Measurement Name panel depends on the measurement.

Field or control	Description
Measurement Statistics	A list of measurement statistics. You can add these statistics to a measurement badge by selecting the Show Statistics in Badge control.
Info: (Measurement name panel)	Displays measurement warnings for the measurement.
Show Statistics in Badge	Select to add the listed statistical measurement readouts to the measurement badge.
Source 1 (From) (Measurement name panel)	Sets Source 1 for the measurement. Tap and select the source from the list. This control is only available when the measurement type is Delay or Phase.
Source 1 Edge (Measurement name panel)	Sets the edge direction of the source. Tap to select the positive or negative edge of the source. This control is only available when the measurement type is Delay.
Source 2 (To) (Measurement name panel)	Sets Source 2 for the measurement. Tap and select the source from the list. This control is only available when the measurement type is Delay or Phase.
Source 2 Edge (Measurement name panel)	Sets the edge direction of the source. Tap to select the positive or negative edge of the source. This control is only available when the measurement type is Delay.
Source 2 Edge Occurrence	Specifies whether the Source 2 Edge occurs before or after the Source 1 Edge .
Global Measurement Settings panel	Sets the reference levels and units used to take measurements, the gating method, the method used to calculate the Top and Base waveform values, and the number of samples. See Global Measurement Settings panel (Measurement configuration menu) on page 131.

See also.

[Global Measurement Settings panel \(Measurement configuration menu\)](#) on page 131

**Global Measurement
Settings panel
(Measurement
configuration menu)**

Use the Global Measurement Settings panel to set the reference levels (High, Mid, and Low), the units used to take measurements, gating, and the method used to calculate the High and Low waveform values.

To open the Global Measurement Settings panel:

1. Tap the **Measure** button.
2. Tap the **Global Measurement Settings** panel.

Global Measurement Settings panel- fields and controls.

Field or control	Description
Reference Levels	Sets the method used to set or calculate the High, Mid, and Low reference levels. Select % or Units and use the Multipurpose Knob to set custom reference values.
High-Low Method	<p>Sets the method to calculate the waveform High and Low values, which is then used to calculate the High, Mid, and Low reference levels.</p> <p>Auto is the default method, and automatically determines the best High-Low method to use. Most commonly sets the method to Histogram Mode.</p> <p>Min-Max Uses the minimum and maximum values in the waveform record to determine the high and low amplitude. Useful on a waveform with low noise and free from excessive overshoot.</p> <p>Histogram Mode uses histogram analysis to calculate the most common values above and below the waveform midpoint. High is set to the common high value, and Low is set to the common low value.</p> <hr/> <p><i>NOTE. All measurements that you add to the Results bar will use the new High-Low Method values for taking measurements.</i></p>
High Ref, Mid Ref 1, Mid Ref 2, Low Ref, Vg Mid Ref	<p>Sets the reference levels as specified percentages of the High and Low waveform measurement or as absolute values.</p> <p>To set custom reference values, tap a setting field, and use the Multipurpose Knob to set the different % (relative) or absolute values.</p> <p>High Ref and Low Ref references are used to calculate rise and fall times. The default High reference is 90% and Low reference is 10%.</p> <p>Mid Ref 1 and Mid Ref 2 references are primarily used for measurements between edges such as pulse widths. The default level is 50%.</p> <p>Vg Mid Ref sets the mid reference when the Gate Voltage is set to something other than None. This control is only available with the 3MDOPWR power measurement option Switching Loss measurement.</p>
Gating	<p>Sets the gate type used to take measurements.</p> <p>Off: Measurements are taken across the entire record.</p> <p>Screen: Measurements are taken on the portion of the waveform shown on the display. When zoom is on, the 'display' on which to measure is the zoom window.</p> <p>Cursors: Measurements are taken on the portion of the waveform between the cursors. When Cursors is selected, use the multipurpose knobs to select the portion of the waveform to measure.</p>

Field or control	Description
Hysteresis	Set the hysteresis amount. This setting applies hysteresis to the frequency reference level. Harmonics, Switching Loss, and Power Quality all use the frequency of the signal as part of their calculation. Hysteresis defines a region around the reference level relative to the amplitude of the signal. This prevents noisy signals from creating multiple crossings that ruin the frequency calculation. Increase the hysteresis to prevent the noise from affecting the frequency measurement.
Mean & Std Dev Samples	Sets the number of samples used in a mean and standard deviation measurement.

Power measurement configuration menu overview (optional)

Use this configuration menu to add statistics to a Power measurement badge readout and change measurement settings including source, reference levels, and gating.

To open the Power measurement configuration menu for a measurement, double-tap a Power measurement badge in the Results bar. The configuration menu and panels only show fields and controls relevant to the selected measurement.

The menu opens on the measurement name panel (the name of the measurement), which provides controls to display additional statistics to the measurement badge. The measurement name panel only shows fields and controls relevant to the selected measurement. The most common Power measurement Name fields are listed in the following table.

Power Measurement configuration menu fields, controls, and panels

Field, control, or panel	Description
Measurement Statistics (Measurement name panel)	A list of measurement statistics related to the measurement. You can add these to a measurement badge by selecting the Show Statistics in Badge control.
Show Statistics in Badge (Measurement name panel)	Adds the listed statistical measurement readouts to the measurement badge readout.
Voltage Source	Select the source from the drop-down list.
Current Source	Select the source from the drop-down list.
Mask Settings Panel	Define a mask for the safe operating area (SOA) measurement.
Global Measurement settings panel	Sets the reference levels, gating, mean and standard deviation samples, and hysteresis used to take measurements.

Power Measurement Name panel (Measurement configuration menu)

The Power Measurement Name panel (the name of the measurement) provides controls for adding display statistics to the measurement badge.

To open the power measurement name panel, double-tap a Power Measurement badge. This is the default panel shown when you open a Power Measurement settings menu.

The contents of the Measurement Name panel depends on the measurement.

Field or control	Description
Measurement Statistics	Shows a list of measurement statistics. You can add these statistics to a measurement badge by selecting the Show Statistics in Badge control.
Show Statistics in Badge	Adds the listed statistical measurement readouts to the measurement badge.

See also.

[Measurement Name panel \(Measurement configuration menu\)](#) on page 130

[Global Measurement Settings panel \(Measurement configuration menu\)](#) on page 131

SOA Mask definition controls and fields

Use the SOA Mask dialog to configure the parameters to add point, delete point, save mask, and recall mask.

Use the parameters to define the linear mask for an SOA measurement.

Define Mask fields and controls

Field or control	Description
Define Mask	Select between defining a mask by setting limits or defining points. Use Set Points to define a more complex mask with up to 10 points, each of which you can define.
Maximum Voltage	Define the safe operating area by creating a four-point mask by setting the maximum voltage, current, and power.
Maximum Current	
Maximum Power	
Define Mask	Define the voltage (X) and amperage (Y) for each mask point.
X (Volts)	Define voltage values for the mask point.
Y (Amps)	Define current values for the mask point.
Insert Point	Add voltage and current points to define mask. Points are added to the end of the existing list.
Delete Point	Deletes the selected point data row.
Clear Table	Clears the values of the mask coordinates in the table.

**Reference Levels panel
(Power measurement
configuration Menu)**

Use the Global Measurement Settings panel to set the reference levels, the units used to take measurements, gating, and the method used to calculate the High and Low waveform values.

See [Global Measurement Settings panel \(Measurement configuration menu\)](#) on page 131 for the Reference panel fields and controls.

Other measurement settings panels. [Power Measurement Name panel \(Measurement configuration menu\)](#) on page 134

Bus configuration menu

Use the Bus menu to select the bus type to display, configure the input sources, and set how to display the bus on the screen.

To open the Bus configuration menu:

- For an existing bus, double-tap the **Bus** badge in the Settings bar.
- To add a new Bus badge on the Settings bar, tap the **Add Math Ref Bus** button and select **Bus**. This adds the Bus badge to the Settings bar .
- Double-tap the Bus badge. This opens the Bus configuration menu

**Bus configuration menu -
fields and controls**

Field or control	Description
Display	Toggles bus display on or off.
Label	Allows entry of label text in this field. The default label is the bus type.
Bus Type	Select a bus from the drop down list. The Parallel bus type comes standard on the instrument. Serial buses require purchase and installation of serial bus triggering and analysis options. See Serial bus decode and trigger options on page 9.
Source configuration	Specifies the bus signal input parameters. Shown fields depend on the selected bus type. See the individual bus configuration help topics for information on their settings.
Display format	Enables showing just the decoded bus or both the bus and its digital subwaveforms. You can also tap on the + symbol on the bus waveform to toggle between showing the bus only or showing bus and source waveforms. Digital waveforms represent the logical waveforms for each signal after they have been digitized. If the decode is not working as expected, you can look at the individual waveforms to see if things like suboptimal threshold settings are causing incorrect decoding.
Decode format	Sets how decoded data information is shown in the bus. Select from listed formats. Available formats depend on the bus type.

NOTE. *These controls are common to all bus types. Controls unique to specific bus types are discussed in separate topics for each bus.*

Other bus types

Serial bus types, such as CAN, LIN, Ethernet, and so on, are available as purchasable options. Once purchased and installed, the new bus types are shown in the Bus Type menu. The serial bus options also add corresponding bus trigger capabilities to the **Trigger** menu.

Use the following links to access information on specific Bus configuration menus.

[Parallel Bus configuration menu](#) on page 149

[I2C serial bus configuration menu](#) on page 144

[SPI serial bus configuration menu](#) on page 153

[RS-232 serial bus menu](#) on page 151

[CAN serial bus configuration menu](#) on page 140

[LIN serial bus configuration menu](#) on page 146

[FlexRay serial bus configuration menu](#) on page 143

[Audio serial bus configuration menu](#) on page 138

[USB serial bus configuration menu](#) on page 155

[MIL-STD-1553 serial bus menu](#) on page 147

[ARINC429 serial bus menu](#) on page 136

ARINC429 serial bus menu

Use the ARINC429 bus menu (optional) to set up and decode an ARINC429 avionics network serial bus.

To decode an ARINC429 serial bus:

- Tap the **Add Math Ref Bus** badge on the Settings bar and select **Bus1** or **Bus2**. Open the bus configuration menu by double clicking on the new Bus badge. Set the **Bus Type** to **ARINC429**.
- To change the settings on an existing ARINC429 serial bus waveform, double-tap the **Bus** waveform badge and make necessary changes.

ARINC429 serial bus menu fields and controls.

Field or control	Description
Display	Turns on or off displaying the bus in the Waveform view.
Label	Enter a label for the bus. The default label is the selected bus type. To enter label text, double-tap the field and enter label using the virtual keyboard, or tap the field and enter text using an attached keyboard.
Bus Type	Set to ARINC429 .
Polarity	Select the polarity to match the ARINC429 bus being acquired.
Source	Select the ARINC429 signal source.
High Threshold, Low Threshold	Sets the valid high and low threshold values for the signal source.
Bit Rate	Sets the bit rate to 12,500, 100,000, or Custom.
Custom Rate	Sets a custom data bit rate. To set the value, tap the field and use the Multipurpose knob, double-tap the field and use the Custom Rate virtual keypad, or double-tap the field and use an attached keyboard. This field is only visible when Bit Rate = Custom.
Data Format	Sets the data format to Data (19 bits), SDI (Source/Destination Identifiers) plus Data (21 bits), or SDI plus Data plus Sign/Status Matrix (SSM) (23 bits).
Display Format	Sets the waveform view to show just the decoded bus information, or the decoded bus and the logical views of each constituent signal.
Decode Format	Sets the decode format used to display the bus information. Formats are Hex, Binary, and Mixed Hex. Mixed Hex displays labels as octal, and other fields are formatted as hexadecimal.

Other bus types. Serial bus types, such as CAN, LIN, Ethernet, and so on, are available as purchasable options. Once purchased and installed, the new bus types are shown in the Bus Type menu. The serial bus options also add corresponding bus trigger capabilities to the **Trigger** menu.

Use the following links to access information on specific Bus configuration menus.

[Parallel Bus configuration menu](#) on page 149

[I2C serial bus configuration menu](#) on page 144

[SPI serial bus configuration menu](#) on page 153

[RS-232 serial bus menu](#) on page 151

[CAN serial bus configuration menu](#) on page 140

[LIN serial bus configuration menu](#) on page 146

[FlexRay serial bus configuration menu](#) on page 143

[Audio serial bus configuration menu](#) on page 138

[USB serial bus configuration menu](#) on page 155

[MIL-STD-1553 serial bus menu](#) on page 147

[ARINC429 serial bus menu](#) on page 136

See also.

[Bus Trigger configuration](#) on page 237

[Bus Search configuration menus](#) on page 159

Audio serial bus configuration menu

Use the Audio bus menu (optional) to set up and display I2S, Left Justified (LJ), Right Justified (RJ), or TDM Audio serial bus waveforms.

To decode an Audio serial bus:

- To create a new Audio bus waveform, tap the **Add Math Ref Bus** badge on the Settings bar and select **Bus**. Double-tap the badge to open the Bus configuration menu. Set the **Bus Type** to **Audio**.
- To change the settings on an existing Audio serial bus waveform, double-tap the **Bus** waveform badge and make the necessary changes.

Audio serial bus menu fields and controls.

Field or control	Description
Display	Turns on or off displaying the bus in the Waveform view.
Label	Enter a label for the bus. The default label is the selected bus type. To enter label text, double-tap the field and enter label using the virtual keyboard, or tap the field and enter text from an attached keyboard.
Bus Type	Set to Audio .
Audio Type	Sets the digital audio signal type. Select from the drop-down list.
Bit Order	Set the waveform to decode with most-significant (MS First) bit first or least-significant (LS First) bit first.
Bit Clock	Set the signal source, logic level threshold, and polarity (rising or falling edge) for the Bit Clock signal.
Word Select	Set the signal source, logic level threshold, and polarity (normal or inverted) signal setting for the Word signal.
Data	Set the signal source, logic level threshold, and polarity (active high or low) for the Data signal.
Word Size	Set the number of bits used in a Word for the selected audio type (4-32 bits). This field is only available when Audio Type = I2S, LJ, or RJ.
Display Format	Sets the waveform view to show just the decoded bus information, or the decoded bus and the logical views of each constituent signal..
Decode Format	Sets the decode format used to display the bus information. Choices are Hex, Binary, and Signed Decimal.
TDM-specific settings	
Frame Sync	Set the signal source, logic level threshold, and polarity (rising or falling edge) for the frame sync signal.
Data Bits per Channel	Set the number of data bits per audio channel.
Clock Bits per Channel	Set the number of clock bits per audio channel.
Channels per Frame	Set the number of audio channels per data frame.
Bit Delay	Sets the bit delay (number of bits to delay the trigger).

Other bus types. Serial bus types, such as CAN, LIN, Ethernet, and so on, are available as purchasable options. Once purchased and installed, the new bus types are shown in the Bus Type menu. The serial bus options also add corresponding bus trigger capabilities to the **Trigger** menu.

Use the following links to access information on specific Bus configuration menus.

[Parallel Bus configuration menu](#) on page 149

[I2C serial bus configuration menu](#) on page 144

[SPI serial bus configuration menu](#) on page 153

[RS-232 serial bus menu](#) on page 151

[CAN serial bus configuration menu](#) on page 140

[LIN serial bus configuration menu](#) on page 146

[FlexRay serial bus configuration menu](#) on page 143

[Audio serial bus configuration menu](#) on page 138

[USB serial bus configuration menu](#) on page 155

[MIL-STD-1553 serial bus menu](#) on page 147

[ARINC429 serial bus menu](#) on page 136

See also.

[Bus Trigger configuration](#) on page 237

[Bus Search configuration menus](#) on page 159

CAN serial bus configuration menu

Use the CAN bus menu (optional) to set up and display a CAN (Controller Area Network) or CAN FD serial bus waveform.

To create a new CAN bus waveform:

1. Tap **Add Math Ref Bus** on the Settings bar and select **Bus**.
2. Double-tap the **Bus** badge to open the bus configuration menu.
3. Set the **Bus Type** to **CAN**.

To change the settings on an existing CAN serial bus waveform, double-tap the **CAN** waveform badge on the Settings bar to open the configuration menu.

CAN serial bus menu fields and controls.

Field or control	Description
Display	Turns on or off displaying the bus in the Waveform view.
Label	Enter a label for the bus. The default label is the selected bus type. To enter label text, double-tap the field and enter label using the virtual keyboard, or tap the field and enter text from an attached keyboard.
Bus Type	Set to CAN to set up and display a CAN bus waveform.
Signal Type	Sets the CAN signal type to decode.
Standard	Sets the CAN signal standard to decode.
FD Standard	Sets the CAN signal standard to decode. Only available when Standard = CAN FD .
Source	Select the signal source from the listed analog and digital channels.
Threshold	Sets the high/low logic transition level.
Sample Point	Sets the sample point from 5% to 95% of the position within the bit period or the unit interval.
Bit Rate	Select the bit rate of your CAN bus serial data. To enter a custom bit rate, select Custom and enter the custom bit rate in the Custom Rate input box. Only available when CAN Standard = CAN 2.0 .
SD Bit Rate	Select the SD bit rate of your CAN FD serial bus data. To enter a custom bit rate, select Custom and enter the custom bit rate in the Custom Rate input box. This field is only available when CAN Standard = CAN FD .
FD Bit Rate	Select the FD bit rate of your CAN FD serial bus data. To enter a custom bit rate, select Custom and enter the custom bit rate in the Custom Rate input box. This field is only available when CAN Standard = CAN FD .
Custom Rate	Sets the custom bit rate to use to decode the signal. Tap the field and use the Multipurpose knob to change the value, or double-tap on the field and use the virtual keypad to enter a custom bit rate. This field is only available when Bit Rate, SD Bit Rate, or FD Bit Rate = Custom .

Field or control	Description
Display Format	<p>Bus sets the waveform view to show just the decoded bus information.</p> <p>Bus and Waveform sets the waveform view to show both the decoded bus and the logical views of each constituent signal.</p> <p>You can also tap on the + symbol on the bus waveform to toggle between showing the bus only or showing bus and source waveforms.</p>
Decode Format	<p>Sets the decode format used to display the bus information. Formats are Hex, Binary, and Mixed Hex. Mixed Hex displays some fields as binary, and other fields as hexadecimal.</p>

Other bus types. Serial bus types, such as CAN, LIN, Ethernet, and so on, are available as purchasable options. Once purchased and installed, the new bus types are shown in the Bus Type menu. The serial bus options also add corresponding bus trigger capabilities to the **Trigger** menu.

Use the following links to access information on specific Bus configuration menus.

- [Parallel Bus configuration menu](#) on page 149
- [I2C serial bus configuration menu](#) on page 144
- [SPI serial bus configuration menu](#) on page 153
- [RS-232 serial bus menu](#) on page 151
- [CAN serial bus configuration menu](#) on page 140
- [LIN serial bus configuration menu](#) on page 146
- [FlexRay serial bus configuration menu](#) on page 143
- [Audio serial bus configuration menu](#) on page 138
- [USB serial bus configuration menu](#) on page 155
- [MIL-STD-1553 serial bus menu](#) on page 147
- [ARINC429 serial bus menu](#) on page 136

See also.

- [Bus Trigger configuration](#) on page 237
- [Bus Search configuration menus](#) on page 159

FlexRay serial bus configuration menu

Use the Flexray bus menu (optional) to set up and display a Flexray automotive network serial bus waveform.

To set up the FlexRay serial bus:

- To create a new FlexRay bus waveform, tap the **Add Math Ref Bus** badge on the Settings bar and select **FlexRay**. Open the bus configuration menu by double clicking on the badge. Set the **Bus Type** to **FlexRay**.
- To change the settings on an existing FlexRay serial bus waveform, double-tap the **Bus** waveform badge and make necessary changes.

FlexRay serial bus menu fields and controls.

Field or control	Description
Display	Turns on or off displaying the bus in the Waveform view.
Label	Enter a label for the bus. The default label is the selected bus type. To enter label text, double-tap the field and enter label using the virtual keyboard, or tap the field and enter text using an attached keyboard.
Bus Type	Set to FlexRay .
Signal Type	Select the FlexRay signal type being measured.
Channel Type	Set to A or B channel.
Source	Select the FlexRay signal source.
Threshold	Sets the threshold value for the TX or RX signal type.
High Threshold, Low Threshold	Sets the high and low threshold values for the BM Inverted and Bdiff/BP signal types.
Bit Rate	Select a bit rate. To set a custom bit rate, select Custom and enter a value in the Custom Rate field.
Display Format	Sets the waveform view to show just the decoded bus information, or the decoded bus and the logical views of each constituent signal.
Decode Format	Sets the decode format used to display the bus information. Formats are Hex, Binary, and Mixed. Mixed format displays Payload/Data and Trailer/CRC bytes as hexadecimal values. Other fields are displayed in ASCII, decimal, or hexadecimal format.

Other bus types. Serial bus types, such as CAN, LIN, Ethernet, and so on, are available as purchasable options. Once purchased and installed, the new bus types are shown in the Bus Type menu. The serial bus options also add corresponding bus trigger capabilities to the **Trigger** menu.

Use the following links to access information on specific Bus configuration menus.

[Parallel Bus configuration menu](#) on page 149

[I2C serial bus configuration menu](#) on page 144

[SPI serial bus configuration menu](#) on page 153

[RS-232 serial bus menu](#) on page 151

[CAN serial bus configuration menu](#) on page 140

[LIN serial bus configuration menu](#) on page 146

[FlexRay serial bus configuration menu](#) on page 143

[Audio serial bus configuration menu](#) on page 138

[USB serial bus configuration menu](#) on page 155

[MIL-STD-1553 serial bus menu](#) on page 147

[ARINC429 serial bus menu](#) on page 136

See also.

[Bus Trigger configuration](#) on page 237

[Bus Search configuration menus](#) on page 159

I2C serial bus configuration menu

Use the I2C bus menu (optional) to set up and display an I²C (Inter-Integrated Circuit) serial bus waveform.

To set up the I²C serial bus menu:

- To create a new I²C bus waveform, tap the **Add Math Ref Bus** badge on the Settings bar and select **Bus**. Open the bus configuration menu by double clicking on the badge. Set the **Bus Type** to **I2C**.
- To change the settings on an existing I²C serial bus waveform, double-tap the I²C **Bus** waveform badge and make necessary changes in the configuration menu.

I2C serial bus menu fields and controls.

Field or control	Description
Display	Turns on or off displaying the bus in the Waveform view.
Label	Enter a label for the bus. The default label is the selected bus type. To enter label text, double-tap the field and enter label using the virtual keyboard, or tap the field and enter text from an attached keyboard.
Bus Type	Set to I2C .
SCLK Input	Sets the source and threshold level for the Serial Clock Line signal.
SDA Input	Sets the source and threshold level for the Serial Data signal.
Include R/W bit in Address	Select Yes to display 7-bit addresses as eight bits, where the eighth bit (LSB) is the R/W bit, or display 10-bit addresses as 11 bits, where the third bit is the R/W bit. Select No to display 7-bit addresses as seven bits, and 10-bit addresses as ten bits.
Display Format	Sets the waveform view to show just the decoded bus information, or the decoded bus and the logical views of each constituent signal.
Decode Format	Sets the decode format used to display the bus information. Formats are Hex and Binary.

Other bus types. Serial bus types, such as CAN, LIN, Ethernet, and so on, are available as purchasable options. Once purchased and installed, the new bus types are shown in the Bus Type menu. The serial bus options also add corresponding bus trigger capabilities to the **Trigger** menu.

Use the following links to access information on specific Bus configuration menus.

[Parallel Bus configuration menu](#) on page 149

[I2C serial bus configuration menu](#) on page 144

[SPI serial bus configuration menu](#) on page 153

[RS-232 serial bus menu](#) on page 151

[CAN serial bus configuration menu](#) on page 140

[LIN serial bus configuration menu](#) on page 146

[FlexRay serial bus configuration menu](#) on page 143

[Audio serial bus configuration menu](#) on page 138

[USB serial bus configuration menu](#) on page 155

[MIL-STD-1553 serial bus menu](#) on page 147

[ARINC429 serial bus menu](#) on page 136

See also.

Bus Trigger configuration on page 237

Bus Search configuration menus on page 159

LIN serial bus configuration menu

Use this menu (optional) to set up and display a LIN (Local Interconnect Network) serial bus waveform.

To set up the LIN serial bus:

- To create a new LIN bus waveform, tap the **Add Math Ref Bus** badge on the Settings bar and select **Bus**. Open the bus configuration menu by double clicking on the badge. Set the **Bus Type** to **LIN**.
- To change the settings on an existing LIN serial bus waveform, double-tap the LIN **Bus** waveform badge and make necessary changes.

LIN serial bus menu fields and controls.

Field or control	Description
Display	Turns on or off displaying the bus in the Waveform view.
Label	Enter a label for the bus. The default label is the selected bus type. To enter label text, double-tap the field and enter label using the virtual keyboard, or tap the field and enter text from an attached keyboard.
Bus Type	Set to LIN .
Source	Set the signal source from available analog or digital channels.
Threshold	Set the threshold level to define a logic high level.
Polarity	Select the polarity (Normal or Inverted) to match the LIN bus being acquired.
LIN Standard	Select the standard to match the LIN bus being acquired.
Bit rate	Sets the bit rate. To enter a custom bit rate, select Custom and enter the custom bit rate in the Custom Rate input box.
Include Parity Bits with ID	Set to Yes to include parity bits with the ID.
Sample Point	Sets the sample point from 5% to 95% of the position within the bit period or the unit interval.
Display Format	Sets the waveform view to show just the decoded bus information, or the decoded bus and the logical views of each constituent signal.
Decode Format	Sets the decode format used to display the bus information. Formats are Hex, Binary, and Mixed. Mixed displays the Frame Id and parity in decimal, and everything else is displayed in hexadecimal format.

Other bus types. Serial bus types, such as CAN, LIN, Ethernet, and so on, are available as purchasable options. Once purchased and installed, the new bus types are shown in the Bus Type menu. The serial bus options also add corresponding bus trigger capabilities to the **Trigger** menu.

Use the following links to access information on specific Bus configuration menus.

[Parallel Bus configuration menu](#) on page 149

[I2C serial bus configuration menu](#) on page 144

[SPI serial bus configuration menu](#) on page 153

[RS-232 serial bus menu](#) on page 151

[CAN serial bus configuration menu](#) on page 140

[LIN serial bus configuration menu](#) on page 146

[FlexRay serial bus configuration menu](#) on page 143

[Audio serial bus configuration menu](#) on page 138

[USB serial bus configuration menu](#) on page 155

[MIL-STD-1553 serial bus menu](#) on page 147

[ARINC429 serial bus menu](#) on page 136

See also.

[Bus Trigger configuration](#) on page 237

[Bus Search configuration menus](#) on page 159

MIL-STD-1553 serial bus menu

Use the MIL-STD-1553 bus menu (optional) to set up and decode a MIL-STD-1553 aeronautic network serial data bus waveform.

To set up the MIL-STD-1553 serial data bus:

- To create a new MIL-STD-1553 bus waveform, tap the **Add Math Ref Bus** button on the Settings bar and tap **Bus**. Open the bus configuration menu by double clicking on the badge. Set the **Bus Type** to **MIL-STD-1553**.
- To change the settings on an existing MIL-STD-1553 serial bus waveform, double-tap the **Bus** waveform badge and make necessary changes.

MIL-STD-1553 serial bus menu fields and controls.

Field or control	Description
Display	Turns on or off displaying the bus in the Waveform view.
Label	Enter a label for the bus. The default label is the selected bus type. To enter label text, double-tap the field and enter label using the virtual keyboard, or tap the field and enter text using an attached keyboard.
Bus Type	Set to MIL-STD-1553 .
Polarity	Select the polarity (Normal or Inverted) to match the MIL-STD-1553 bus being acquired.
Source	Select the MIL-STD-1553 signal source.
High Threshold, Low Threshold	Sets the valid high and low threshold values for the signal source.
RT Maximum	Sets the maximum valid response time (RT) for a command.
RT Minimum	Sets the minimum valid response time (RT) for a command.
Display Format	Sets the waveform view to show just the decoded bus information, or the decoded bus and the logical views of each constituent signal.
Decode Format	Sets the decode format used to display the bus information. Formats are Hex, Binary, Mixed ASCII, and Mixed Hex. Mixed ASCII displays data as ASCII, addresses as decimal, and binary bits. Mixed Hex displays data as hexadecimal, addresses and count as decimal, and binary bits.

Other bus types. Serial bus types, such as CAN, LIN, Ethernet, and so on, are available as purchasable options. Once purchased and installed, the new bus types are shown in the Bus Type menu. The serial bus options also add corresponding bus trigger capabilities to the **Trigger** menu.

Use the following links to access information on specific Bus configuration menus.

- [Parallel Bus configuration menu](#) on page 149
- [I2C serial bus configuration menu](#) on page 144
- [SPI serial bus configuration menu](#) on page 153
- [RS-232 serial bus menu](#) on page 151
- [CAN serial bus configuration menu](#) on page 140
- [LIN serial bus configuration menu](#) on page 146
- [FlexRay serial bus configuration menu](#) on page 143
- [Audio serial bus configuration menu](#) on page 138
- [USB serial bus configuration menu](#) on page 155
- [MIL-STD-1553 serial bus menu](#) on page 147
- [ARINC429 serial bus menu](#) on page 136

See also.

[Bus Trigger configuration](#) on page 237

[Bus Search configuration menus](#) on page 159

Parallel Bus configuration menu

Use this menu to set up and display a parallel bus waveform. Parallel bus decoding and triggering is included with the oscilloscope.

To set up the parallel bus:

- To create a new parallel bus, tap the **Add Math, Ref, Bus** button on the Settings bar and select **Bus**. Open the bus configuration menu by double clicking on the badge. Set the **Bus Type** to **Parallel**.
- To change the settings on an existing parallel bus waveform, double-tap the **Bus** waveform badge to open the configuration menu, and make necessary changes.

Parallel bus configuration menu fields and controls.

Field or control	Description
Display	Turns on or off displaying the bus in the Waveform view.
Label	Enter a label for the bus. The default label is the selected bus type. To enter label text, double-tap the field and enter label using the virtual keyboard, or tap the field and enter text from an attached keyboard.
Bus Type	Set to Parallel to define a parallel bus.
Clocked Data	Toggles Yes or No to use a clock signal to recover the data bits from the bus inputs.
Clock Source	Sets the source for the bus clock signal. The source can be an analog or digital channel. This field is only available when Clocked Data is set to Yes .
Clock Polarity	Sets the clock signal edge (rising, falling, or both) to use for timing reference. This field is only available when Clocked Data is set to Yes .
Threshold	Sets the threshold value to determine high logic value. This field is only available when Clocked Data is set to Yes .
Define Inputs	Opens a Parallel Bus - Define Inputs configuration menu to set the signal sources and the bit order (MSB to LSB) for the bus. See Parallel Bus - Define Inputs menu on page 150.
Display Format	Sets the waveform view to show just the decoded bus information, or the decoded bus and the logical views of each constituent signal.
Decode Format	Sets the decode format used to display the bus information. Formats are Hex and Binary.

Other bus types. Serial bus types, such as CAN, LIN, Ethernet, and so on, are available as purchasable options. Once purchased and installed, the new bus types are shown in the Bus Type menu. The serial bus options also add corresponding bus trigger capabilities to the **Trigger** menu.

Use the following links to access information on specific Bus configuration menus.

[Parallel Bus configuration menu](#) on page 149

[I2C serial bus configuration menu](#) on page 144

[SPI serial bus configuration menu](#) on page 153

[RS-232 serial bus menu](#) on page 151

[CAN serial bus configuration menu](#) on page 140

[LIN serial bus configuration menu](#) on page 146

[FlexRay serial bus configuration menu](#) on page 143

[Audio serial bus configuration menu](#) on page 138

[USB serial bus configuration menu](#) on page 155

[MIL-STD-1553 serial bus menu](#) on page 147

[ARINC429 serial bus menu](#) on page 136

See also.

[Bus Trigger configuration](#) on page 237

[Bus Search configuration menus](#) on page 159

Parallel Bus - Define Inputs menu

Use this menu to select the signal sources and order for the parallel bus waveform.

To access the Parallel Bus - Define Inputs menu, double-tap a Parallel Bus badge to open the configuration menu, and tap the **Define Inputs** button.

Parallel Bus - Define Inputs menu fields and controls.

Field or control	Description
Parallel bus definition list	<p>Lists the signal source and thresholds of selected channels or waveforms. The MSB is at the top of the list.</p> <p>To add a signal to the Parallel bus definition list, tap a source button in the Sources list. The button moves from the Sources list to the bottom of the bus list.</p> <p>Use the arrow buttons to the right of the field to move a selected signal up or down in the list.</p> <p>To remove a signal from the Parallel bus (and return it to the Sources list), tap on the signal source button.</p> <p>To change the threshold value for individual channels, tap in a selected Threshold field and use the assigned multipurpose knob, or double-tap the field to open the keypad and enter values.</p>
Sources	Lists all available sources to use for a parallel bus. To add a source to the Parallel bus definition list, tap a source button. The button moves from the Sources list to the bottom of the bus list.
Set All Thresholds	Sets all thresholds in the Parallel bus definition list to the specified value. Enter a value and tap Apply to set the values.

RS-232 serial bus menu

Use this menu (optional) to set up and display an RS232 serial bus waveform.

To set up a RS-232 serial bus:

- To create a new RS-232 bus waveform, tap the **Add Math Ref Bus** badge on the Settings bar and select **Bus**. Open the bus configuration menu by double clicking on the badge. Set the **Bus Type** to **RS-232**.
- To change the settings on an existing RS-232 serial bus waveform, double-tap the RS-232 **Bus** waveform badge to open the configuration menu and make necessary changes.

RS-232 serial bus menu fields and controls.

Field or control	Description
Display	Turns on or off displaying the bus in the Waveform view.
Label	Enter a label for the bus. The default label is the selected bus type. To enter label text, double-tap the field and enter label using the virtual keyboard, or tap the field and enter text from an attached keyboard.
Bus Type	Set to RS-232 .
Bit Rate	Sets the data bit rate. To enter a custom bit rate, select Custom and enter the custom bit rate in the Custom Rate input box.
Source	Set the signal source from available analog or digital channels.
Threshold	Set the threshold level to define a logic high level.
Polarity	Select the polarity (Normal or Inverted) to match the RS-232 bus being acquired. Use Normal polarity for RS-232 signals, and Inverted polarity for RS-422, RS-485, and UART buses.
Data Bits	Set the number of bits that define a data packet for your RS-232 bus.
Parity	Set the parity to match the RS-232 bus being acquired.
Packet View	Set to On to show decoded packet level information on the bus waveform.
End of packet	Select the appropriate end of packet value to match the RS-232 bus being acquired. Available when Packet View = On.
Display Format	Sets the waveform view to show just the decoded bus information, or the decoded bus and the logical views of each constituent signal.
Decode Format	Sets the decode format used to display the bus information. Formats are Hex, Binary, and ASCII.

Other bus types. Serial bus types, such as CAN, LIN, Ethernet, and so on, are available as purchasable options. Once purchased and installed, the new bus types are shown in the Bus Type menu. The serial bus options also add corresponding bus trigger capabilities to the **Trigger** menu.

Use the following links to access information on specific Bus configuration menus.

[Parallel Bus configuration menu](#) on page 149

[I2C serial bus configuration menu](#) on page 144

[SPI serial bus configuration menu](#) on page 153

[RS-232 serial bus menu](#) on page 151

[CAN serial bus configuration menu](#) on page 140

[LIN serial bus configuration menu](#) on page 146

[FlexRay serial bus configuration menu](#) on page 143

[Audio serial bus configuration menu](#) on page 138

[USB serial bus configuration menu](#) on page 155

[MIL-STD-1553 serial bus menu](#) on page 147

[ARINC429 serial bus menu](#) on page 136

See also.

[Bus Trigger configuration](#) on page 237

[Bus Search configuration menus](#) on page 159

SPI serial bus configuration menu

Use the SPI bus menu (optional) to set up and display an SPI (Serial Peripheral Interface) synchronous serial bus waveform.

To set up the SPI serial bus:

- To create a new SPI bus waveform, tap the **Add Math Ref Bus** badge on the Settings bar and select **Bus**. Open the bus configuration menu by double clicking on the badge. Set the **Bus Type** to **SPI**.
- To change the settings on an existing SPI serial bus waveform, double-tap the **Bus** waveform badge to open the configuration menu, and make necessary changes.

SPI serial bus menu fields and controls.

Field or control	Description
Display	Turns on or off displaying the bus in the Waveform view.
Label	Enter a label for the bus. The default label is the selected bus type. To enter label text, double-tap the field and enter label using the virtual keyboard, or tap the field and enter text from an attached keyboard.
Bus Type	Set to SPI .
Framing	Set to Slave Select (SS) or Idle framing modes.
SCLK Input	Select the channel source and threshold level for the Serial Clock signal (output from master). Set the Polarity to rising or falling edge of the clock signal used by the master device to start transferring bits.
SS Input	Select the channel source and threshold level for the Slave Select signal to start communications with the slave device. Set the Polarity to use Active High or Active Low logic for the SS signal. Available when Framing = SS.
MOSI Input	Select the channel source and threshold level for the Master Out Slave/In signal. Set the Polarity to use Active High or Active Low logic for the signal.
MISO Input	Select the channel source and threshold level for the Master In Slave/Out signal. Set the Polarity to use Active High or Active Low logic for the signal.
Word Size	Enter the word size, in bits. Common word sizes are 8, 16, and 32.
Bit Order	Set to most significant bit first (MS First) or least significant bit first (LS First).
Idle Time (Framing =)	Set the idle frame time. Available when Framing = Idle.
Display Format	Sets the waveform view to show just the decoded bus information, or the decoded bus and the logical views of each constituent signal.
Decode Format	Sets the decode format used to display the bus information. Formats are Hex and Binary.

Other bus types. Serial bus types, such as CAN, LIN, Ethernet, and so on, are available as purchasable options. Once purchased and installed, the new bus types are shown in the Bus Type menu. The serial bus options also add corresponding bus trigger capabilities to the **Trigger** menu.

Use the following links to access information on specific Bus configuration menus.

[Parallel Bus configuration menu](#) on page 149

[I2C serial bus configuration menu](#) on page 144

[SPI serial bus configuration menu](#) on page 153

[RS-232 serial bus menu](#) on page 151

[CAN serial bus configuration menu](#) on page 140

[LIN serial bus configuration menu](#) on page 146

[FlexRay serial bus configuration menu](#) on page 143

[Audio serial bus configuration menu](#) on page 138

[USB serial bus configuration menu](#) on page 155

[MIL-STD-1553 serial bus menu](#) on page 147

[ARINC429 serial bus menu](#) on page 136

See also.

[Bus Trigger configuration](#) on page 237

[Bus Search configuration menus](#) on page 159

USB serial bus configuration menu

Use the USB bus menu (optional) to set up and display an USB 2.0 (Universal Serial Bus) waveform.

To set up a USB serial bus:

- To create a new USB bus waveform, tap the **Add Math Ref Bus** badge on the Settings bar and select **Bus**. Open the bus configuration menu by double-clicking on the badge. Set the **Bus Type** to **USB**.
- To change the settings on an existing USB serial bus waveform, double-tap the **Bus** waveform badge on the Settings bar to open the configuration menu, and make necessary changes.

USB serial bus menu fields and controls.

Field or control	Description
Display	Turns on or off displaying the bus in the Waveform view.
Label	Enter a label for the bus. The default label is the selected bus type. To enter label text, double-tap the field and enter label using the virtual keyboard, or tap the field and enter text from an attached keyboard.
Bus Type	Set to USB .
Speed	Set the speed to match the USB bus you are acquiring.
Signal type	Set to match the USB signal you are acquiring (Single Ended or Differential). Use a differential probe to acquire the differential USB signal. Both Single Ended and Diff can be used to measure Full (12 Mbps) and Low (1.2 Mbps) speed USB signals.
Source	Select the channel source for the signal from a differential probe. This field is only available when Signal Type = Diff.
High Threshold	Set the high threshold level for the differential signal.
Low Threshold	Set the low threshold level for the differential signal.
D+ Input	Select the channel source and set the threshold level for the Data+ signal. This field is only available when Signal Type = Single Ended.
D- Input	Select the channel source and set the threshold level for the Data- signal. This field is only available when Signal Type = Single Ended.
Display Format	Sets the waveform view to show just the decoded bus information, or the decoded bus and the logical views of each constituent signal.
Decode Format	Sets the decode format used to display the bus information. Formats are Hex and Binary.

Other bus types. Serial bus types, such as CAN, LIN, Ethernet, and so on, are available as purchasable options. Once purchased and installed, the new bus types are shown in the Bus Type menu. The serial bus options also add corresponding bus trigger capabilities to the **Trigger** menu.

Use the following links to access information on specific Bus configuration menus.

[Parallel Bus configuration menu](#) on page 149

[I2C serial bus configuration menu](#) on page 144

[SPI serial bus configuration menu](#) on page 153

[RS-232 serial bus menu](#) on page 151

[CAN serial bus configuration menu](#) on page 140

[LIN serial bus configuration menu](#) on page 146

[FlexRay serial bus configuration menu](#) on page 143

[Audio serial bus configuration menu](#) on page 138

[USB serial bus configuration menu](#) on page 155

[MIL-STD-1553 serial bus menu](#) on page 147

[ARINC429 serial bus menu](#) on page 136

See also.

[Bus Trigger configuration](#) on page 237

[Bus Search configuration menus](#) on page 159

Add Results Table

Use the Results Table button to add a table of all active measurements, searches, bus decode values, and harmonics. Results tables show values in a spreadsheet-like format.

To add a result table to the screen:

1. Tap **Results Table**.
2. Tap **Measure**, **Bus1**, **Bus2**, **Search**, or **Harmonics** to select a table type. The content displayed depends on the selected tab.

Results Table menu fields and controls

Field or control	Description
Measurements	Display a table of all the measurements in the Results bar.
Bus 1	Display a table of the bus decode results.
Bus 2	Each row in the event table represents a time-stamped byte, packet, or word, depending on the bus type. As you scroll the event table using the multipurpose knob, the view point in the oscilloscope display updates to show the position in the waveform corresponding to the event in the Event Table.
Search	Display a table of all defined searches with each search shown on its own tab. The search mark table shows a time-stamped listing of each event.
Harmonics	Displays a table of the Harmonics measurement results (optional). Select between table view and bar graph view using the Harmonics tab.

- To save the results table, double-tap the results table and tap **Save Table** to open the Save As menu.
- To change the vertical size of the results table, tap the bottom border of the table and drag it to a new location.

Search configuration menu overview

Use the Search configuration menu to define conditions that you want to mark on a channel or waveform signal.

If there is no Search badge on the Results bar, tap the **Search** button. A Search badge is added to the Results bar, and the Search configuration menu opens to search type of Edge (default).

If there is a Search badge on the Results bar, double-tap the Search badge to open the Search configuration menu.

The search types and settings are similar to their corresponding trigger types (Edge, Pulse Width, Runt, and so on).

Each occurrence of the search condition is marked with a triangle along the top of the display.

Other search types

[Bus Search configuration menus](#) on page 159

[Edge Search configuration menu](#) on page 175

[Logic Search configuration menu](#) on page 177

[Pulse Width Search configuration menu](#) on page 180

[Rise/Fall Time Search configuration menu](#) on page 182

[Runt Search configuration menu](#) on page 184

[Setup and Hold Search configuration menu](#) on page 185

[Timeout Search configuration menu](#) on page 187

Bus Search configuration menus

Use a Bus search to search for and mark bus-related events (Start, Stop, Missing Acq, Address, Data, and so on) on a bus waveform.

To create a new Bus search:

1. Tap **Search**.
2. Set the **Search Type** to **Bus**.
3. Select the bus **Source**.
4. Use the search menu fields to set the search parameters.

To change the settings of an existing search, double-tap the search badge to open its configuration menu and make necessary changes.

Select a link to view the configuration menu settings for a specific bus.

[ARINC429 serial bus search configuration menu](#) on page 160

[Audio serial bus search configuration menu](#) on page 162

[CAN serial bus search configuration menu](#) on page 163

[FlexRay serial bus search configuration menu](#) on page 165

I2C serial bus search configuration menu on page 167

LIN serial bus search configuration menu on page 168

MIL-STD-1553 Search configuration menu on page 169

Parallel bus search configuration menu on page 171

RS-232 serial bus search configuration menu on page 172

SPI serial bus search configuration menu on page 173

USB serial bus search configuration menu on page 173

Other search types. *Edge Search configuration menu* on page 175

Logic Search configuration menu on page 177

Pulse Width Search configuration menu on page 180

Rise/Fall Time Search configuration menu on page 182

Runt Search configuration menu on page 184

Setup and Hold Search configuration menu on page 185

Timeout Search configuration menu on page 187

ARINC429 serial bus search configuration menu

Use the ARINC429 Search configuration menu to define conditions to search for and mark on an ARINC429 bus waveform.

NOTE. Requires option SRAERO.

Field or control	Description
Display	Enables or disables displaying search marks on this search.
Source	Select the ARINC429 bus to search.
Mark On	Sets the type of information for which to search.
Mark When	Sets the condition for which to search.
Label	<p>Sets the label pattern for which to search.</p> <p>Tap the Binary, Hex, or Octal field and use the A and B knobs to select and change the values. Or double-tap on the field and use the virtual keypad to enter values.</p> <p>Available when Mark When \neq Inside Range or Outside Range .</p>

Field or control	Description
Label Low	<p>Sets the low value of the label pattern range for which to search.</p> <p>Tap the Binary or Hex field and use the A and B knobs to select and change the values. Or double-tap on the field and use the virtual keypad to enter values.</p> <p>Available when Mark When = Label and Mark When Label = Inside Range or Outside Range.</p>
Label High	<p>Sets the high value of the label pattern range for which to search.</p> <p>Tap the Binary or Hex field and use the A and B knobs to select and change the values. Or double-tap on the field and use the virtual keypad to enter values.</p> <p>Available when Mark When = Label and Mark When Label = Inside Range or Outside Range.</p>
Mark When Data	<p>Sets the data condition for which to search.</p> <p>Available when Mark On = Label & Data or Data.</p>
Data	<p>Sets the data pattern for which to search.</p> <p>Tap the Binary, Hex, or Octal field and use the A and B knobs to select and change the values. Or double-tap on the field and use the virtual keypad to enter values.</p> <p>Available when Mark When Data \neq Inside Range or Outside Range.</p>
Data Low , Data High	<p>Sets the boundary data conditions when testing for in-range or out of range conditions.</p> <p>Tap the Binary or Hex field and use the A and B knobs to select and change the values. Or double-tap on the field and use the virtual keypad to enter values.</p> <p>Available when Mark When Data = Inside Range or Outside Range.</p>
SSM	<p>Sets the Sign/Status Matrix (SSM) bit condition for which to search.</p> <p>Tap the Binary or Hex field and use the A and B knobs to select and change the values. Or double-tap on the field and use the virtual keypad to enter values.</p> <p>Available when Mark On = Data and the Data Format control in the bus definition is set to Data (19 bits) or SDI + Data (21 bits).</p>

Field or control	Description
SDI	<p>Sets the Source/Destination Identifier (SDI) bit condition for which to search.</p> <p>Tap the Binary or Hex field and use the A and B knobs to select and change the values. Or double-tap on the field and use the virtual keypad to enter values.</p> <p>Available when Mark On = Data and the Data Format control in the bus definition is set to Data (19 bits).</p>
Error Type	<p>Sets the error condition for which to search:</p> <ul style="list-style-type: none"> ■ Any - This includes Parity, Word, and Gap errors ■ Parity - This error occurs if there are an even number of 1 bits, meaning that the word was corrupted during transmission. ■ Word - This error occurs if any part of the ARINC 429 format is violated; words must be 32 bits long and contain a parity bit at position 32 and label bits at positions 1-8. ■ Gap - This error occurs if there are less than 4 bit times of zero voltage between words. <p>Available when Mark On = Error.</p>
A, B knob controls	<p>Use the A knob to select (highlight) the digit(s) to change.</p> <p>Use the B knob to change the value of the digit(s).</p> <p>Or double-tap the field and use the virtual keypad to enter the data. See Binary, decimal, hex, and octal virtual keypads on page 274.</p>
Copy Trigger Settings to Search	<p>Sets the search criteria to match the current oscilloscope trigger settings. If the trigger settings are not valid in Search, this control is either not available or grayed out.</p>
Copy Search Settings to Trigger	<p>Sets the current oscilloscope trigger settings to match the search criteria.</p>

Audio serial bus search configuration menu

Use the Audio Search configuration menu to define conditions to search for and mark on an Audio bus waveform.

NOTE. Requires option *SRAUDIO*.

Field or control	Description
Display	Enables or disables displaying search marks on this search.
Source	Select the Audio bus to search.
Mark On	Select the type of information for which to search.

Field or control	Description
Data	<p>Sets the data pattern for which to search. Use in conjunction with the Mark When field to specify the exact search condition.</p> <p>Tap the Binary, Hex, or Decimal field and use the A and B knobs to select and change the values. Or double-tap on the field and use the virtual keypad to enter values.</p> <p>Only available when Mark On \neq Inside Range or Outside Range .</p>
Word	<p>Sets the audio word channel for which to search.</p> <p>Only available when Mark On = Data and the Audio bus is I2S, RJ, or LJ .</p>
Mark When	<p>Sets the mark when condition for the specified data pattern.</p> <p>When set to Inside Range or Outside Range, fields are displayed to set a high and low boundary pattern for the specified search range.</p> <p>Only available when Mark On = Data and the Audio bus is TDM .</p>
Data Low, Data High	<p>Sets the boundary data conditions when testing for in-range or out of range conditions.</p> <p>Available when Mark When is set to Inside Range or Outside Range.</p>
A, B knob controls	<p>Use the A knob to select (highlight) the digit(s) to change.</p> <p>Use the B knob to change the value of the digit(s). Or double-tap the field and use the virtual keypad to enter the data. See Binary, decimal, hex, and octal virtual keypads on page 274.</p>
Copy Trigger Settings to Search	<p>Sets the search criteria to match the current oscilloscope trigger settings. If the trigger settings are not valid in Search, this control is either not available or grayed out.</p>
Copy Search Settings to Trigger	<p>Sets the current oscilloscope trigger settings to match the search criteria.</p>

CAN serial bus search configuration menu

Use the CAN Search configuration menu to define conditions to search for and mark on a CAN bus waveform.

NOTE. Requires option *SRAUTO*.

Field or control	Description
Display	Enables or disables displaying search marks on this search.
Source	Select the CAN bus that you want to search.
Mark On	Select the type of information for which to search.
Frame Type	Sets the frame type for which to search.

Field or control	Description
BRS Bit	<p>Sets the BRS bit state for which to search.</p> <p>Only available when Mark On = FD BRS Bits.</p>
ESI Bit	<p>Sets the ESI bit state for which to search.</p> <p>Only available when Mark On = FD ESI Bits.</p>
Identifier Format	<p>Sets the identifier for Standard (11-bit) or Extended (29-bit for CAN 2.0B) length.</p> <p>Only available when Mark On = Identifier or ID & Data.</p>
Identifier	<p>Sets the identifier pattern for which to search. The number of bits shown depends on the Identifier Format setting.</p> <p>Tap the Binary or Hex field and use the A and B knobs to select and change the values. Or double-tap on the field and use the virtual keypad to enter values.</p> <p>Only available when Mark On = Identifier or ID & Data.</p>
Search When Data	<p>Sets the data to search for.</p> <p>Only available when Mark On = Identifier or ID & Data.</p>
Data Bytes	<p>Sets the number of data bytes for which to search (one to eight bytes). Use the A knob to change the value.</p> <p>Only available when Mark On = Data or Identifier & Data.</p>
Data Offset	<p>Sets the data offset in bytes to delay the trigger. Use the A knob to change the value.</p> <p>Only available when Mark On = Data or Identifier & Data.</p>
Data	<p>Sets the data pattern for which to search. The number of bits shown depends on the Data Bytes setting.</p> <p>Tap the Binary or Hex field and use the A and B knobs to select and change the values. Or double-tap on the field and use the virtual keypad to enter values.</p> <p>Only available when Mark On = Data or Identifier & Data.</p>
A, B knob controls	<p>Use the A knob to select (highlight) the digit to change.</p> <p>Use the B knob to change the value of the digit.</p> <p>Or double-tap the field and use the virtual keypad to enter the data. See Binary, decimal, hex, and octal virtual keypads on page 274.</p>
Copy Trigger Settings to Search	<p>Sets the search criteria to match the current oscilloscope trigger settings. If the trigger settings are not valid in Search, this control is either not available or grayed out.</p>
Copy Search Settings to Trigger	<p>Sets the current oscilloscope trigger settings to match the search criteria.</p>

FlexRay serial bus search configuration menu

Use the FlexRay Search configuration menu to define conditions to search for and mark on a FlexRay bus waveform.

NOTE. Requires option *SRAUTO*.

Field or control	Description
Display	Enables or disables displaying search marks on this search.
Source	Select the FlexRay bus for which to search.
Mark On	Select the type of information for which to search.
Indicator Bits	Select the defined indicator bits type for which to search from the drop-down list: Normal (01XX), Payload (11XX), Null (00XX), Sync (XX10), or Startup (XX11). Only available when Mark On = Indicator Bits .
Indicator Bits	Enter the indicator bits for which to search. Tap the Binary , Hex , or Decimal field and use the A and B knobs to select and change the values. Or double-tap on the field and use the virtual keypad to enter values. Only available when Mark On = Header Fields .
Identifier	Enter the frame identifier pattern for which to search. Tap the Binary , Hex , or Decimal field and use the A and B knobs to select and change the values. Or double-tap on the field and use the virtual keypad to enter values. Only available when Mark On = Identifier & Data or Header Fields .
Cycle Count	Enter the cycle count pattern for which to search. Use in conjunction with the Mark When field to specify the exact search condition. Tap the Binary , Hex , or Decimal field and use the A and B knobs to select and change the values. Or double-tap on the field and use the virtual keypad to enter values. Only available when Mark On = Cycle Count and Mark When Data is not set to Inside Range or Outside Range .
Payload Length	Enter the payload length pattern for which to search. Use in conjunction with the Mark On field to specify the exact search condition. Tap the Binary , Hex , or Decimal field and use the A and B knobs to select and change the values. Or double-tap on the field and use the virtual keypad to enter values. Only available when Mark On = Header Fields .

Field or control	Description
Header CRC	<p>Enter the header CRC pattern for which to search. Use in conjunction with the Mark On field to specify the exact search condition.</p> <p>Tap the Binary or Hex field and use the A and B knobs to select and change the values. Or double-tap on the field and use the virtual keypad to enter values.</p> <p>Only available when Mark On = Header Fields.</p>
Data Bytes	<p>Enter the number of data bytes for which to search (one to sixteen bytes). Use the A knob to change the value.</p> <p>Only available when Mark On = Data or Identifier & Data.</p>
Data	<p>Enter the data pattern for which to search. The number of bits shown depends on the Data Bytes setting. Use in conjunction with the Mark On field to specify the exact search condition.</p> <p>Tap the Binary or Hex field and use the A and B knobs to select and change the values. Or double-tap on the field and use the virtual keypad to enter values. See Binary, decimal, hex, and octal virtual keypads on page 274.</p> <p>Only available when Mark On = Data or Identifier & Data and Mark When Data is not set to Inside Range or Outside Range.</p>
Data Low, Data High	<p>Sets the boundary data conditions when testing for in-range or out of range conditions.</p> <p>Available when Mark On = Data or Identifier & Data and Mark When Data is set to Inside Range or Outside Range.</p>
Data Offset	<p>Sets the data offset (Don't Care or the number of bytes). Tap the field and use the A knob to change the value.</p> <p>Only available when Mark On = Data or Identifier & Data.</p>
Mark When	<p>Sets the mark when condition.</p> <p>When set to Inside Range or Outside Range, fields are displayed to set a high and low boundary pattern for the specified search range.</p> <p>Only available when Mark On = Identifier or Cycle Count.</p>
Frame Type	<p>Sets the end of frame type for which to search.</p> <p>Only available when Mark On = End of Frame.</p>
Error Type	<p>Sets the error type for which to search.</p> <p>Only available when Mark On = Error.</p>
A, B knob controls	<p>Use the A knob to select (highlight) the digit(s) to change.</p> <p>Use the B knob to change the value of the digit(s).</p> <p>Or double-tap the field and use the virtual keypad to enter the data. See Binary, decimal, hex, and octal virtual keypads on page 274.</p>

Field or control	Description
Copy Trigger Settings to Search	Sets the search criteria to match the current oscilloscope trigger settings. If the trigger settings are not valid in Search, this control is either not available or grayed out.
Copy Search Settings to Trigger	Sets the current oscilloscope trigger settings to match the search criteria.

I2C serial bus search configuration menu

Use the I2C Search configuration menu to define conditions to search for and mark on an I2C bus waveform.

NOTE. Requires option SREMBD.

Field or control	Description
Display	Enables or disables displaying search marks on this search.
Source	Select the I ² C bus that you want to search.
Mark On	Select the type of information for which to search.
Direction	Sets the transfer direction for which to search. Only available when Mark On = Address or Address & Data .
Addressing Mode	Sets the slave device address length (7 bits or 10 bits long). Only available when Mark On = Address or Address & Data .
Address	Sets the address pattern for which to search. The number of bits shown depends on the Address Mode setting. Tap the Binary or Hex field and use the A and B knobs to select and change the values. Or double-tap on the field and use the virtual keypad to enter values. Only available when Mark On = Address or Address & Data .
Data Bytes	Sets the number of data bytes for which to search (one to five bytes). Use the A knob to change the value. Only available when Mark On = Data or Address & Data .
Data	Sets the data pattern for which to search. The number of bits shown depends on the Data Bytes setting. Tap the Binary or Hex field and use the A and B knobs to select and change the values. Or double-tap on the field and use the virtual keypad to enter values. Only available when Mark When = Data or Address & Data .

Field or control	Description
A, B knob controls	Use the A knob to select (highlight) the character to change. Use the B knob to change the value of the character. Or double-tap the field and use the virtual keypad to enter the data. See Binary, decimal, hex, and octal virtual keypads on page 274.
Copy Trigger Settings to Search	Sets the search criteria to match the current oscilloscope trigger settings. If the trigger settings are not valid in Search, this control is either not available or grayed out.
Copy Search Settings to Trigger	Sets the current oscilloscope trigger settings to match the search criteria.

LIN serial bus search configuration menu

Use the LIN Search configuration menu to define conditions to search for and mark on an LIN bus waveform.

NOTE. Requires option *SRAUTO*.

Field or control	Description
Display	Enables or disables displaying search marks on this search.
Source	Select the LIN bus that you want to search.
Mark On	Select the type of information for which to search.
Identifier	Sets the identifier pattern for which to search. Tap the Binary , Hex , or Decimal field and use the A and B knobs to select and change the values. Or double-tap on the field and use the virtual keypad to enter values. Only available when Mark On = Identifier or Identifier & Data .
Data Bytes	Sets the number of data bytes for which to search (one to four bytes). Use the A knob to change the value. Only available when Mark On = Data or Identifier & Data .
Data	Sets the data pattern for which to search. The number of bits shown depends on the Data Bytes setting. Tap the Binary or Hex field and use the A and B knobs to select and change the values. Or double-tap on the field and use the virtual keypad to enter values. Only available when Mark On = Data or Identifier & Data .

Field or control	Description
Mark When Data	<p>Sets the mark when condition.</p> <p>When set to Inside Range or Outside Range, fields are displayed to set a Data Low and Data High boundary pattern for the specified search range.</p> <p>Only available when Mark On = Data or Identifier & Data.</p>
A, B knob controls	<p>Use the A knob to select (highlight) the digit(s) to change.</p> <p>Use the B knob to change the value of the digit(s).</p> <p>Or double-tap the field and use the virtual keypad to enter the data. See Binary, decimal, hex, and octal virtual keypads on page 274.</p>
Copy Trigger Settings to Search	Sets the search criteria to match the current oscilloscope trigger settings. If the trigger settings are not valid in Search, this control is either not available or grayed out.
Copy Search Settings to Trigger	Sets the current oscilloscope trigger settings to match the search criteria.

MIL-STD-1553 Search configuration menu

Use the MIL-STD-1553 Search configuration menu to define conditions to search for and mark on an MIL-STD-1553 bus waveform.

NOTE. Requires option *SRAERO*.

Field or control	Description
Display	Enables or disables displaying search marks on this search.
Source	Select the MIL-STD-1553 bus that you want to search.
Mark On	Select the type of information for which to search.
Transmit/Receive Bit	<p>Sets the transmit or receive bit state for which to search.</p> <p>Only available when Mark On = Command.</p>
Mark When	<p>Sets when to place a mark.</p> <p>When set to Inside Range or Outside Range, fields are displayed to set a high and low boundary pattern for the specified search range.</p> <p>Only available when Mark On = Time (RT/IMG).</p>
Maximum Time and Minimum Time	<p>Sets the high and low boundary for the specified search range.</p> <p>Only available when Mark On = Time (RT/IMG).</p>
Mark When RT Address	<p>Sets the RT address condition for which to search.</p> <p>When set to Inside Range or Outside Range, fields are displayed to set a low and high address for the specified search range.</p> <p>Only available when Mark On = Command or Status.</p>

Field or control	Description
Parity	<p>Sets the parity state for which to search.</p> <p>Only available when Mark On = Command or Status.</p>
Address	<p>Sets the address value for which to search.</p> <p>Tap the Binary, Hex, or Decimal field and use the A and B knobs to select and change the values. Or double-tap on the field and use the virtual keypad to enter values.</p> <p>Only available when Mark When RT Address \neq Inside Range or Outside Range.</p>
Low Address	<p>Sets the low address value for which to search.</p> <p>Tap the Binary, Hex, or Decimal field and use the A and B knobs to select and change the values. Or double-tap on the field and use the virtual keypad to enter values.</p> <p>Only available when Mark When RT Address = Inside Range or Outside Range.</p>
High Address	<p>Sets the high address value for which to search.</p> <p>Tap the Binary, Hex, or Decimal field and use the A and B knobs to select and change the values. Or double-tap on the field and use the virtual keypad to enter values.</p> <p>Only available when Mark When RT Address = Inside Range or Outside Range.</p>
Subaddress/Mode	<p>Sets the subaddress or mode value for which to search.</p> <p>Tap the Binary, Hex, or Decimal field and use the A and B knobs to select and change the values. Or double-tap on the field and use the virtual keypad to enter values.</p> <p>Only available when Mark On = Command.</p>
Word Count/Mode Code	<p>Sets the word count or mode count value for which to search.</p> <p>Tap the Binary, Hex, or Decimal field and use the A and B knobs to select and change the values. Or double-tap on the field and use the virtual keypad to enter values.</p> <p>Only available when Mark On = Command.</p>
Status Word Bits	<p>Sets the status word pattern for which to search.</p> <p>Tap the field and use the A and B knobs to select and change the values. Selecting a bit shows a short description of that bit's function.</p> <p>Only available when Mark On = Command.</p>

Field or control	Description
Data	<p>Sets the data pattern for which to search.</p> <p>Tap the Binary, Hex, or Decimal field and use the A and B knobs to select and change the values. Or double-tap on the field and use the virtual keypad to enter values.</p> <p>Available when Mark On = Data.</p>
Error Type	<p>Sets the error condition for which to search.</p> <p>Available when Mark On = Error.</p>
A, B knob controls	<p>Use the A knob to select (highlight) the digit(s) to change.</p> <p>Use the B knob to change the value of the digit(s).</p> <p>Or double-tap the field and use the virtual keypad to enter the data. See Binary, decimal, hex, and octal virtual keypads on page 274.</p>
Copy Trigger Settings to Search	<p>Sets the search criteria to match the current oscilloscope trigger settings. If the trigger settings are not valid in Search, this control is either not available or grayed out.</p>
Copy Search Settings to Trigger	<p>Sets the current oscilloscope trigger settings to match the search criteria.</p>

Parallel bus search configuration menu

Use the Parallel Search configuration menu to define conditions to search for and mark on an Parallel bus waveform. You can have multiple searches on the same bus.

NOTE. *Parallel bus search is standard on all instruments.*

Field or control	Description
Display	<p>Enables or disables displaying search marks on this search.</p>
Stop Acquisition if Event Found	<p>Stops input acquisition when the search event occurs. Default is not enabled.</p>
Source	<p>Select the parallel bus that you want to search.</p>
Data	<p>Sets the data pattern for which to search. The number of bits shown depends on how the parallel bus is defined.</p> <p>Tap the Binary or Hex field and use the A and B knobs to select and change the values. Or double-tap on the field and use the virtual keypad to enter values.</p>
A, B knob controls	<p>Use the A knob to select (highlight) the digit(s) to change.</p> <p>Use the B knob to change the value of the digit(s).</p> <p>Or double-tap the field and use the virtual keypad to enter the data. See Binary, decimal, hex, and octal virtual keypads on page 274.</p>

Field or control	Description
Copy Trigger Settings to Search	Sets the search criteria to match the current oscilloscope trigger settings. If the trigger settings are not valid in Search, this control is either not available or grayed out.
Copy Search Settings to Trigger	Sets the current oscilloscope trigger settings to match the search criteria.

RS-232 serial bus search configuration menu

Use the RS-232 Search configuration menu to define conditions to search for and mark on an RS-232 bus waveform. You can have multiple searches on the same bus.

NOTE. Requires option *SRCOMP*.

Field or control	Description
Display	Enables or disables displaying search marks on this search.
Source	Select the RS-232 bus that you want to search.
Mark On	Select the type of information for which to search.
Data Bytes	Sets the number of data bytes (1 byte = 8 bits) for which to search (one to ten bytes). Use the A knob to change the value. Only available when Mark On = Tx Data or Rx Data .
Data	Sets the data pattern for which to search. The number of bits shown depends on the Data Bytes setting. Tap the Binary or Hex field and use the A and B knobs to select and change the values. Or double-tap on the field and use the virtual keypad to enter values. Only available when Mark On = Tx Data or Rx Data .
A, B knob controls	Use the A knob to select (highlight) the digit(s) to change. Use the B knob to change the value of the digit(s). Or double-tap the field and use the virtual keypad to enter the data. See Binary, decimal, hex, and octal virtual keypads on page 274.
Copy Trigger Settings to Search	Sets the search criteria to match the current oscilloscope trigger settings. If the trigger settings are not valid in Search, this control is either not available or grayed out.
Copy Search Settings to Trigger	Sets the current oscilloscope trigger settings to match the search criteria.

SPI serial bus search configuration menu

Use the SPI Search configuration menu to define conditions to search for and mark on an SPI bus waveform.

NOTE. Requires option *SREMBD*.

Field or control	Description
Display	Enables or disables displaying search marks on this search.
Source	Select the SPI bus that you want to search.
Mark On	Select the type of information for which to search.
Data Bytes	Sets the number of data bytes (1 byte = 8 bits) for which to search (one to sixteen bytes). Use the A knob to change the value. Only available when Mark On = Data .
Data	Sets the data pattern for which to search. The number of bits shown depends on the Data Words setting. Tap the Binary or Hex field and use the A and B knobs to select and change the values. Or double-tap on the field and use the virtual keypad to enter values. Only available when Mark On = MOSI, MISO or MOSI & MISO .
A, B knob controls	Use the A knob to select (highlight) the digit(s) to change. Use the B knob to change the value of the digit(s). Or double-tap the field and use the virtual keypad to enter the data. See Binary, decimal, hex, and octal virtual keypads on page 274.
Copy Trigger Settings to Search	Sets the search criteria to match the current oscilloscope trigger settings. If the trigger settings are not valid in Search, this control is either not available or grayed out.
Copy Search Settings to Trigger	Sets the current oscilloscope trigger settings to match the search criteria.

USB serial bus search configuration menu

Use the USB Search configuration menu to define conditions to search for and mark on an USB bus waveform.

NOTE. Requires option *SRUSB2*.

Field or control	Description
Display	Enables or disables displaying search marks on this search.
Source	Select the USB bus that you want to search.
Mark On	Select the type of information for which to search.
Data Packet Type	Sets the special packet type for which to search. Only available when Mark On = Data Packet .

Field or control	Description
Address	<p>Sets the token packet address pattern for which to search. Use in conjunction with the Mark When field to specify the exact search condition.</p> <p>Tap the Binary, Hex, or Decimal field and use the A and B knobs to select and change the values. Or double-tap on the field and use the virtual keypad to enter values.</p> <p>Only available when Mark On \neq Inside Range or Outside Range.</p>
Token Type	<p>Sets the token packet type for which to search.</p> <p>Only available when Mark On = Token Packet.</p>
Endpoint	<p>Sets the token packet endpoint pattern for which to search. Use in conjunction with the Mark When field to specify the exact search condition.</p> <p>Tap the Binary, Hex, or Decimal field and use the A and B knobs to select and change the values. Or double-tap on the field and use the virtual keypad to enter values.</p> <p>Only available when Mark On = Token Packet and Token Type = all except SOF (0101).</p>
Frame Number	<p>Sets the frame number pattern for which to search. Use in conjunction with the Mark When field to specify the exact search condition.</p> <p>Tap the Binary, Hex, or Decimal field and use the A and B knobs to select and change the values. Or double-tap on the field and use the virtual keypad to enter values.</p> <p>Only available when Mark On = Token Packet and Token Type = SOF (0101).</p>
Data Packet Type	<p>Sets the data packet type for which to search.</p> <p>Only available when Mark On = Data Packet.</p>
Data Bytes	<p>Sets the number of data bytes for which to search (one to sixteen bytes). Tap the field and use the A knob to change the value.</p> <p>Only available when Mark On = Data Packet.</p>
Data Offset	<p>Sets the data offset (Don't Care or the number of bytes). Tap the field and use the A knob to change the value.</p> <p>Only available when Mark On = Data Packet.</p>

Field or control	Description
Data	<p>Sets the data packet pattern for which to search. The number of bits shown depends on the Data Bytes setting. Use in conjunction with the Mark When field to specify the exact search condition.</p> <p>Tap the Binary or Hex field and use the A and B knobs to select and change the values. Or double-tap on the field and use the virtual keypad to enter values.</p> <p>Only available when Mark On \neq Inside Range or Outside Range.</p>
Data Low, Data High	<p>Sets the boundary data conditions when testing for in-range or out of range conditions.</p> <p>Available when Mark When is set to Inside Range or Outside Range.</p>
Mark When	<p>Sets the mark when condition.</p> <p>When set to Inside Range or Outside Range, fields are displayed to set a high and low boundary pattern for the specified search range.</p> <p>Only available when Mark On = Handshake Packet, Error, Special Packet, Data Packet, or Token Packet and Token Type is set to anything but SOF (0101).</p>
A, B knob controls	<p>Use the A knob to select (highlight) the digit(s) to change.</p> <p>Use the B knob to change the value of the digit(s).</p> <p>Or double-tap the field and use the virtual keypad to enter the data. See Binary, decimal, hex, and octal virtual keypads on page 274.</p>
Copy Trigger Settings to Search	<p>Sets the search criteria to match the current oscilloscope trigger settings. If the trigger settings are not valid in Search, this control is either not available or grayed out.</p>
Copy Search Settings to Trigger	<p>Sets the current oscilloscope trigger settings to match the search criteria.</p>

Edge Search configuration menu

Use the Edge search to mark when the specified edge condition occurs on a waveform.

To create a new edge search:

1. Tap **Search**.
2. Set the **Search Type** to **Edge**.
3. Select the search **Source**.
4. Use the menu fields to set the search parameters.

To change the search settings, double-tap the search badge and make necessary changes.

Edge Search configuration menu fields and controls.

Field or control	Description
Display	Sets the display of the mark icons on or off.
Source	Lists the source channel or waveform to use to trigger or search. Types that require multiple inputs will replace this control with a different source definition control.
Coupling	Lists the coupling to use to trigger or search.
Level	Sets the amplitude level that the signal must pass through to be considered a valid transition.
Set to 50%	Sets the threshold at 50% of the measured signal transition range. 50% is calculated as (Top + Bottom)/2.
Slope	Sets the signal transition direction to detect. (rising, falling, or either direction).
Copy Trigger Settings to Search	Sets the search criteria to match the current oscilloscope trigger settings. If the trigger settings are not valid in Search, this control is either not available or grayed out.
Copy Search Settings to Trigger	Sets the current oscilloscope trigger settings to match the search criteria.

Other search types.

[Bus Search configuration menus](#) on page 159

[Logic Search configuration menu](#) on page 177

[Pulse Width Search configuration menu](#) on page 180

[Rise/Fall Time Search configuration menu](#) on page 182

[Runt Search configuration menu](#) on page 184

[Setup and Hold Search configuration menu](#) on page 185

[Timeout Search configuration menu](#) on page 187

**Logic Search
configuration menu**

Use the Logic search to mark when specified logic conditions occur on an analog, digital, math, or reference waveform.

To create a new logic search:

1. Tap **Search**.
2. Set the **Search Type** to **Logic**.
3. Use the menu fields to set the search parameters.

To change the settings on an existing search, double-tap the search badge and make necessary changes.

Logic Search configuration menu fields and controls.

Field or control	Description
Display	Sets the display of the mark icons on or off. If you have multiple searches defined, the control turns off just the marks for the selected search.
Search Type	Set to Logic .
Use Clock Edge?	Enables or disables finding logic patterns that occur on the specified clock edge. Yes places marks on the clock waveform wherever the logic pattern occurs. No places marks on the input signal waveform(s) wherever the logic pattern occurs.
Logic Pattern: Define Inputs	Opens the Logic Search-Define Inputs configuration menu where you define the logic state (High, Low, or Don't Care), and the signal threshold level that defines the logic state for each analog or digital signal. See Define Inputs .
Mark When	Defines the waveform logic event to mark, when Use Clock Edge is set to No. <ul style="list-style-type: none"> ■ Goes True: All conditions change to a true state. ■ Goes False: All conditions change to a false state. ■ Is True > Limit: Condition remains true longer than a specified time. ■ Is True < Limit: Condition remains true for less than a specified time. ■ Is True = Limit: Condition remains true for a specified time (within $\pm 5\%$). ■ Is True \neq Limit: Condition does not remain true for a specified time (within $\pm 5\%$).
Clock Source	Sets the signal to use as the clock. The clock source can be an analog, digital, math, or reference waveform.
Clock Edge	Sets the polarity of the clock edge (rising or falling) for evaluating the other menu conditions. The Logic menu also lets you set the clock edge to either edge.
Clock Threshold	Sets the threshold level that the clock signal must pass through to be considered a valid transition. The clock threshold value is independent of the input signal threshold(s).
Define Logic	Sets the logic condition that must occur with all inputs. <ul style="list-style-type: none"> ■ AND: All conditions are true. ■ OR: Any condition is true. ■ NAND: One or more conditions are true. ■ NOR: No conditions are true.

Field or control	Description
Copy Trigger Settings to Search	Sets the search criteria to match the current oscilloscope trigger settings. If the trigger settings are not valid in Search, this control is either not available or grayed out.
Copy Search Settings to Trigger	Sets the current oscilloscope trigger settings to match the search criteria.

Other search types.

[Bus Search configuration menus](#) on page 159

[Edge Search configuration menu](#) on page 175

[Pulse Width Search configuration menu](#) on page 180

[Rise/Fall Time Search configuration menu](#) on page 182

[Runt Search configuration menu](#) on page 184

[Setup and Hold Search configuration menu](#) on page 185

[Timeout Search configuration menu](#) on page 187

Logic Search - Define Inputs configuration menu

Use the Define Inputs menu to select the logic condition to search on, and the logic threshold value, for each channel.

To open the Logic Search-Define Inputs configuration menu:

1. Double-tap the **Logic Search** badge on the Settings bar.
2. Tap the **Logic Pattern > Define Inputs** invoker button.

Logic Search - Define Inputs configuration menu fields and controls.

Field or control	Description
Ch(x) (analog channels) or D(x) (digital Channels)	<p>Use to select the logic condition, of the signal source, on which to perform the logic search (High, Low, Don't Care).</p> <p>If a channel is a digital channel, tap the + symbol to open the list of digital inputs (D15-D8 or D7-D0) from which to select individual logic conditions for the digital signals.</p> <p>Use the Threshold field to set the signal level that must be exceeded for that signal to be true (logical 1).</p>
Set All	Sets all signal sources to detect a logic High, Low, or Don't Care condition.

Pulse Width Search configuration menu

Use the Pulse Width search to mark a waveform whenever the specified pulse width condition occurs.

To create a new pulse width search:

1. Tap **Search**.
2. Set the **Search Type** to **Pulse Width**.
3. Select the search **Source**.
4. Use the menu fields to set the search parameters.

To change the settings on an existing search, double-tap the search badge and make necessary changes.

Pulse Width Search menu fields and controls.

Field or control	Description
Display	Sets the display of the mark icons on or off.
Search Type	Set to Pulse Width .
Source	Lists the source channel or waveform to use to trigger or search. Types that require multiple inputs will replace this control with a different source definition control.
Mark When	<ul style="list-style-type: none"> ■ < Limit: A pulse width is less than the specified time limit. ■ > Limit: A pulse width is greater than the specified time limit. ■ = Limit: A pulse width is equal to the specified time limit. ■ ≠ Limit: A pulse width does not equal (is greater than or less than) the specified time limit. ■ Inside Range: A pulse width is in the specified time range. ■ Outside Range: A pulse width is outside of the specified time range.
Level	Sets the amplitude level that the signal must pass through to be considered a valid transition.
Set to 50%	Sets the threshold at 50% of the measured signal transition range. 50% is calculated as (Top + Bottom)/2.
Time Limit	Sets the time period condition to be met.
High Time Limit	<p>Sets the longest acceptable pulse width time period for the range condition.</p> <p>Only available when Mark When = Inside Range or Outside Range.</p>
Low Time Limit	<p>Sets the shortest acceptable pulse width time period for the range condition.</p> <p>Only available when Mark When = Inside Range or Outside Range.</p>
Polarity	Sets the polarity of the pulse to detect (positive pulse only, negative pulse only, or a positive or negative pulse).
Copy Trigger Settings to Search	Sets the search criteria to match the current oscilloscope trigger settings. If the trigger settings are not valid in Search, this control is either not available or grayed out.
Copy Search Settings to Trigger	Sets the current oscilloscope trigger settings to match the search criteria.

Other search types.

Bus Search configuration menu on page 159

Edge Search configuration menu on page 175

Logic Search configuration menu on page 177

Rise/Fall Time Search configuration menu on page 182

Runt Search configuration menu on page 184

Setup and Hold Search configuration menu on page 185

Timeout Search configuration menu on page 187

**Rise/Fall Time Search
configuration menu**

Use the Rise/Fall Time search to mark occurrences where the rise or fall time is less than, greater than, equal to, or not equal to a specified time limit.

To create a new rise/fall time search:

1. Tap **Search**.
2. Set the **Search Type** to **Rise/Fall Time**.
3. Select the search **Source**.
4. Use the menu fields to set the search parameters.

To change the settings on an existing search, double-tap the search badge and make necessary changes.

Rise/Fall Time Search configuration menu fields and controls.

Field or control	Description
Display	Sets the display of the mark icons on or off.
Search Type	Set to Rise/Fall Time .
Source	Lists the source channel or waveform to use to trigger or search. Types that require multiple inputs will replace this control with a different source definition control.
Mark When	<ul style="list-style-type: none"> ■ < Limit: A signal has a rise/fall time less than the specified time limit. ■ > Limit: A signal has a rise/fall time greater than the specified time limit. ■ = Limit: A signal has a rise/fall time that is equal to the specified time limit ($\pm 5\%$). ■ \neq Limit: A signal has a rise/fall time that does not equal (is greater than or less than) the specified time limit ($\pm 5\%$).
Time Limit	Sets the time period condition to be met.
Slope	Sets the signal transition direction to detect. (rising, falling, or either direction).
Upper Threshold	Sets the upper amplitude level through which the signal must pass to be considered a valid transition.
Lower Threshold	Sets the lower amplitude level through which the signal must pass to be considered a valid transition.
Copy Trigger Settings to Search	Sets the search criteria to match the current oscilloscope trigger settings. If the trigger settings are not valid in Search, this control is either not available or grayed out.
Copy Search Settings to Trigger	Sets the current oscilloscope trigger settings to match the search criteria.

Other search types.

[Bus Search configuration menus](#) on page 159

[Edge Search configuration menu](#) on page 175

[Logic Search configuration menu](#) on page 177

[Pulse Width Search configuration menu](#) on page 180

[Runt Search configuration menu](#) on page 184

[Setup and Hold Search configuration menu](#) on page 185

[Timeout Search configuration menu](#) on page 187

Runt Search configuration menu

Use the Runt search to mark a waveform where a pulse crosses one threshold but fails to cross a second threshold before recrossing the first threshold.

To create a new runt search:

1. Tap **Search**.
2. Set the **Search Type** to **Runt**.
3. Select the search **Source**.
4. Use the menu fields to set the search parameters.

To change the settings on an existing search, double-tap the search badge and make necessary changes.

Runt Search configuration menu fields and controls.

Field or control	Description
Display	Sets the display of the mark icons on or off.
Search Type	Set to Runt .
Source	Lists the source channel or waveform to use to trigger or search. Types that require multiple inputs will replace this control with a different source definition control.
Mark When	<ul style="list-style-type: none"> ■ Occurs: A runt signal event occurs. ■ < Limit: A runt signal event occurs that has a pulse width less than the specified time limit. ■ > Limit: A runt signal event occurs that has a pulse width greater than the specified time limit. ■ = Limit: A runt signal event occurs that has a pulse width that is equal to the specified time limit ($\pm 5\%$). ■ \neq Limit: A runt signal event occurs that has a pulse width that does not equal (is greater than or less than) the specified time limit ($\pm 5\%$).
Time Limit	<p>Sets the time period condition to be met.</p> <p>Only available when Mark When = < Limit, > Limit, = Limit, or != Limit.</p>
Polarity	Sets the polarity of the pulse to detect (positive pulse only, negative pulse only, or a positive or negative pulse).
Upper Threshold	Sets the upper amplitude level through which the signal must pass to be considered a valid transition.
Lower Threshold	Sets the lower amplitude level through which the signal must pass to be considered a valid transition.
Copy Trigger Settings to Search	Sets the search criteria to match the current oscilloscope trigger settings. If the trigger settings are not valid in Search, this control is either not available or grayed out.
Copy Search Settings to Trigger	Sets the current oscilloscope trigger settings to match the search criteria.

Other search types.

Bus Search configuration menus on page 159

Edge Search configuration menu on page 175

Logic Search configuration menu on page 177

Pulse Width Search configuration menu on page 180

Rise/Fall Time Search configuration menu on page 182

Setup and Hold Search configuration menu on page 185

Timeout Search configuration menu on page 187

**Setup and Hold Search
configuration menu**

Use the Setup and Hold search type to mark a waveform when a data signal changes state inside of a specified setup and hold time, relative to a specified clock signal.

To create a new setup and hold search:

1. Tap **Search**.
2. Set the **Search Type** to **Setup & Hold**.
3. Select the search **Clock Source**.
4. Use the menu fields to set the search parameters.

To change the settings on an existing search, double-tap the search badge and make necessary changes.

Setup & Hold Search configuration menu fields and controls.

Field or control	Description
Display	Sets the display of the mark icons on or off.
Search Type	Set to Setup & Hold .
Clock Source	Sets the signal to use as the clock. The clock source can be an analog, digital, math, or reference waveform.
Clock Threshold	Sets the threshold level that the clock signal must pass through to be considered a valid transition. The clock threshold value is independent of the input signal threshold(s).
Clock Edge	Sets the polarity of the clock edge (rising or falling) for evaluating the other menu conditions. The Logic menu also lets you set the clock edge to either edge.
Data Sources	Sets the data signal source(s). All selected sources must meet the specified setup and hold times. See Setup and Hold Search - Define Inputs configuration menu on page 187.
Setup Time	Sets the length of time that data signal should be stable and not change before a clock edge occurs.
Hold Time	Sets the length of time that data signal should be stable and not change after a clock edge occurs.
Copy Trigger Settings to Search	Sets the search criteria to match the current oscilloscope trigger settings. If the trigger settings are not valid in Search, this control is either not available or grayed out.
Copy Search Settings to Trigger	Sets the current oscilloscope trigger settings to match the search criteria.

Other search types.

[Bus Search configuration menus](#) on page 159

[Edge Search configuration menu](#) on page 175

[Logic Search configuration menu](#) on page 177

[Pulse Width Search configuration menu](#) on page 180

[Rise/Fall Time Search configuration menu](#) on page 182

[Runt Search configuration menu](#) on page 184

[Timeout Search configuration menu](#) on page 187

Setup and Hold Search - Define Inputs configuration menu

Use the Define Inputs menu to select the data signal source(s) and set their threshold level(s).

To open the Setup & Hold Search - Define Inputs menu:

1. Double-tap a **Setup & Hold Search** badge on the Results bar.
2. Tap the **Data Sources > Define Inputs** button.

Setup and Hold Search - Define Inputs configuration menu fields and controls.

Field or control	Description
Ch(x) (analog channels) or D(x) (digital Channels)	<p>Use to add (Include) or exclude (Don't Include) the data signal(s) from available input channels and waveforms.</p> <p>If a channel is a digital channel, tap the + symbol to open the list of digital inputs (D15-D8 or D0-D7) from which to select for that channel.</p> <p>Use the Threshold fields to set the signal level that must be exceeded for the signal transition to be true.</p>
Set All	Use to Include or Don't Include all available channels and waveforms as data signals.

Timeout Search configuration menu

Use the Timeout search to mark a waveform when it does not detect an expected pulse transition within a specified period of time, such as when a signal gets stuck either high or low.

To create a new timeout search:

1. Tap **Search**.
2. Set the **Search Type** to **Timeout**.
3. Select the search **Source**.
4. Use the menu fields to set the search parameters.

To change the settings on an existing search, double-tap the search badge and make necessary changes.

Timeout Search menu fields and controls.

Field or control	Description
Display	Sets the display of the mark icons on or off. If you have multiple searches defined, the control turns off just the marks for the selected search. Sets the display of the mark icons on or off.
Search Type	Set to Timeout .
Source	Lists the source channel or waveform to use to trigger or search. Types that require multiple inputs will replace this control with a different source definition control.
Mark When	<ul style="list-style-type: none"> ■ Stays High: The signal stays above the specified threshold level longer than the specified time. ■ Stays Low: The signal stays below the specified threshold level longer than the specified time. ■ Either: The signal stays above or below the specified threshold level longer than the specified time.
Threshold	Sets the amplitude level that the signal must pass through to be considered a valid transition.
Set to 50%	Sets the threshold at 50% of the measured signal transition range. 50% is calculated as $(\text{Top} + \text{Bottom})/2$.
Time Limit	Sets the time period condition to be met.
Copy Trigger Settings to Search	Sets the search criteria to match the current oscilloscope trigger settings. If the trigger settings are not valid in Search, this control is either not available or grayed out.
Copy Search Settings to Trigger	Sets the current oscilloscope trigger settings to match the search criteria.

Other search types.

[Bus Search configuration menus](#) on page 159

[Edge Search configuration menu](#) on page 175

[Logic Search configuration menu](#) on page 177

[Pulse Width Search configuration menu](#) on page 180

[Rise/Fall Time Search configuration menu](#) on page 182

[Runt Search configuration menu](#) on page 184

[Setup and Hold Search configuration menu](#) on page 185

Analog Channel configuration menu

Use the Analog Channel configuration menu to set up analog channel vertical settings, probe settings, deskew settings, external attenuation, and alternate units for analog channel inputs.

To open an analog channel configuration menu, double-tap an analog channel badge. The following text describes analog channel settings. For digital channel settings, see [Digital channel configuration menu](#) on page 203.

Vertical Settings panel, fields and controls

Field or control	Description
Display	Toggles display of the channel On and Off.
Invert	Toggles invert of the channel On and Off. Default is off.
Vertical Scale	Set the scale using the multipurpose knob, double-tap to bring up the virtual keypad, or tap the up and down arrows to change the scale.
Offset	Set the offset using the virtual keypad.
Set to 0	Sets the offset to 0.
Position	Set the vertical position using the virtual keypad.
Set to 0	Sets the waveform zero volt level to the center of the waveform view.
Label	Add a label to the channel display using the virtual keypad.
Bandwidth Limit	Select the bandwidth limit from the drop-down list. Lower bandwidth limits noise and can provide a cleaner view of the signal. Bandwidth is shown in the channel badge and a BW icon indicates that the bandwidth of the channel is lower than it theoretically could be due to a user setting or the attached probe.
Coupling	Sets the input coupling to DC or AC: <ul style="list-style-type: none"> ■ DC coupling passes all input signals to the input channel. ■ AC coupling passes the input signals above 60 Hz to the input channel.
Termination	Sets the input termination to 1 M Ω or 50 Ω . If you are using a supported TPP probe, this value is automatically set by the probe and these controls are not available.
Probe Setup	Use to see probe information, check the probe compensation status, compensate the probe, or restore the factory defaults <p>See Probe Setup panel (Channel configuration menu) on page 190.</p> <p>See Probe Compensation configuration menu (analog channels Probe Setup panel) on page 191.</p>
Other	Use to adjust signal delay to align signal arrival at the oscilloscope between probes and/or cables, set external attenuation, and set alternate units. <p>See Other panel (Channel configuration menu) on page 191.</p>

**Probe Setup panel
(Channel configuration
menu)**

Use the Channel configuration menu Probe Setup panel to see probe information, check the probe compensation status, compensate the probe, or restore the factory defaults.

To open the Probe Setup panel:

1. Double-tap an analog Channel badge on the Settings bar to open the Channel configuration menu.
2. Tap the **Probe Setup** panel.

Probe Setup panel fields and controls. Available fields and controls vary with the type of probe that is attached. For more information, consult the probe documentation.

Field or control	Description
Probe Information	View probe information such as probe type, serial number, version, propagation delay, and its attenuation.
Probe Compensation Status	View the probe compensation status: Default, Pass, Running, or Fail.
Compensate Probe	Displays the probe compensation dialog. This is only available for probes that support automatic compensation.
Restore Factory Defaults	Delete the stored compensation values for this probe and channel combination and restore the factory defaults. This is only available for probes that support automatic compensation.

Probe error messages are also displayed in this setup panel, see [Error messages and badges](#) on page 47.

See also.

[Probe Compensation configuration menu \(analog channels Probe Setup panel\)](#) on page 191

[Other panel \(Channel configuration menu\)](#) on page 191

[Deskew configuration menu \(Other panel Channel configuration menu\)](#) on page 192

Probe Compensation configuration menu (analog channels Probe Setup panel)

Use this menu to compensate probes that support automatic frequency compensation. This menu is only available when a compensation-supported probe is installed on the channel.

To open the Probe Compensation dialog:

1. Double-tap the Channel badge on the Settings bar to open the channel configuration menu.
2. Tap the **Probe Setup** panel.
3. Tap **Compensate Probe**.

Probe Compensation dialog. Available fields and controls vary with the type of probe that is attached. For more information, consult the probe documentation. Read the information on the menu before starting the probe compensation process.

Field or control	Description
Compensate Probe	Compensates the attached probe. Before compensating the probe, read the instructions in the dialog.
Restore Factory Defaults	Restores the probe compensation factory defaults and removes the previous compensation results.
Probe Compensation Status	Probe compensation status can be Running, Passed, Failed or Default.

See also.

Other panel (Channel configuration menu) on page 191

Deskew configuration menu (Other panel Channel configuration menu) on page 192

Other panel (Channel configuration menu)

Use the Other panel to set the channel deskew, external attenuation, and alternate vertical scale units.

To open the analog Channel configuration menu Other panel:

1. Double-tap an analog Channel badge on the Settings bar to open the Channel configuration menu.
2. Tap the **Other** panel.

Other panel fields and controls.

Field or control	Description
Deskew	Sets or displays the probe deskew value. Use Deskew to make display and measurement adjustments for probes that have differing propagation delays. This is especially important when using a current probe in conjunction with a voltage probe.
Set to 0	Sets the probe deskew value to zero (0) seconds.
Multi-Channel	Opens a Deskew configuration menu that allows you to deskew multiple channels (two at a time).
External Attenuation	Double-tap the numeric fields to set the external attenuation using the virtual keypad. Use this control to set the input/output ratio of any external attenuation or gain between the signal and input channels.
Probe type	Selects the probe type.
Measure Current	Toggles between Yes and No. This control is only visible when Probe Type is set to Voltage.
Ratio	Sets the ratio using the virtual keypad. These fields show the conversion from volts to amps and amps to volts. As you change one, the other changes as well. This control is only present when Measure Current is set to Yes .
Set to Unity	Sets the external attenuation ratio to unity. Only shown when Alternate Units = On .

See also.

[Probe Compensation configuration menu \(analog channels Probe Setup panel\)](#) on page 191

[Deskew configuration menu \(Other panel Channel configuration menu\)](#) on page 192

Deskew configuration menu (Other panel Channel configuration menu)

Use the Deskew configuration menu to make display and measurement adjustments for analog probes that have differing propagation delays. This is especially important when using a current probe in conjunction with a voltage probe for power measurements.

To open the Deskew configuration menu:

1. Double-tap an analog Channel badge on the Settings bar to open the Channel configuration menu.
2. Tap the **Other** panel.
3. Tap the **Multi-Channel** button.

Use the controls in the Deskew menu to set the deskew parameters to recommended values, based on the nominal propagation delay of supported probes. The oscilloscope automatically loads the nominal propagation delay values of TPP probes (TekProbe II probes require use of a TPA-BNC adaptor).

NOTE. This deskew menu does not actively test and adjust the probe delay between channels; it uses the delay values stored in supported probes, or a custom propagation delay value that you enter, to set the propagation delay to zero between the reference channel probe and one or more other probes.

To actively adjust probe delay using a signal, see [Deskew analog input channels - quick visual method](#) on page 63 and [Deskew analog input channels - measurement method](#) on page 64.

Deskew menu fields and controls. Available fields and controls vary with the type of probe that is attached. For more information, consult the probe documentation.

Field or control	Description
From Source	Select from the drop-down list the channel to deskew from (your reference channel for deskewing).
To Source	Select from the drop-down list the channel to deskew to (the channel that you want to match the From Source reference channel).
Probe	<p>If the oscilloscope recognizes the probe attached to the channel, the Probe field shows the nomenclature of the attached probe.</p> <p>If the oscilloscope does not recognize the probe attached to the channel, the Probe field shows a drop-down list from which you can select the probe that is attached to the selected channel.</p> <p>If the attached probe is not in the list, select Custom (at the bottom of the list) and enter the probe propagation delay in the Propagation Delay field.</p>
Propagation Delay	This field lists the default propagation delay of the attached probe. A positive value shifts a channel to the left.
OK, deskew	Sets the oscilloscope to add or subtract the delay values of the To Source channel such that the delay between the two channels is as close to 0 as possible.

See also.

[Probe Compensation configuration menu \(analog channels Probe Setup panel\)](#) on page 191

[Other panel \(Channel configuration menu\)](#) on page 191

[Deskew analog input channels - measurement method](#) on page 64

[Deskew analog input channels - quick visual method](#) on page 63

AFG configuration menu

Use the AFG configuration menu to set the output signal parameters for the optional arbitrary/function generator. Use the AFG to simulate signals within a design or add noise to signals to perform margin testing.

To open the AFG configuration menu:

1. If Off, tap the **AFG** button on the Settings bar. When Output is set to On, the oscilloscope changes the AFG button to an AFG badge that shows the AFG settings.
2. If On, double-tap the AFG badge to open the AFG menu.

Arbitrary/Function Generator overview

The function generator provides output of predefined waveforms up to 50 MHz. Choose between Sine, Square, Pulse, Ramp, DC, Noise, Sin(x)/x, Gaussian, Lorentz, Exponential Rise, Exponential Decay, Haversine, Cardiac and Arbitrary signals. The function generator also supports AM/FM modulation.

You can select a predefined waveform or load a saved .wfm- or .csv-format waveform from storage (USB drive).

Arbitrary/Function Generator Output menu fields and controls

Not all items listed in the table may be shown for all waveform types. The configuration menu only shows fields and controls relevant to the selected Waveform Type.

The output connector is on the rear panel, labeled AFG Out.

NOTE. *The AFG output is turned off when setups or sessions are recalled even if they were saved with the AFG on.*

Field or control	Description
Output	Toggles the output On or Off.
Waveform Type	Tap to select an available waveform from the list. Waveform types include: Sine, Square, Pulse, Ramp, DC, Noise, Sin(x)/x, Gaussian, Lorentz, Exponential Rise, Exponential Decay, Haversine, Cardiac, and Arbitrary.

Field or control	Description
Load From	<p>Select the source of the waveform from the drop-down list. Navigate to and select a waveform file to load into the AFG memory. Choose from the following locations (Channel 1 is the default location):</p> <ul style="list-style-type: none"> ■ Active analog channels ■ Active digital channels ■ Active math waveforms ■ Active reference waveforms ■ Arb memory locations ■ File <p>Only shown when Waveform Type = Arbitrary.</p>
Waveform File	Shows the loaded waveform file path and name. Tap to select a waveform file to load into the AFG waveform memory from the drop-down list of the last 20 waveforms that have been loaded using the Load button.
Symmetry	<p>Sets the symmetry of the ramp using the keypad or multipurpose knob.</p> <p>Only shown when the Waveform Type = Ramp.</p>
Width	<p>Sets the width of the pulse using the keypad or multipurpose knob.</p> <p>Only shown when the Waveform Type = Pulse.</p>
Duty Cycle	<p>Sets the duty cycle of the square wave using the keypad or multipurpose knob.</p> <p>Only shown when the Waveform Type = Square.</p>
Frequency	Sets the frequency of the waveform using the keypad or multipurpose knob. The frequency range is 0.1 Hz to 50 MHz, in increments of 0.1 Hz.
Period	Sets the period of the waveform using the keypad or multipurpose knob.
Amplitude	Sets the amplitude of the waveform using the keypad or multipurpose knob.
Offset	Sets the offset of the waveform using the keypad or multipurpose knob.
High Level	Sets the High signal amplitude of the waveform using the keypad or multipurpose knob.
Low Level	Sets the low signal amplitude of the waveform using the keypad or multipurpose knob.
Load Impedance	<p>Selects either 50 Ω or High Z (1 MΩ) output load impedance. Load impedance scales the vertical settings to show what the load would see based on the load impedance. Since the AFG is a 50 Ω source, for most accurate operation, set the load impedance to 50 Ω and set the input channel to 50 Ω.</p>
Add Noise	<p>Toggles noise on and off. Set the amount of noise to add to the output signal using the keypad or the multipurpose controls.</p> <p>When Modulation is on, Add Noise is not available.</p>

Field or control	Description
OK, Load Waveform	Loads the selected waveform.
Browse	Browse to the desired waveform.
Save Waveform	Opens a Save As menu for saving AFG waveforms to internal waveform slots or to an external file location.

Modulation menu fields and controls

NOTE. *The modulation menu is not available when the **Waveform Type** is set to DC, Pulse, Noise, or Cardiac.*

Field or control	Description
Modulation	Toggles the modulation On or Off.
Modulation Type	Toggle between AM or FM modulation. The default modulation is AM.
Frequency	Sets the frequency of the modulation using the keypad or multipurpose knob.
Modulation Shape	Select the modulation shape from the drop-down list. <ul style="list-style-type: none"> ■ Sine ■ Square ■ Triangle ■ Up Ramp ■ Down Ramp ■ Noise
Depth	Sets the depth of the modulation using the keypad or multipurpose knob. Only shown when the Modulation Type = AM.
Deviation	Sets the deviation of the modulation using the keypad or multipurpose knob. Only shown when the Modulation Type = FM.

Save As configuration menu (AFG menu)

Use this menu to configure saving AFG waveforms.

To access the **Save As** configuration menu, tap **AFG** on the global settings bar and tap **Save Waveform**.

Save As configuration menu fields and controls

The following fields and controls are available.

Field or control	Description
File navigation pane	<p>Lists the location where the file will be saved. The default value is the last location to which a file was saved. Navigate to and select the location to which to save the file.</p> <p>Use the + and - buttons to navigate the file directory.</p> <p>The - button closes the folder.</p> <p>The + button opens a folder.</p> <p>Removable media devices indicate their remaining free space in the title of the device.</p> <p>The size of individual files is indicated in the Size column.</p> <p>The date and time of the last modification to files and folders is displayed in the Date Modified column.</p>
File Name	<p>The file name assigned to the file. The default value is either the user-entered name used to last save this file type, or a numeric value calculated by the instrument. The default value is Tek000.</p> <p>Tap on the file name and use a keyboard to enter a new file name. Or double-tap on the file name to open the virtual keyboard and enter a file name.</p>
Format	<p>Lists the available formats to which you can save files. The available save formats are set by the type of file being saved.</p> <p>Tap the field and select the save format.</p>
OK, Save Waveform	<p>Saves the file to the specified location, closes the Save As configuration menu, and displays a confirmation message.</p>

RF configuration menu

Use the RF configuration menu to set RF channel vertical settings, trace settings, probe type, attenuation, and units for RF channel inputs.

To open an RF Channel configuration menu, double-tap the RF Channel badge.

1. If Off, tap the **RF** button on the Settings bar. The oscilloscope changes the RF button to an RF badge that shows the RF settings.
2. If On, double-tap the RF badge to open the RF menu.

RF Settings panel, fields and controls

Field or control	Description
Display	Toggles display of the channel On and Off.
Reference Level	Sets the approximate maximum power level, as shown by the baseline indicator at the top of the frequency graticule using the multipurpose knob, double-tap to bring up the virtual keypad, or tap the up and down arrows to change the level.
Auto Level	Directs the oscilloscope to automatically calculate and set the reference level for you.
Scale	Sets the scale using the multipurpose knob or double-tap to bring up the virtual keypad to change the scale.
Position	Sets the vertical position using the virtual keypad. You will move the baseline indicator up or down. This is useful if you want to move signals onto the visible display.
Set to 0	Sets the waveform zero level to the center of waveform view.
Label	Adds a label to the channel display using the virtual keypad.
Units	Selects the units from the drop-down list. Choices are: dBm, dBμW, dBmV, dBμV, dBmA, and dBμA. This is useful if your application requires a different unit of measurement than that being currently displayed.
Amplifier Mode	Sets whether to use an attached TPA-N-PRE preamplifier or bypass the amplifier.
Traces	Select the four different spectrum trace types that you can display. See Traces panel (RF configuration menu) on page 199.

Traces panel (RF configuration menu)

Use the RF configuration menu Traces panel to select spectrum traces, detection type, detection method, number of averages, and enable spectrogram.

To open the Traces panel:

1. If Off, tap the **RF** button on the Settings bar, the instrument changes the RF button to an RF badge that shows the RF settings.
2. Double-tap the **RF** badge to open the RF configuration menu.
3. Tap the **Traces** panel.

Traces panel, fields and controls.

Field or control	Description
Spectrum Traces	Toggles the different spectrum trace types on and off. The frequency domain window supports four spectrum traces. You may turn each of these traces on or off independently. You can display all or some of them simultaneously. Normal trace: Each acquisition is discarded as new data is acquired. Max hold trace: The maximum data values are accumulated over multiple acquisitions of the Normal trace. Min hold trace: The minimum data values are accumulated over multiple acquisitions of the Normal trace. Average trace: Data from the Normal trace is averaged over multiple acquisitions. This is true power averaging, which occurs before the log conversion. Each power of 2 averaging reduces the displayed noise by 3 dB.
Detection Method	Selects the method to reduce the FFT output to the display width.
Detection Type	Selects how the instrument compresses the FFT output to fit the display. The choices are: +peak, sample, average, and -peak. +Peak : Uses the highest amplitude point in each interval. Sample : Uses the first point in each interval. Average : Averages all points in each interval. -Peak : Uses the lowest amplitude point in each interval.
Number of Averages	Sets the number of averages to use when using the Average detection type. This control is only present when Average is checked.
Spectrogram	Toggles Spectrogram display on and off. The spectrogram display is useful for monitoring slowly-changing RF phenomena. The x-axis represents frequency, just like the typical spectrum display. The y-axis represents time. Color indicates amplitude. See Spectrogram display on page 295 for more information.

Horizontal badge configuration menu

Use this menu to configure the acquisition and display of the RF input.

To open the spectral configuration menu:

1. If Off, tap the **RF** button on the Settings bar, the instrument changes the RF button to an RF badge and displays the Spectral badge.
2. Double-tap the **Horizontal** badge to open the configuration menu.

Horizontal badge configuration menu, fields and controls

Field or control	Description
Center Frequency	Set the center frequency using the multipurpose knob or double-tap to bring up the virtual keypad.
Span	Selects the portion of the spectrum to view on the display. Tap to set the span using the multipurpose knob, double-tap to bring up the virtual keypad, or tap the up and down arrows to change the span
Start Frequency	Set the start frequency using the multipurpose knob or double-tap to bring up the virtual keypad.
Stop Frequency	Set the stop frequency using the multipurpose knob or double-tap to bring up the virtual keypad.
RBW Mode	Selects the resolution bandwidth mode, either Auto or Manual.
Span:RBW	Set the Span to RBW ratio using the multipurpose knob or double-tap to bring up the virtual keypad. This control is present when RBW Mode is set to Auto.
RBW	Set the resolution bandwidth using the multipurpose knob or double-tap to bring up the virtual keypad. This control is present when RBW Mode is set to Manual.
Window	<p>Tap and select the window from the list. The choices are:</p> <ul style="list-style-type: none"> ■ Rectangular (See Rectangular window on page 334.) ■ Hamming (See Hamming window on page 334.) ■ Hanning (See Hanning FFT window on page 333.) ■ Blackman-Harris (See Blackman-Harris FFT window concepts on page 333.) <p>The choice of which window to use depends upon what you want to measure and your source's signal characteristics.</p>

Spectral math configuration menu

The spectrum math feature lets you create a math waveform by adding or subtracting frequency traces. Spectrum Math is only available when the instrument is acquiring in RF mode.

To turn on a spectral math, with RF on, tap the **Add Math Ref Bus** button and select **Math**.

To open the spectral math configuration menu, double-tap a spectral math badge.

Spectral math configuration menu, fields and controls

Field or control	Description
Display	Toggles the spectral math display on and off.
Label	Add a label to the math trace using the virtual keypad.
Source 1	Select Source 1 from the list of valid sources.
Source2	Select Source 2 from the list of valid sources.
Operand	Select a math operator from the list.

Spectral Ref configuration menu

Use this menu to manage spectral reference waveforms and traces, including the display or removal of each reference waveform or trace from the display.

To turn on a spectral ref, with RF on, tap the **Add Math Ref Bus** button and select **Ref**.

To open the spectral ref configuration menu, double-tap a spectral ref badge.

Spectral Ref configuration menu, fields and controls

Field or control	Description
Display	Toggles the spectral ref on and off.
Label	Add a label to the reference display using the virtual keypad.
Scale	Set the scale using the multipurpose knob, double-tap to bring up the virtual keypad, or tap the up and down arrows to change the scale.
Position	Set the position using the multipurpose knob, double-tap to bring up the virtual keypad.
Set to 0	Sets the position to 0.
Ref Details	Readout with setup information saved with the waveform.

Cursor configuration menu

Cursors are on-screen lines (bars) that you position to take manual measurements on signals. They appear as horizontal and/or as vertical lines.

To display cursors on the screen:

1. Tap the **Cursors** button in the upper right of the display, or
2. Push the **Cursors** front-panel button to toggle cursors on or off.

To open the Cursors configuration menu:

1. Double-tap a cursor readout or cursor line, or
2. Touch and hold a cursor readout or cursor line and select **Configure Cursors** from the right-click menu.

Cursor configuration menu fields and controls

Some fields or controls are only available when certain other controls are selected.

Field or control	Description
Display	Toggle cursor On or Off.
Bring Cursors On Screen	Brings the cursors on screen. This is only available in time domain mode.
Reference To Center	Brings the reference to center screen. This is only available in frequency domain mode.
Cursor Type	Select the cursor type from the drop-down list. Waveform cursors measure vertical amplitude and horizontal time parameters simultaneously at the point the cursor crosses a waveform. Screen cursors use two horizontal and two vertical bars that span the graticule to take manual measurements.
Source	Select the source waveform from the drop-down list. Default is the selected waveform.
Cursor A X-Position	Set a specific x-axis position for Cursor A using the multipurpose knob, or double-tap to set the position using the keypad.
Cursor B X-Position	Set a specific x-axis position for Cursor B using the multipurpose knob, or double-tap to set the X-Position using the keypad.
Cursor Mode	Select the cursor mode. This is only available in time domain mode. Independent mode sets multipurpose knobs A and B to move each cursor separately (default). Linked mode sets multipurpose knob A to move both cursors at the same time. Knob B will still move cursor B independently of knob A.
Readout	Selects the readout mode, Absolute or Delta. Delta readouts are relative to the Reference Marker. This is only available in frequency domain mode.

Date and Time configuration menu

Use this menu to set the date, time, and UTC offset.

To open the Date and Time configuration menu, double-tap on the Date/Time badge in the lower-right corner of the oscilloscope display.

Date and Time configuration menu fields and controls

Field or control	Description
Display	Toggles display of the date and time On or Off. When turned off, tap on the blank area below the Status badge, in the lower-right corner of the oscilloscope display, to open the configuration menu and set display to On .
Year	Use the multipurpose knob to set the year.
Month	Select from the list.
Day	Use the multipurpose knob to set the day
Hour	Use the multipurpose knob to set the hour.
Minute	Use the multipurpose knob to set the minute.
UTC Offset	Use the multipurpose knob to set the offset.
Ok, Set Date & Time	Applies your date and time settings.

Digital channel configuration menu

Use the Digital channel menu to enable individual digital channels, set their thresholds, and add labels.

To open the Digital channel configuration menu, double-tap a Digital channel badge. You can also double-tap on the digital channel handles to open the menu.

Digital channel settings fields and controls

Field or control	Description
Display	Toggle display of the channels On and Off. You can turn the channel off and then back on and have the same bits displayed as before.
Height	Sets the relative height of the digital waveform on the screen.
D7-D0 Bit	Toggles individual channels (bits) on or off and remove them from the display.
D7-D0 Threshold	Sets threshold level values for the D7-D0 data channels.
D15-D8 Bit	Toggles individual channels (bits) on or off and remove them from the display.
D15-D8 Threshold	Sets threshold level values for the D15-D8 data channels.
Label	Enter label text for individual data channels. The label is shown to the right of the corresponding digital channel.

Field or control	Description
Turn All Off	Turns off the digital channel group and becomes Turn All On.
Turn All On	Turns on the digital channel group and becomes Turn All Off.

Right-click menu differences

A right click (touch and hold) on the digital channel waveform handle opens a menu to turn off that instrument channel, configure the overall digital channel settings, or add a label to the digital channel.

A right click (touch and hold) on the handle of individual digital bits in a digital channel waveform opens a menu to turn off that digital bit, configure the overall digital channel settings, or add a label to the individual bit.

See also [Analog channel configuration menu](#)

DVM configuration menu

Use this menu to set up the optional digital voltmeter (DVM) function to use probes to measure AC, DC, or AC+DC voltages.

To open the digital voltmeter menu:

1. If the DVM is Off, tap the **DVM** badge on the Settings bar. This adds a DVM badge to the top of the Results Bar, using the source that was selected the last time the DVM was added to the Results bar.
2. If the DVM is On, double-tap the **DVM** badge to open its configuration menu.

NOTE. *Selecting a source in the DVM configuration menu does not automatically turn on (display) the source channel if the source channel is not already on.*

DVM configuration menu fields and controls

Field or control	Description
Display	Toggles the DVM badge On and Off.
Autorange	Toggles autoranging On and Off. Autorange is not available when the oscilloscope is triggering on the same channel that is being measured.
Source	Select the channel to measure from the drop-down list. The DVM can only measure analog channels.
Mode	Select DC, AC RMS, or DC+AC RMS measurement modes.
Show Basic Statistics in Badge	Toggles showing DVM measurement statistics in the DVM badge On and Off.

Menu bar overview

The Menu bar provides access to file, utility, and help functions.

The Menu bar

Field or control	Description
File	<p>Provides typical system file management operations such as opening, saving, moving, and renaming files.</p> <p>See Recall configuration menu (File menu) on page 206.</p> <p>See Save As configuration menu (File menu) on page 207.</p> <p>See File Utilities configuration (File menu) on page 212.</p> <p>Autoset executes an immediate Autoset operation. See Quickly display a waveform (autoset) on page 68.</p> <p>Default Setup immediately restores the oscilloscope to factory default settings. See Using Default Setup on page 86.</p> <p>Shutdown powers off the oscilloscope.</p>
Utility	<p>Use to set user preferences, configure input, output, and network settings, run self tests, verify calibration status and run signal path compensation, and erase nonvolatile memory.</p> <p>See User Preferences (Utility menu) on page 215.</p> <p>See I/O (Utility menu) on page 217.</p> <p>See Self Test configuration menu (Utility menu) on page 221.</p> <p>See Calibration configuration menu (Utility menu) on page 222.</p> <p>See Security configuration menu (Utility menu) on page 223.</p> <p>See Demo (Utility menu) on page 226.</p>
Help	<p>Use to open the Help viewer and display current instrument software and option license information.</p> <p>See Help (Help menu) on page 227.</p> <p>See About (Help menu) on page 227.</p>

**Recall configuration menu
(File menu)**

Use this menu to recall (load) reference waveforms and instrument setups.

Drive name	Drive letter	Drive or physical USB port location
Root drive	Instrument Storage	User-accessible memory on the oscilloscope
Front panel	E	USB 2.0 (top)
	F	USB 2.0 (bottom)
Rear panel	G	USB 2.0
	H	USB 2.0 device port provides USBTMC support
Network location	I through Z	Network storage locations

To open the file Recall configuration menu:

1. Tap **File** on the menu bar.
2. Tap **Recall** to open the Recall configuration menu.

Recall configuration menu fields and controls.

Field or control	Description
File type to open (tabs)	Tabs on the left let you set which type of file to recall (Waveform or Setup).
Directory structure	The Name column lists the directory structure, opening at the root (/) level. Use to quickly navigate to a file. Tap to list the contents of the directory in the Name pane. Tap the + button to display the directory and any subdirectories under it. Tap the - button to close that directory structure. Drag the scroll bar up and down to show more entries.
+ and -	Use the + and - buttons to navigate the file directory. The - button closes the folder. The + button opens a folder.
Scroll bar	Use the scroll bar to access additional files and folders, when available.
Recall To:	Select which reference waveform location to store the recalled waveform in. Text is included below the buttons that indicates the last time the selected reference was modified.
OK, Recall Waveform	Recalls the selected file. Button is not available if installing a setup. This button is grayed out if a valid file is not selected in the navigation pane. Recalling a waveform file adds a Reference waveform badge to the Settings bar and displays the waveform as it fits in the current Horizontal setting.
OK, Recall Setup	Recalls the selected file and immediately sets the oscilloscope to the settings in the file. Button is not available if installing a waveform. This button is grayed out if a valid file is not selected in the navigation pane.

Drive and USB port designations. Use the following table to determine which drive to select when navigating to and/or selecting a file on system memory or a connected USB memory device.

Drive name	Drive letter	Drive or physical USB port location
Root drive	Instrument Storage	User-accessible memory on the oscilloscope
Front panel	E	USB 2.0 (top)
	F	USB 2.0 (bottom)
Rear panel	G	USB 2.0
	H	USB 2.0 device port provides USBTMC support
Network location	I through Z	Network storage locations

Save As configuration menu (File menu)

Use this menu to configure saving screen captures, waveforms, and oscilloscope setup files.

To access the **Save As** configuration menu, tap **File** on the menu bar and select **Save As...**

NOTE. Selecting **File > Save** the first time after powering up the instrument opens the **Save As** configuration menu. This lets you set or verify the save locations for all types of information you can save.

Once the **Save As** configuration menu has been opened and closed, the next time you select **Save** causes the instrument to automatically save the file type last selected in the **Save As** configuration menu. This lets you quickly save files with a simple menu selection.

Saving files with the front-panel User button. Pushing the front-panel **Save** button automatically saves the file type last selected in the **Save As** configuration menu. If no saves have been performed since the instrument power-up, pushing the **Save** button opens the **Save As** configuration menu. Select the type of save operation you want to perform and tap **OK**. After that, pushing the **Save** button automatically saves the file type.

NOTE. The **Save** button is not assigned a specific save type by default; it retains whatever save action was last selected in the **Save As** configuration menu.

Save As configuration menu fields and controls. The following fields and controls are common to all Save As actions.

Field or control	Description
File save type	<p>Tabs on the left let you set which type of file to save (Screen Capture, Waveform, Setup, or All). Selecting a file type sets the file extensions in the Save As Type field to the correct value.</p>
File navigation pane	<p>Lists the location where the file will be saved. The default value is the last location to which a file was saved. Navigate to and select the location to which to save the file.</p> <p>Use the + and - buttons to navigate the file directory.</p> <p>The - button closes the folder.</p> <p>The + button opens a folder.</p> <p>Removable media devices indicate their remaining free space in the title of the device.</p> <p>The size of individual files is indicated in the Size column.</p> <p>The date and time of the last modification to files and folders is displayed in the Date Modified column.</p> <p>The navigation window only shows files relevant to the menu it's contained in and the choices the you make. For example, when set to recalling waveforms, the only files shown will be waveform files.</p>
File Name	<p>The file name assigned to the file. The default value is either the user-entered name used to last save this file type, or a numeric value calculated by the instrument if this file type has not previously been saved with a custom file name. The default value is Tek000.</p> <p>Tap the down arrow on the right edge of the field to display and select from a list of recently-saved file names.</p> <p>Tap on the file name and use a keyboard to enter a new file name. Or double-tap on the file name to open the virtual keyboard and enter a file name.</p>
Format	<p>Lists the available formats to which you can save files. The available save formats are set by the type of file being saved.</p> <p>Tap the field and select the save format.</p>

Screen Capture tab fields and controls. The following settings are specific for saving a screen capture

Field or control	Description
File save type	Use the Screen Capture tab to save a screen image to a file. Selecting Screen Capture sets the file extensions in the Save As Type field to available graphic file formats.
Format	Lists the available formats to which you can save files. The available save formats are set by the type of file being saved. Tap the field and select the graphic save format.
Ink Saver	Toggles Ink Saver mode on and off.
OK, Save Screen Capture	Saves the file to the specified location, closes the Save As configuration menu, and displays a confirmation message.

Waveform tab fields and controls. The following settings are specific for saving a waveform.

Field or control	Description
File save type	Use the Waveform tab to save waveform(s) to a file. Selecting Waveform sets the file extensions in the Save As Type field to available waveform file formats.
Save As Type	Lists the available formats to which you can save files. The available save formats are set by the type of file being saved. Tap the field and select the graphic save format.
Format	Select the waveform save format.
Source	Sets the waveform source to save. You can save a single waveform, or save all active (displayed) waveforms.
Gating	Sets the method to save a specified part of the waveform data. None saves the full waveform data (default). Cursors saves the waveform data located between the vertical cursors. If cursors aren't on when selecting cursor gating, the cursors are activated. Screen saves the waveform data that is on the screen. Gating notes: <ul style="list-style-type: none"> ■ Default Setup restores Gated Save to its default setting (None). ■ The state of Gated Save gets saved in Setup and Session files. ■ Gated saves do not work on plot waveform data. ■ Gating cannot be used to save waveform data while in FastFrame mode.
OK, Save Waveform	Saves the file to the specified location, closes the Save As configuration menu, and displays a confirmation message. The active (displayed) waveforms are saved.

Setup tab fields and controls. The following settings are specific for saving an instrument setup.

Field or control	Description
File save type	Use the Setup tab to save the instrument setup and measurement settings to a file. Selecting Setup sets the file extension in the Save As Type field to .set.
OK, Save Setup	Saves the file to the specified location, closes the Save As configuration menu, and displays a confirmation message.

Save All tab fields and controls. The following settings are specific for saving all file types including: screen capture, waveforms, and setup files. An external drive (USB) must be connected to save all file types.

NOTE. *The save all function saves each file type according to the latest save settings in the **Screen Capture**, **Waveform**, and **Setup** tabs.*

Field or control	Description
File save type	Use the All tab to save all file types. All files saved use the user-specified filename followed by extensions that distinguish the file types. The types of files saved is determined by the configuration of your instrument.
Save	Saves the files to the specified location, closes the Save As configuration menu, and displays a confirmation message.

Print configuration menu Use this menu to print a screen capture.

Print configuration menu fields and controls..

Field or control	Description
Add Printer	Opens the Add Printer configuration menu.
Delete Printer	Deletes the selected printer.
Set as Default	Sets the selected printer as the default printer.
Printer list	Displays the available printers with the selected printer highlighted.
Orientation	Select Landscape or Portrait print mode.
Ink Saver	Toggles Ink Saver mode on and off.
Print Preview	Displays what will be printed as long as you touch the button.
OK Print	Prints the screen capture to the specified printer and closes the Print configuration menu.

Add Printer configuration menu

Use this menu to add a new printer or specify an email address.

Print configuration menu fields and controls..

Field or control	Description
Printer Type	Specify a Network printer or an E-mail.
Printer Name	Use the keyboard to enter the printer name. Only available when Network is selected.
Server Name	Use the keyboard to enter the server name. Only available when Network is selected.
Server IP Address	Use the keypad to enter the server IP address. Only available when Network is selected.
Printer E-mail Address	Use the keyboard to enter the printer email address. Only available when E-mail is selected.
SMTP Server Name	Use the keyboard to enter the SMTP server name. Only available when E-mail is selected.
Server Port	Use the keypad to enter the port number of the server. Only available when E-mail is selected.
Host Wanted	Use the keyboard to enter the host wanted. Only available when E-mail is selected.
User Name	Use the keyboard to enter your user name. Only available when E-mail is selected.
User Password	Use the keyboard to enter your password. Only available when E-mail is selected.
OK, Add Printer	Adds the printer to the list of available printers and closes the menu.

File Utilities configuration (File menu)

Use this menu to copy, paste, delete, and rename files, create folders, and mount and unmount memory devices.

To access the **File Utilities** configuration menu, select **File > File Utilities** from the Menu bar.

File Utilities configuration menu fields and controls.

Field or control	Description
File navigation pane	<p>Shows the current directory structure. Navigate to and select the files or folder to act on. Use the + and - buttons to navigate the file directory.</p> <p>The - button closes the folder.</p> <p>The + button opens a folder. Removable media devices indicate their remaining free space in the title of the device. The size of individual files is indicated in the Size column. The date and time of the last modification to files and folders is displayed in the Date Modified column. Drag the scroll bar up and down to show more entries.</p>
	<p>Use the + and - buttons to navigate the file directory.</p> <p>The - button closes the folder.</p> <p>The + button opens the folder.</p>
Copy	Copies the selected file in the filename pane to memory.
Paste	Pastes the file from the last Copy action in the current File Utilities session into the current location.
Delete	Deletes the selected file or folder.
Rename	Renames the selected file or folder.
New Folder	Creates a new folder.
Mount	<p>Mount the selected drive.</p> <p>For USB drives, Mount opens the file writing session on the attached USB device to let you write to the device. The device is also added to the Drive column of menus that can access drives.</p>
Unmount	<p>Unmount the selected drive. Select the drive letter and tap Unmount.</p> <p>For USB drives, Unmount closes the file writing session on the attached USB device to let you disconnect the device from the USB port. The device is also removed from the Drive column of menus that can access drives.</p>

Drive and USB port designations. Use the following table to determine which drive to select when navigating to and/or selecting a file on system memory or a connected USB memory device.

Drive name	Drive letter	Drive or physical USB port location
Root drive	Instrument Storage	User-accessible memory on the oscilloscope
Front panel	E	USB 2.0 (top)
	F	USB 2.0 (bottom)
Rear panel	G	USB 2.0
	H	USB 2.0 device port provides USBTMC support
Network location	I through Z	Network storage locations

Mount Network Drive configuration menu

Use this menu to connect to a network device, such as a PC or a file server, to save setups, waveforms, and screen images directly to the drive or to recall waveforms or setups from the drive.

To save to or recall files from a network drive, you must first connect your oscilloscope to the network.

NOTE. Consult your network administrator for information related to your network.

To open the **Mount Network Drive** menu:

1. Select **File > File Utilities** from the Menu bar.
2. Tap **Mount** to open the **Mount Network Drive** menu.

Mount Network Drive configuration menu fields and controls.

Field or control	Description
Drive Letter	Shows the current list of available (unassigned) drive letters. Tap on the list and select a drive letter to assign to the network drive.
Specify Server	Sets how you specify the server location; by server Name or IP address.
Server Name	The server name associated with the remote drive. Double-tap the field and enter the server name. This control is only present when Specify Server is set to Name.
Server IP Address	The IP address of the server. Tap the field and enter the network drive's IP address. This control is only present when Specify Server is set to IP Address.
Path	The path to the network drive. Double-tap the field and enter the network drive path information.
User Name	If the drive you are mounting is password-protected, use this field to enter the user name associated with the drive. Double-tap the field and enter the user name.
Password	If the drive you are mounting is password-protected, use this field to enter the password associated with the drive. Double-tap the field and enter the password.
Cancel	Closes the menu without taking any action.
Enter	Submits the drive access information to the network drive server. If successful, the menu is dismissed, a confirmation message is displayed, and the drive is added to the Drive column of file menus that access drives. If not successful, the menu remains on screen and an error message is displayed. Use the error message to resolve the login problem.

User Preferences (Utility menu)

Use this menu to set global display and other user preferences.

To open the **User Preferences** menu:

1. Tap **Utility** menu.
2. Tap **User Preferences** to open the configuration menu.

User preferences fields and controls.

Field or control	Description
Language	Select the language from the list. English is the default.
Measurement Annotations	<p>Annotations show the exact segment of the waveform from which the measurement is derived. The annotation types consist of horizontal bars, vertical bars, or cross-hatch marks.</p> <p>Auto sets annotations to display if valid for the measurement. To view annotations for a measurement, select that measurement badge. If annotations are valid for that measurement, they are added to the measurement source waveform.</p> <p>Off turns off display of measurement annotations.</p>
Backlight Intensity	<p>Selects the intensity of the backlight.</p> <hr/> <p>NOTE. Performing an Autoset resets the backlight value to High.</p> <hr/>
Auto-Dim	Select On to automatically dim the screen backlight after a specified time.
Time	<p>Sets the amount of time to wait before the display is dimmed. Tap in the field and use the knob to change the time value, or double-tap to open the virtual keypad and set a time value.</p> <p>Only available when Auto-Dim is On.</p>
Right Clicks via Touch	Turns On or Off the ability to use touch and hold method to open right-click menus on badges and other screen items.
Time	<p>Sets the time it takes to respond to a touch and hold before opening a right-click menu.</p> <p>Only available when Right Clicks via Touch is On.</p>
Assign Save Button To Quick Print	Assigns the Save button to quick print. When your printer is set up, and this button is checked, pressing the front panel Save button will print to your printer. If a printer has not been set up, the Print configuration menu is opened.

I/O (Utility menu) Use this configuration menu to set up a LAN, USB Device Port, Socket Server, and AUX OUT signal parameters.

To open the I/O menu:

1. Tap the **Utility** menu.
2. Tap **I/O...**

Entering and applying LAN network changes.

When first opening the I/O menu LAN panel, the Network Address is set to **Auto** (default setting) and the **Apply Changes** button is grayed out (inactive) in the LAN panel.

When you select any editable input box and start entering data, the **Apply Changes** button becomes active, and the characters being entered are bolded and italicized. Bold italicized text means that the values have not been applied to the oscilloscope settings.

When you tap the **Apply Changes** button, all changes are saved (takes about 10 seconds), the text is changed to normal font (nonbold, nonitalic), and the **Apply Changes** button becomes inactive.

If you tap outside the I/O menu before you tap the Apply Changes button, the menu closes and none of your changes are saved.

LAN panel fields and controls.

Field or control	Description
LAN Status	A readout that indicates the status of the LAN connection, either a Green circle with the word Ok or a Red circle with an error message.
Host Name	The instrument host name is displayed. To change the name, double-tap and enter a name in the virtual keyboard.
Network Address	Select Manual or Automatic mode. The current Instrument IP Address, Gateway IP Address, Subnet Mask, and DNS IP Address are displayed. In Manual mode the fields are editable.
Domain Name	The instrument domain name is displayed. To change the name, double-tap and enter a name in the virtual keyboard.
Instrument IP Address	Use the multipurpose knobs to enter the address. Use the A knob to select the digit, and the B knob to change the value. Only available to edit when Network Address = Manual
Subnet Mask	Use the multipurpose knobs to enter the mask. Use the A knob to select the digit, and the B knob to change the value. Only available to edit when Network Address = Manual
Service Name	The instrument service name is displayed. To change the name, double-tap and enter a name in the virtual keyboard.
Gateway IP Address	Use the multipurpose knobs to enter the address. Use the A knob to select the digit, and the B knob to change the value. Only available to edit when Network Address = Manual
DNS IP Address	Use the multipurpose knobs to enter the address. Use the A knob to select the digit, and the B knob to change the value. Only available to edit when Network Address = Manual
MAC Address	A readout of the instrument MAC Address. This field is not editable.
e*Scope HTTP Port	A readout of the instrument e*Scope HTTP port number. This field is not editable.
Test Connection	Test the connection. If the connection test is successful, then OK is displayed. If the test is unsuccessful, then No Response is displayed.
LAN Reset	Display the LAN Reset configuration menu (Utility > I O menu) on page 220.
Apply Changes	Apply changes made on this panel to the instrument. NOTE. No changes are made to instrument settings until you tap the <i>Apply Changes</i> button.

USB Device Port fields and controls. Use the USB Device Port panel to enable or disable the USB port and set the GPIB Talk/Listen address. Use USB ports to connect a USB memory device, keyboard, or for direct PC control of the oscilloscope using USBTMC protocol.

Field or control	Description
USB Device Port	Toggles the USB device port On and Off.
USBTMC Configuration	Displays the USBTMC configuration information.
GPIB Talk/Listen Address	Enter the address using the virtual keypad.

Socket Server panel fields or controls. Use the following socket server settings to set up and use a socket server between your oscilloscope and a remote terminal or computer.

Field or control	Description
Socket Server	Toggles the socket server On or Off.
Protocol	Tap to select a protocol, either None or Terminal. A communication session run by a user at a keyboard typically uses a terminal protocol. An automated session might handle its own communications without such protocol from the oscilloscope.
Port	Enter the port number using the multipurpose knob or virtual keypad.

AUX Out panel fields and controls. Use the following settings to select the signal that is output on the rear-panel AUX Out signal connector.

Field or control	Description
AUX Out Signal	Select the signal type to send to the AUX Out connector. Trigger sends a pulse for each trigger occurrence. The instrument will output a negative edge during a specified trigger or other event. Event sends a pulse for each event occurrence. AFG sends a pulse that is synchronized to the AFG output signal.

Using Telnet to communicate with the oscilloscope.

1. After you have set up the socket server parameters and set the Protocol to Terminal, the computer is ready to communicate with the oscilloscope. If you are running an MS Windows PC, you could run its default client Telnet, which has a command interface. One way to do this is by typing Telnet in the Run window. The Telnet window will open on the PC.

NOTE. *On MS Windows 10, you must first install Telnet.*

2. Start a terminal session between your computer and your oscilloscope by typing in an open command with the oscilloscope's LAN address and port number.

You can obtain the LAN address by tapping **Utility > I/O**. In the LAN panel the Instrument IP Address is displayed. You can obtain the port # by tapping **Socket Server** and viewing current Port number in the Port field of the menu.

For example, if the oscilloscope IP address was 123.45.67.89 and the port # was the default of 4000, you could open a session by writing into the MS Windows Telnet screen: o 123.45.67.89 4000.

The oscilloscope will send a help screen to the computer when it has finished connecting.

3. You can now type in a standard query, such as, *idn?.

The Telnet session window will respond by displaying a character string describing your instrument.

You can type in more queries and view more results using this Telnet session window. You can find the syntax for relevant commands, queries and related status codes in the Programmer Manual that is available at the Tektronix website.

NOTE. *Do not use the computer's backspace key during an MS Windows Telnet session with the oscilloscope.*

LAN Reset configuration menu (Utility > I O menu)

Use this menu to reset the Local Area Network (LAN) settings to the listed default settings.

To open the LAN Reset dialog:

1. Tap **Utility** in the Menu bar.
2. Tap **I/O...**
3. Tap the **LAN Reset** button to open the LAN Reset configuration menu.
4. Tap **OK** to reset the LAN settings.
5. Tap **Cancel** to close the dialog without taking any action, and return to the I/O configuration menu.

LAN Reset default settings.

Function	Setting
Network address	Automatic
DHCP	Enabled
BOOTP	Enabled
mDNS & DNS-SD	Enabled
e* Scope Password Protection	Disabled
LXI Password Protection	Disabled
e* Scope and LXI Password	Empty string (default)

See also.

[I/O \(Utility menu\)](#) on page 217

Self Test configuration menu (Utility menu)

Use this menu to view power-on diagnostic results, run extended self tests, and verify the 250 k Ω termination control works on input channels.

To open the **Self Test** configuration menu:

1. Tap **Utility** in the Menu bar.
2. Tap **Self Test...**

Tap anywhere outside of the menu to close the menu.

NOTE. Remove all input signals before running the extended self tests.

Self Test configuration menu fields and controls.

Field or control	Description
250 kΩ Verification	Opens a menu to verify that 250 kΩ termination can be enabled or disabled for each channel. Closing the menu restores the normal termination setting.
Error Log	Opens a menu that lets you view the instrument log file. The log file is a valuable information resource when working with Tektronix Customer Support to troubleshoot a problem or report an issue.
Power-on Self test Results	Displays the power-on self test status (Passed or Failed).
Extended Self Test Results	Lists the status of each Extended self tests (Passed or Failed). If one or more tests fail at power-on, tap on Run Self Test and see if the test or tests continue to fail. If tests continue to fail, contact your nearest Tektronix Service Center for help with resolving the problem.
Run N Times	Double tap to open the Run N Times menu and set the number of times to run the extended self tests.
Run Self Test / Abort Self Test	Runs the extended self tests. While tests are running, the button changes to Abort Self Test . When self tests are stopped, the button reverts to Run Self Test . <i>NOTE. Remove all input signals before running the extended self tests.</i> Tap the Abort Self Test button anytime to stop testing.

Calibration configuration menu (Utility menu)

Use this menu to perform a signal path compensation or view the factory calibration status.

To open the Calibration configuration menu:

1. Tap **Utility** in the Menu bar
2. Tap **Calibration...**

Calibration configuration menu fields and controls.

Field or control	Description
Factory Adjustment Status	This area at the top of the menu lists the instrument calibration status. Factory Adjustment Status should be Passed. If an instrument becomes uncalibrated, this displays a red Uncalibrated status. Contact your nearest Tektronix Service Center for assistance.
SPC Status	Indicates the status of the last SPC run (Pass, Failed, or Running). Also indicates how long ago the last SPC was run.
Run SPC	Signal path Compensation (SPC) corrects for internal DC inaccuracies caused by temperature variations and/or long-term drift in circuits. NOTE. SPC takes less than 10 minutes per channel to run. Allow the instrument to warm up for 20 minutes before running SPC. Remove all probes, cables, and adapters from all input connectors before running SPC. Tap Run SPC to run signal path compensation.

Security configuration menu (Utility menu)

If you have acquired confidential data, use TekSecure[®] to erase the oscilloscope memory before you return the oscilloscope to general use.

To run the Security process:

NOTE. Save any important waveform, screen capture, instrument setup, report, and session files to external memory before running TekSecure. All such files will be erased.

1. Tap **Utility** in the Menu bar.
2. Tap **Security...**
3. Tap **Run TekSecure** to erase nonvolatile memory. It will take approximately seven minutes to erase the memory.
4. To exit the dialog without running TekSecure, tap outside of the configuration menu.
5. Push the **Default Setup** front panel button to load memory with the instrument factory settings.

NOTE. Save any important waveform, screen capture, instrument setup, report, and session files to external memory before running TekSecure.

NOTE. You cannot stop the TekSecure process once it is started.

NOTE. Do not power down the instrument while TekSecure is running.

NOTE. TekSecure does not erase calibration constants or instrument firmware.

Table 15: Security configuration menu fields and controls

Field or control	Description
TekSecure Erase Memory	Erases nonvolatile memory. It will take approximately several; minutes to erase the memory. NOTE. You cannot stop the TekSecure process once it is started. <i>Do not power down the instrument while TekSecure is running.</i> <i>Save any important waveform, screen capture, instrument setup, report, and session files to external memory before running TekSecure.</i> <i>TekSecure does not erase calibration constants or instrument firmware.</i>
Advanced panel (Optional)	Set password for enabling I/O ports and firmware updates.
Set Password	Use the keyboard to enter a password.
Enter Password	Use the keyboard to enter the password. This is only available when a password has been set.
Change Password	Use the keyboard to change the password. This control is only present when a password has been set and entered.
I/O Ports (USB, LAN)	Enable (On) or disable (Off) all USB ports (Device and Host) and the LAN port.
Firmware Updates	Enable (On) or disable (Off) the ability to update the oscilloscope firmware.

Enter Password configuration menu (optional)

Use this function to enter the password to access optional security functions. This menu is only shown on instruments with the optional security function installed.

To enter the password to allow changing the selected security feature state (On or Off):

1. Tap **Utility** in the Menu bar.
2. Tap **Security**.
3. Tap **Advanced** to open the Advanced panel.
4. If a password has not been entered and set, tap **Set Password** and enter the New Password. Tap the **Repeat New Password** field and reenter the password. Tap **Set Password** to set the password and close the dialog.
5. If a password is set, tap **Enter Password** and enter the password.
6. Tap **Enter Password** to enter the password and close the dialog.

After entering the password you can do the following:

- Change your password
- Enable or disable the I/O ports
- Enable or disable firmware updates

Enter Password configuration menu fields and controls.

Field or control	Description
Enter Password	Enter the password. The valid range of characters for the password is from one to 32 characters. Entering no characters or more than 32 characters results in an error message. <i>NOTE. If the instrument has a keyboard attached, and you have disabled the USB ports, double-tap on the password field to open the virtual keyboard and enter the password.</i>
Change Password	Use the displayed controls to change to a new password.
I/O Ports (USB, LAN)	After entering the password, tap to toggle the I/O ports on or off.
Firmware Updates	After entering the password, tap to enable/disable firmware updates..

Set Password configuration menu (optional)

Use this function to set the password used to access the optional security functions. This menu is only shown on instruments with optional security functions installed.

To access the Set Password configuration menu:

1. Tap **Utility** in the Menu bar.
2. Tap **Security**.
3. Tap **Advanced** to open the Advanced panel.
4. Tap **Set Password**.
5. In the New Password field, enter the new password.

6. In the Repeat New Password field, enter the new password.
7. Tap **Set New Password** to set the password and close the menu.

Set Password menu fields and controls ¹.

Field or control	Description
Set Password	Opens the dialog for changing the password. ²
Password	Enter the new password.
Repeat Password	Reenter the new password.
Set New Password	After entering the new password, tap Set Password to set the password and close the dialog.
I/O Ports (USB, LAN)	After entering the password, tap to toggle I/O Ports on or off.
Firmware Updates	After entering the password, tap to enable/disable firmware updates..

Demo (Utility menu)

Use this menu to access demonstrations of key oscilloscope features.

To open the Demo configuration menu, tap **Utility > Demo...** in the Menu bar.

Demo menu fields and controls.

Field or control	Description
Demo overview pane	The upper section of the menu shows an overview of the demonstration available in the selected panel. This pane may also contain a screen shot showing the waveforms and capability being demonstrated.
Demo buttons	Selecting a button updates the upper half of the menu to show the relevant content (and image if available) for the selected demonstration.
Recall Demo Session	Loads the session file for the selected demonstration.
Cancel	Exits the menu without making any changes.

¹ If the instrument has a keyboard attached, and you have disabled the USB ports, double-tap on the password field to open the virtual keyboard and enter the password.

² The valid range of characters for the password is from one to 32 characters. Entering no characters or more than 32 characters results in an error message.

Help (Help menu) Tap **Help > Help** to open the Help viewer. This Help viewer is similar in operation to traditional help viewers.

About (Help menu) Use the About configuration menu to show instrument information and installed options, and to install a license.

To open the About menu:

1. Tap **Help** on the menu bar.
2. Select **About** from the menu to open the About configuration menu.

About configuration menu fields and controls.

Field or control	Description
System information	Provides system-related information such as model, bandwidth, serial number, and installed firmware version. Provide this information when communicating with Tektronix to purchase option licenses or communicate with Customer Support.
Probes Detected	Lists probes connected to the instrument. Probes may list the probe model, serial number, and installed probe firmware version. Some probes may show their attenuation factor. <i>NOTE. Connecting or disconnecting probes while the About menu is open does not update the Probes Detected list. The Probes Detected list is not dynamic.</i>
Options	Lists the options installed on the instrument.
Install License	This button opens the Install License dialog to enter your license key.

Horizontal configuration menu

Use this menu to set horizontal parameters and enable trigger delay.

To open the **Horizontal** configuration menu, double-tap the **Horizontal** badge in the Settings bar.

Horizontal configuration menu fields and controls

Field or control	Description
Horizontal Scale	<p>Set the Horizontal Scale using the assigned multipurpose knob, double-tap to set the scale using the virtual keypad, or tap the up and down arrows. You can also use the front-panel Horizontal Scale knob to change this value.</p> <p>The horizontal scale determines the size of the acquisition window relative to the waveform. You can scale the window to contain a single waveform edge, a single cycle, several cycles, or thousands of cycles.</p>
Delay	<p>Delay positions the trigger event to a specified time relative to the center of the waveform record. Use delay to focus on events that occur before (pretrigger) or after the trigger point (posttrigger).</p>
Position	<p>Set the trigger Position using the assigned multipurpose knob or double-tap to set the Position using the virtual keypad.</p> <p>When horizontal Delay is on, the time from the trigger point to the horizontal reference (center of waveform record) is the horizontal delay. The horizontal position determines the number of pretrigger and posttrigger samples in the waveform record.</p> <p>When horizontal delay is off, the trigger point and the horizontal reference are at the same time in the middle of the waveform record.</p>
Set to 0 s	<p>Sets the delay position to 0 s (center of the waveform record). Only available when Delay = On.</p>
Set to 10%	<p>Sets the trigger delay to 10% of the waveform record.</p> <p>Only available when Delay = Off.</p>
Record Length	<p>Select the Record Length from the drop-down list.</p>

Math configuration menu overview

Math waveforms are created by combining and/or mathematically transforming source waveforms into a new waveform for analysis. Use this menu to create math waveforms (basic or advanced) or add an FFT (Fast Fourier Transform) waveform to the screen.

To access a Math configuration menu, tap the **Add Math Ref Bus** badge on the Settings bar. Tap the **Math** button to add a Math waveform badge. Double-tap the **Math** badge to open the configuration menu.

Use the following links to access information on the Math waveform menus and settings.

[Math configuration menu](#) on page 229

[Equation Editor \(Math configuration menu\)](#) on page 231

Math configuration menu

Use this menu to set math waveform parameters, create basic and advanced math waveforms, or add an FFT (Fast Fourier Transformation) waveform to analyze the frequency components of a waveform.

To access the Math menu, double-tap a **Math** waveform badge. If no Math badge is present, tap the **Add Math Ref Bus** button, tap **Math** to add a math badge, and double-tap the **Math** badge to open the menu.

Math configuration menu fields and controls.

Field or control	Description
Display	Turns the math waveform or FFT On or Off.
Vertical Scale	Sets the vertical graticule scale units. Tap the arrows to change the value, tap and use the assigned multipurpose knob to change values, or double-tap to open the virtual keypad to enter a specific value.
Auto Scale	Toggles Auto Scale mode on or off. Auto Scale calculates the vertical scale and position to center and display the entire waveform.
Label	Enter a label for the math waveform.
Vertical Position	Sets the vertical position of the math waveform.
Set to 0	Sets the vertical position of the math waveform to zero (vertical center of the screen).
Math Type	<p>Sets the type of math waveform to display.</p> <p>Basic creates a math waveform by adding, subtracting, multiplying, or dividing two analog waveforms.</p> <p>FFT creates an FFT math waveform of the specified signal to display the frequency components of that signal.</p> <p>Advanced allows you to define a more complex math expression. This mode also provides access to the Equation Editor.</p>
Source, Source1, Source 2	<p>Defines the signal source or sources for a Basic or FFT math waveform.</p> <p>Basic and FFT math waveforms are created from analog channels only (Ch, Math, or Ref).</p> <p>Available when Math Type = Basic or FFT.</p>
Basic math operation list	<p>Located between the Source 1 and Source 2 fields. A drop-down list to select a basic math operation (add, subtract, multiply, or divide) to apply to the two sources.</p> <p>Available when Math Type = Basic.</p>
Math Expression	<p>Math Expression shows the current advanced math expression.</p> <p>Tap Edit to open the Equation Editor to edit the displayed equation. You can also double-tap on an equation in this field and directly edit the equation using the virtual keyboard. See Equation Editor (Math configuration menu) on page 231.</p> <p>Available when Math Type = Advanced</p>
Edit	<p>Opens the Equation Editor to create advanced math waveforms from analog channels, reference, measurement, and variable sources.</p> <p>Tap the Edit button to open the Equation Editor. See Equation Editor (Math configuration menu) on page 231.</p> <p>Available when Math Type = Advanced</p>

Field or control	Description
Var1, Var2	Use the arrows to change the value, tap and use the assigned multipurpose knob to change values, or double-tap to open the virtual keypad to enter a specific value. Available when Math Type = Advanced
Units	Select dBV or Linear units. Available when Math Type = FFT.
Window	Select the window type from the drop-down list. The choices are: Hanning, Rectangular, Hamming, or Blackman-Harris. Available when Math Type = FFT.
Horizontal Scale	Sets the horizontal scale units. Tap the arrows to change the value, tap and use the assigned multipurpose knob to change values, or double-tap to open the virtual keypad to enter a specific value. Available when Math Type = FFT.
Horizontal Position	Sets the horizontal position. Tap the arrows to change the value, tap and use the assigned multipurpose knob to change values, or double-tap to open the virtual keypad to enter a specific value. Available when Math Type = FFT.
Set to 0	Sets the position of the math waveform to zero (center of the screen).

Math waveform guidelines.

- Digital channels and serial buses are not valid in math waveforms.
- You can take measurements on math waveforms in the same way as on channel waveforms.
- Math waveforms derive their horizontal scale and position from the sources in their math expressions. Adjusting these controls for the source waveforms also adjusts the math waveform.
- You can Zoom on math waveforms.

Equation Editor (Math configuration menu)

Use the Equation Editor to build your advanced math waveform expression using sources, operators, constants, measurements, and functions.

To access the math Equation Editor:

1. Double-tap a **Math** waveform badge. If no Math badge is present, tap the **Add Math Ref Bus** button and select **Math** to add a Math waveform and create a Math badge.
2. Double tap the **Math** badge to open the configuration menu.
3. Set Math Type to **Advanced**.
4. Tap **Edit** to open the Equation Editor.

Equation Editor menu fields and controls.

Field or control	Description
Sources	Lists all available sources that you can add to an equation. Tap a source icon to add it to the cursor position in the Math Expression box.
Functions	Select the math functions to apply to your signal or signals. See Add Functions (math Equation Editor) on page 232. Selecting the Meas button opens the Pick Measurement configuration menu.
Keypad	Use to enter numeric and basic math operations.
Miscellaneous	Use to enter logic conditions.
Left/Right arrows	These arrows move the text input bar left/right one function at a time
Bksp	Deletes the character to the left of the cursor.
Clear	Erases the math equation field.
Cancel	Closes the equation editor without saving changes.
OK	Saves changes to the math expression and closes the Equation Editor window.

Equation editor guidelines.

- Use parentheses to group terms in the expression to control execution order, for example, $5*(Ch1 + Ch2)$.

Add Functions (math Equation Editor)

Use the Functions controls to add predefined math operations to your equation.

Button	Description
Intg(Integral. Inserts the text INTG(into the math expression. Enter an argument to the function. The integral function produces the integral of the argument.
Diff(Inserts the text Diff(into the math expression.
Log(Base 10 logarithm. Inserts the text LOG(into the math expression. Enter an argument to the function. The log function produces the base 10 logarithm of the argument.
Exp(Inserts the text Exp(into the math expression.
Sqrt(Inserts the text SQRT(into the math expression. Enter an argument to the function.
Abs(Absolute. Inserts the text ABS(into the math expression. The ABS function takes the absolute value of the expression.
Sine(Inserts the text SIN(into the math expression.
Cosine(Inserts the text COS(into the math expression.
Tangent(Inserts the text TAN(into the math expression.
FFT(FFT Magnitude. Inserts the text Fft(into the math expression. Select one of the waveforms as an argument to the function. This function creates an FFT waveform that shows the magnitude components of the source signal.

Button	Description
Rad(Radians. Inserts the text RAD(into the math expression. The function expresses the value of the expression in Radians.
Deg(Degrees. Inserts the text DEG(into the math expression. The function expresses the value of the expression in degrees.
Trend(Inserts the text Trend(into the math expression.
Var1(Inserts the text Var1(into the math expression.
Var2(Inserts the text Var2(into the math expression.
Meas	Opens the Pick Measurement configuration menu. Selecting a measurement enters the measurement into the math expression and closes the menu. See Pick Measurement on page 233.

Pick Measurement Use the Pick Measurement menu to pick measurement to add to the measurement expression.

To access the Pick Measurement configuration menu:

1. From the math Equation Editor, tap **Meas**. The Pick Measurement configuration menu opens.
2. Select a measurement from the displayed list. Selecting a measurement adds the string to the math expression and closes the menu.

Pick Measurement menu fields and controls.

Field or control	Description
Amplitude	List all available amplitude measurements that you can add to an equation.
Timing	List all available timing measurements that you can add to an equation.
Other	List all available other measurements that you can add to an equation.

Reference waveform configuration menu

Use this menu to configure display settings for a reference waveform.

To open a reference waveform configuration menu, double-tap a **Ref** badge on the Settings bar.

Reference waveform configuration menu fields and controls

Field or control	Description
Display	Turns On or Off displaying the waveform.
Label	<p>Adds a label to the waveform. Tap and enter text using a keyboard, or double-tap to open the virtual keyboard. The label text is the same color as the waveform.</p> <p>Once you have entered the label, close the menu and double-tap the label text to open the Text Settings menu to change the font color, size, and other characteristics.</p>
Vertical Scale	Set the vertical scale by using the assigned multipurpose knob, a virtual keypad, or tap the up or down arrows.
Vertical Position	Set the vertical position of the waveform using the assigned multipurpose knob or the virtual keypad.
Set to 0	Sets the vertical position to 0 (vertical center of the graticule).
Horizontal Scale	Set the horizontal scale by using the assigned multipurpose knob, a virtual keypad, or tap the up or down arrows.
Horizontal Position	Set the horizontal position of the waveform using the assigned multipurpose knob or the virtual keypad.
Set to 0	Sets the horizontal position to 0 (horizontal center of the graticule).
Ref Details	Readout-only text that shows the sample rate and record length values of the reference waveform.

Recall configuration menu (Ref waveform configuration menu)

Use this menu to locate and load a reference waveform file.

Prerequisite: A Ref badge must be present on the Settings bar. See [Add a math, reference, or bus waveform](#) on page 75.

To open the Recall configuration menu:

1. Double-tap a **Ref** badge on the Settings bar.
2. Tap **Recall** to open the Recall configuration menu.

Recall configuration menu (Ref configuration menu) fields and controls

Field or control	Description
Directory structure	<p>The Name column lists the directory structure, opening at the root (/) level. Use to quickly navigate to a file.</p> <p>Tap to list the contents of the directory in the Name pane.</p> <p>Tap the + button to display the directory and any subdirectories under it. Tap the - button to close that directory structure.</p> <p>Drag the scroll bar up and down to show more entries.</p>
+ and -	<p>Use the + and - buttons to navigate the file directory.</p> <p>The - button closes the folder.</p> <p>The + button opens a folder.</p>
Scroll bar	Use the scroll bar to access additional files and folders, when available.
Recall To:	<p>Select which reference waveform location to store the recalled waveform in. Text is included below the buttons that indicates the last time the selected reference was modified.</p> <hr/> <p>NOTE. The oscilloscope can save digital waveforms to .csv files, not reference memories. The oscilloscope cannot recall digital waveforms.</p> <hr/> <p>NOTE. The oscilloscope can save, but not recall, RF acquisitions as .TIQ files. You can use .TIQ files with Tektronix SignalVu Vector Signal Analysis software.</p> <hr/>
OK, Recall Waveform	<p>Recalls the selected file.</p> <p>Recalling a waveform file adds a Reference waveform badge to the Settings bar and displays the waveform as it fits in the current Horizontal setting.</p>

Search configuration menu

Use the Search configuration menu to define conditions that you want to search for on a channel or waveform signal. Each occurrence of the search condition is marked with a triangle along the top of the display.

To open the Search menu, double-tap on the **Search** badge in the Results bar.

If there is no Search badge on the Results bar, tap the Search button. A Search badge is added to the Results bar, and the Search configuration menu opens to search type of Edge (default).

See the following links for information on the search type menus.

[Bus Search configuration menus](#) on page 159

[Edge Search configuration menu](#) on page 175

[Logic Search configuration menu](#) on page 177

[Pulse Width Search configuration menu](#) on page 180

[Rise/Fall Time Search configuration menu](#) on page 182

[Runt Search configuration menu](#) on page 184

[Setup and Hold Search configuration menu](#) on page 185

[Timeout Search configuration menu](#) on page 187

Trigger configuration menu overview

Use the Trigger menu to define the channel or waveform signal conditions on which to trigger the oscilloscope. The trigger event establishes the time-reference point in the waveform record. All waveform record data is located in time with respect to the trigger point.

To access the Trigger menu, double-tap the Trigger badge on the Settings bar. The Trigger menu opens to show the current trigger settings.

- Trigger types**
- [Edge Trigger menu](#)
 - [Pulse Width Trigger menu](#)
 - [Timeout Trigger menu](#)
 - [Runt Trigger menu](#)
 - [Logic Trigger menu](#)
 - [Setup & Hold Trigger menu](#)
 - [Rise/Fall Time Trigger menu](#)
 - [Video Trigger menu](#)
 - [Bus Trigger menu](#)
 - [Sequence Trigger menu](#)

Bus Trigger configuration Use the Bus trigger menus to trigger on bus-related events (Start, Stop, Missing Ack, Address, Data, and so on).

NOTE. You must add a bus to the Waveform view before you can trigger on it. [Add a math, reference, or bus waveform on page 75.](#)

To open the Bus trigger menu:

1. Double-tap the **Trigger** badge on the Settings bar.
2. Set the **Trigger Type** to **Bus**.
3. Select the bus on which to trigger in the **Source** field.

Use the following links to access trigger settings for specific buses.

[ARINC429 serial bus trigger settings panel](#) on page 238

[Audio serial bus trigger settings panel](#) on page 240

[CAN serial bus trigger settings panel](#) on page 241

[FlexRay serial bus trigger settings panel](#) on page 242

[I2C serial bus trigger settings panel](#) on page 245

[LIN serial bus trigger settings panel](#) on page 247

[MIL-STD-1553 serial bus trigger settings panel](#) on page 248

[Parallel serial bus trigger settings panel](#) on page 250

[RS-232 serial bus trigger settings panel](#) on page 251

[SPI serial bus trigger settings panel](#) on page 252

[USB serial bus trigger settings panel](#) on page 253

Trigger types.

- [Edge Trigger menu](#)
- [Pulse Width Trigger menu](#)
- [Timeout Trigger menu](#)
- [Runt Trigger menu](#)
- [Logic Trigger menu](#)
- [Setup & Hold Trigger menu](#)
- [Rise/Fall Time Trigger menu](#)
- [Video Trigger menu](#)
- [Bus Trigger menu](#)
- [Sequence Trigger menu](#)

ARINC429 serial bus trigger settings panel

Use the ARINC429 bus menu (optional) to set up and decode a ARINC429 avionics network serial data bus waveform

NOTE. Requires option SRAERO.

Field or control	Description
Source	Select the ARINC429 bus on which you want to trigger.
Trigger On	Select the type of information on which to trigger.
Error Type	Sets the error condition on which to trigger. Available when Trigger On = Error .
Trigger When	Sets the condition on which to trigger. Available when Trigger On = Label .
Label	Sets the label pattern on which to trigger. Tap the Binary , Hex , or Octal field and use the A and B knobs to select and change the values. Or double-tap on the field and use the virtual keypad to enter values. Available when Trigger On = Label & Data or Trigger When = any condition except Inside Range or Outside Range .
Label Low	Sets the low value of the label pattern range on which to trigger. Tap the Binary , Hex , or Octal field and use the A and B knobs to select and change the values. Or double-tap on the field and use the virtual keypad to enter values. Available when Trigger When = Inside Range or Outside Range .
Label High	Sets the high value of the label pattern range on which to trigger. Tap the Binary , Hex , or Octal field and use the A and B knobs to select and change the values. Or double-tap on the field and use the virtual keypad to enter values. Available when Trigger When = Inside Range or Outside Range .
SSM	Sets to trigger when the specified Sign/Status Matrix (SSM) bit condition occurs. Tap the Binary or Hex field and use the A and B knobs to select and change the values. Or double-tap on the field and use the virtual keypad to enter values. Available when Trigger On = Data and the Data Format is set to Data (19 bits) or SDI+Data (21 bits) .

Field or control	Description
SDI	<p>Sets to trigger when the specified Source/Destination Identifier (SDI) bit condition occurs.</p> <p>Tap the Binary or Hex field and use the A and B knobs to select and change the values. Or double-tap on the field and use the virtual keypad to enter values.</p> <p>Available when Trigger On = Data and the Data Format is set to Data (19 bits).</p>
Trigger When Data	<p>Sets the condition on which to trigger.</p> <p>Available when Trigger On = Label & Data.</p>
Data	<p>Sets to trigger when the specified data bits condition occurs.</p> <p>Tap the Binary or Hex field and use the A and B knobs to select and change the values. Or double-tap on the field and use the virtual keypad to enter values. See Binary, decimal, hex, and octal virtual keypads on page 274.</p> <p>Available when Trigger When = anything except Inside Range or Outside Range.</p>
Data High	<p>Sets the high value of the data pattern range on which to trigger.</p> <p>Tap the Binary, Hex, or Octal field and use the A and B knobs to select and change the values. Or double-tap on the field and use the virtual keypad to enter values.</p> <p>Available when Trigger When = Inside Range or Outside Range.</p>
Data Low	<p>Sets the low value of the data pattern range on which to trigger.</p> <p>Tap the Binary, Hex, or Octal field and use the A and B knobs to select and change the values. Or double-tap on the field and use the virtual keypad to enter values.</p> <p>Available when Trigger When = Inside Range or Outside Range.</p>
A, B knob controls	<p>Use the A knob to select (highlight) the digit(s) to change in data or bit fields.</p> <p>Use the B knob to change the value of the digit(s) in the selected field.</p>
Mode & Holdoff	<p>Trigger Mode determines how the instrument behaves in the absence or presence of a trigger event.</p> <p>Holdoff sets the amount of time the oscilloscope waits after a trigger event before detecting and triggering on the next trigger event.</p> <p>For additional information on Trigger Mode, Holdoff, forcing a trigger, and the Trigger Frequency Counter see Mode and Holdoff panel on page 271.</p>
Act On Trigger	<p>Set the actions the instrument takes when a trigger event occurs.</p> <p>For additional information on the Act On Trigger panel see Act On Trigger configuration menu on page 273.</p>

Audio serial bus trigger settings panel

Use the Audio bus menu (optional) to set up and display Audio Type I2S, Left Justified (LJ), Right Justified (RJ), or TDM Audio serial bus waveforms.

NOTE. Requires option *SRAUDIO*.

Field or control	Description
Source	Select the Audio bus on which to trigger.
Trigger On	Select the type of information on which to trigger.
Word	Sets the audio word channel on which to trigger (Either, Left, Right). Available when Trigger On = Data .
Channel	Sets the audio channel on which to trigger. Available when Trigger On = Data and the Audio bus is TDM.
Trigger When	Sets the trigger when condition for the specified data pattern. When set to Inside Range or Outside Range , fields are displayed to set a high and low boundary pattern for the specified trigger type. Tap the Binary, Hex, or Decimal field and use the A and B knobs to select and change the values. Or double-tap on the field and use the virtual keypad to enter values. Available when Trigger On = Data .
Data	Sets the data pattern on which to trigger. Use in conjunction with the Trigger When field to specify the exact trigger condition. Tap the Binary, Hex, or Decimal field and use the A and B knobs to select and change the values. Or double-tap on the field and use the virtual keypad to enter values. See Binary, decimal, hex, and octal virtual keypads on page 274. Available when Trigger When ≠ Inside Range or Outside Range .
Data High	Sets the data high pattern which, if exceeded, will cause a trigger. Tap the Binary, Hex, or Decimal field and use the A and B knobs to select and change the values. Or double-tap on the field and use the virtual keypad to enter values. Available when Trigger When = Inside Range or Outside Range .
Data Low	Sets the data low pattern which, if exceeded, will cause a trigger. Tap the Binary, Hex, or Decimal field and use the A and B knobs to select and change the values. Or double-tap on the field and use the virtual keypad to enter values. Available when Trigger When = Inside Range or Outside Range .

Field or control	Description
A, B knob controls	Use the A knob to select (highlight) the digit(s) to change. Use the B knob to change the value of the digit(s).
Mode & Holdoff	Trigger Mode determines how the instrument behaves in the absence or presence of a trigger event. Holdoff sets the amount of time the oscilloscope waits after a trigger event before detecting and triggering on the next trigger event. For additional information on Trigger Mode, Holdoff, forcing a trigger, and the Trigger Frequency Counter see Mode and Holdoff panel on page 271.
Act On Trigger	Set the actions the instrument takes when a trigger event occurs. For additional information on the Act On Trigger panel see Act On Trigger configuration menu on page 273.

CAN serial bus trigger settings panel

Use the CAN bus menu (optional) to set up and display a CAN (Controller Area Network) serial bus waveform.

NOTE. Requires option *SRAUTO*.

Field or control	Description
Source	Select the CAN bus on which you want to trigger.
Trigger On	Select the type of information on which to trigger.
Frame Type	Sets the frame type on which to trigger. Available when Trigger On = Type of Frame .
FD BRS Bit	Sets the FD BRS or EIS bit to X, 0, or 1. Available when Source is a CAN FD bus and Trigger On = FD BRS Bit .
FD ESI Bit	Sets the FD BRS or EIS bit to X, 0, or 1. Available when Source is a CAN FD bus and Trigger On = FD ESI Bits .
Trigger When Data	Select the Trigger When Data condition from the drop down list. Available when Trigger On = Data or Identifier & Data .
Identifier Format	Sets the identifier for standard (11-bit) or extended (29-bit for CAN 2.0B) length. Available when Trigger On = Identifier or Identifier & Data .
Data Bytes	Sets the number of data bytes on which to trigger (one to eight bytes). Use the A knob to change the value. Available when Trigger On = Data or Identifier & Data .
Data Offset	Sets the data offset in bytes to delay the trigger. Available when Trigger On = Data or Identifier & Data .

Field or control	Description
Identifier	<p>Sets the identifier pattern on which to trigger. The number of bits shown depends on the Identifier Format setting.</p> <p>Tap the Binary or Hex field and use the A and B knobs to select and change the values. Or double-tap on the field and use the virtual keypad to enter values.</p> <p>Available when Trigger On = Identifier or Identifier & Data.</p>
Data	<p>Sets the data pattern on which to trigger. The number of bits shown depends on the Data Bytes setting.</p> <p>Tap the Binary or Hex field and use the A and B knobs to select and change the values. Or double-tap on the field and use the virtual keypad to enter values. See Binary, decimal, hex, and octal virtual keypads on page 274.</p> <p>Available when Trigger On = Data or Identifier & Data.</p>
A, B knob controls	<p>Use the A knob to select (highlight) the digit(s) to change.</p> <p>Use the B knob to change the value of the digit(s).</p>
Mode & Holdoff	<p>Trigger Mode determines how the instrument behaves in the absence or presence of a trigger event.</p> <p>Holdoff sets the amount of time the oscilloscope waits after a trigger event before detecting and triggering on the next trigger event.</p> <p>For additional information on Trigger Mode, Holdoff, forcing a trigger, and the Trigger Frequency Counter see Mode and Holdoff panel on page 271.</p>
Act On Trigger	<p>Set the actions the instrument takes when a trigger event occurs.</p> <p>For additional information on the Act On Trigger panel see Act On Trigger configuration menu on page 273.</p>

FlexRay serial bus trigger settings panel

Use the Flexray bus menu (optional) to set up and display a Flexray automotive network serial bus waveform.

NOTE. Requires option *SRAUTO*.

Field or control	Description
Source	Select the FlexRay bus on which to trigger.
Trigger On	Select the type of information on which to trigger: Start of Frame, Indicator Bits, Identifier, Cycle Count, Header Fields, Data, Identifier & Data, End of Frame, or an Error.
Indicator Bits	<p>Select the indicator bits type on which to trigger: Normal (01XX), Payload (11XX), Null (00XX), Sync (XX10), or Startup (XX11).</p> <p>Available when Trigger On = Indicator Bits.</p>

Field or control	Description
Frame Type	<p>Sets the end of frame type on which to trigger (Static, Dynamic (DTS), ALL).</p> <p>Available when Trigger On = End of Frame.</p>
Error Type	<p>Sets the error type on which to trigger: Header CRC; Trailer CRC; Null Frame, Static; Null Frame, Dynamic; Sync Frame; or Startup Frame (No Sync).</p> <p>Available when Trigger On = Error.</p>
Trigger When	<p>Sets the trigger when condition.</p> <p>When set to Inside Range or Outside Range, fields are displayed to set a high and low boundary pattern for the specified trigger type.</p> <p>Available when Trigger On = Identifier or Cycle Count.</p>
Identifier	<p>Sets the frame identifier pattern on which to trigger.</p> <p>Tap the Binary, Hex, or Dec field and use the A and B knobs to select and change the values. Or double-tap on the field and use the virtual keypad to enter values.</p> <p>Available when Trigger On = Identifier, Identifier & Data, or Header and Trigger When Data is not set to Inside Range or Outside Range.</p>
Identifier High	<p>Sets the frame identifier high pattern which, if exceeded, will cause a trigger.</p> <p>Available when Trigger On = Identifier and Trigger When Data is set to Inside Range or Outside Range.</p>
Identifier Low	<p>Sets the frame identifier low pattern which, if exceeded, will cause a trigger.</p> <p>Available when Trigger On = Identifier and Trigger When Data is set to Inside Range or Outside Range.</p>
Cycle Count	<p>Sets the cycle count pattern on which to trigger. Use in conjunction with the Trigger When field to specify the exact trigger condition.</p> <p>Tap the Binary, Hex, or Decimal field and use the A and B knobs to select and change the values. Or double-tap on the field and use the virtual keypad to enter values.</p> <p>Available when Trigger On = Cycle Count or Header Fields and Trigger When Data is not set to Inside Range or Outside Range.</p>
Cycle Count High	<p>Sets the cycle count high limit which, if exceeded, will cause a trigger.</p> <p>Available when Trigger On = Cycle Count and Trigger When Data is set to Inside Range or Outside Range.</p>
Cycle Count Low	<p>Sets the cycle count low limit which, if exceeded, will cause a trigger.</p> <p>Available when Trigger On = Cycle Count and Trigger When Data is set to Inside Range or Outside Range.</p>

Field or control	Description
Indicator Bits	<p>Sets the indicator bits on which to trigger.</p> <p>Tap the Binary, Hex, or Decimal field and use the A and B knobs to select and change the values. Or double-tap on the field and use the virtual keypad to enter values.</p> <p>Available when Trigger On = Header Fields .</p>
Payload Length	<p>Select the Binary, Hex, or Decimal field and use the A and B knobs to select and change the values. Or double-tap on the field and use the virtual keypad to enter values.</p> <p>Available when Trigger On = Header Fields.</p>
Header CRC	<p>Select the Binary or Hex field and use the A and B knobs to select and change the values. Or double-tap on the field and use the virtual keypad to enter values.</p> <p>Available when Trigger On = Header Fields.</p>
Trigger When Data	<p>Sets the trigger when data condition.</p> <p>When set to Inside Range or Outside Range, fields are displayed to set a high and low boundary pattern for the specified trigger type.</p> <p>Available when Trigger On = Identifier or Identifier & Data.</p>
Data Bytes	<p>Sets the number of data bytes on which to trigger (one to sixteen bytes). Use the A knob to change the value. Or double-tap on the field and use the virtual keypad to enter values.</p> <p>Available when Trigger On = Data or Identifier & Data.</p>
Data Offset	<p>Sets the data offset (Don't Care or the number of bytes). Tap the input box and use the A knob to change the value.</p> <p>Available when Trigger On = Data or Identifier & Data.</p>
Data	<p>Sets the data pattern on which to trigger. The number of bits shown depends on the Data Bytes setting. Use in conjunction with the Trigger When field to specify the exact trigger condition.</p> <p>Tap the Binary or Hex field and use the A and B knobs to select and change the values. Or double-tap on the field and use the virtual keypad to enter values. See Binary, decimal, hex, and octal virtual keypads on page 274.</p> <p>Available when Trigger On = Data or Identifier & Data and Trigger When Data is not set to Inside Range or Outside Range.</p>

Field or control	Description
Data High	<p>Sets the data high pattern which, if exceeded, will cause a trigger.</p> <p>Tap the Binary or Hex field and use the A and B knobs to select and change the values. Or double-tap on the field and use the virtual keypad to enter values.</p> <p>Available when Trigger On = Data or Identifier & Data and Trigger When Data is set to Inside Range or Outside Range.</p>
Data Low	<p>Sets the data low pattern which, if exceeded, will cause a trigger.</p> <p>Tap the Binary or Hex field and use the A and B knobs to select and change the values. Or double-tap on the field and use the virtual keypad to enter values.</p> <p>Available when Trigger On = Data or Identifier & Data and Trigger When Data is set to Inside Range or Outside Range.</p>
A, B knob controls	<p>Use the A knob to select (highlight) the digit(s) to change.</p> <p>Use the B knob to change the value of the digit(s).</p>
Mode & Holdoff	<p>Trigger Mode determines how the instrument behaves in the absence or presence of a trigger event.</p> <p>Holdoff sets the amount of time the oscilloscope waits after a trigger event before detecting and triggering on the next trigger event.</p> <p>For additional information on Trigger Mode, Holdoff, forcing a trigger, and the Trigger Frequency Counter see Mode and Holdoff panel on page 271.</p>
Act On Trigger	<p>Set the actions the instrument takes when a trigger event occurs.</p> <p>For additional information on the Act On Trigger panel see Act On Trigger configuration menu on page 273.</p>

I2C serial bus trigger settings panel

Use the I2C bus menu (optional) to set up and display an I²C (Inter-Integrated Circuit) serial bus waveform.

NOTE. Requires option SREMBD.

Field or control	Description
Source	Select the I²C bus on which to trigger.
Trigger On	Select the type of information on which to trigger.
Direction	<p>Sets the transfer direction on which to trigger (Read, Write, Either).</p> <p>Available when Trigger On = Address or Address & Data.</p>
Addressing Mode	<p>Sets the slave device address length (7 bits or 10 bits long).</p> <p>Available when Trigger On = Address or Address & Data.</p>

Field or control	Description
Address	<p>Sets the address pattern on which to trigger. The number of bits shown depends on the Address Mode setting.</p> <p>Tap the Binary or Hex field and use the A and B knobs to select and change the values. Or double-tap on the field and use the virtual keypad to enter values.</p> <p>Available when Trigger On = Address or Address & Data.</p>
Data Bytes	<p>Sets the number of data bytes on which to trigger (one to five bytes). Use the A knob to change the value.</p> <p>Available when Trigger On = Data or Address & Data.</p>
Data	<p>Sets the data pattern on which to trigger. The number of bits shown depends on the Data Bytes setting.</p> <p>Tap the Binary or Hex field and use the A and B knobs to select and change the values. Or double-tap on the field and use the virtual keypad to enter values. See Binary, decimal, hex, and octal virtual keypads on page 274.</p> <p>Available when Trigger On = Data or Address & Data.</p>
A, B knob controls	<p>Use the A knob to select (highlight) the digit(s) to change.</p> <p>Use the B knob to change the value of the digit(s). Or double-tap on the field and use the virtual keypad to enter values.</p>
Mode & Holdoff	<p>Trigger Mode determines how the instrument behaves in the absence or presence of a trigger event.</p> <p>Holdoff sets the amount of time the oscilloscope waits after a trigger event before detecting and triggering on the next trigger event.</p> <p>For additional information on Trigger Mode, Holdoff, forcing a trigger, and the Trigger Frequency Counter see Mode and Holdoff panel on page 271.</p>
Act On Trigger	<p>Set the actions the instrument takes when a trigger event occurs.</p> <p>For additional information on the Act On Trigger panel see Act On Trigger configuration menu on page 273.</p>

LIN serial bus trigger settings panel

Use this menu (optional) to set up and display a LIN (Local Interconnect Network) serial bus waveform.

NOTE. Requires option *SRAUTO*.

Field or control	Description
Source	Select the LIN bus on which to trigger.
Trigger On	Select the type of information on which to trigger.
Identifier	<p>Sets the identifier pattern on which to trigger.</p> <p>Tap the Binary, Hex, or Dec field and use the A and B knobs to select and change the values. Or double-tap on the field and use the virtual keypad to enter values.</p> <p>Available when Trigger On = Identifier or Identifier & Data.</p>
Trigger When Data	<p>Sets the trigger when condition.</p> <p>When set to Inside Range or Outside Range, fields are displayed to set a high and low boundary pattern for the specified trigger type.</p> <p>Available when Trigger On = Data or Identifier & Data.</p>
Data Bytes	<p>Sets the number of data bytes on which to trigger (one to eight bytes). Use the A knob to change the value.</p> <p>Available when Trigger On = Data or Identifier & Data.</p>
Data	<p>Sets the data pattern on which to trigger. The number of bits shown depends on the Data Bytes setting.</p> <p>Tap the Binary or Hex field and use the A and B knobs to select and change the values. Or double-tap on the field and use the virtual keypad to enter values. See Binary, decimal, hex, and octal virtual keypads on page 274.</p> <p>Available when Trigger On = Data or Identifier & Data and Trigger When Data is not set to Inside Range or Outside Range.</p>
Data High	<p>Sets the data pattern high limit which, if exceeded, will cause a trigger. Available when Trigger On = Data or Identifier & Data and Trigger When Data is set to Inside Range or Outside Range.</p>
Data Low	<p>Sets the data pattern low limit which, if exceeded, will cause a trigger. Available when Trigger On = Data or Identifier & Data and Trigger When Data is set to Inside Range or Outside Range.</p>
Error Type	<p>Sets the LIN error type on which to trigger.</p> <p>Available when Trigger On = Error.</p>
A, B knob controls	<p>Use the A knob to select (highlight) the digit(s) to change.</p> <p>Use the B knob to change the value of the digit(s). Or double-tap on the field and use the virtual keypad to enter values.</p>

Field or control	Description
Mode & Holdoff	Trigger Mode determines how the instrument behaves in the absence or presence of a trigger event. Holdoff sets the amount of time the oscilloscope waits after a trigger event before detecting and triggering on the next trigger event. For additional information on Trigger Mode, Holdoff, forcing a trigger, and the Trigger Frequency Counter see Mode and Holdoff panel on page 271.
Act On Trigger	Set the actions the instrument takes when a trigger event occurs. For additional information on the Act On Trigger panel see Act On Trigger configuration menu on page 273.

MIL-STD-1553 serial bus trigger settings panel

Use the MIL-STD-1553 bus menu (optional) to set up and decode a MIL-STD-1553 aeronautic network serial data bus waveform.

NOTE. Requires option *SRAERO*.

Field or control	Description
Source	Select the MIL-STD-1553 bus on which you want to trigger.
Trigger On	Select the type of information on which to trigger.
Error Type	Sets the error condition on which to trigger. Available when Trigger On = Error .
Parity	Sets to trigger on the selected parity bit logic state. Available when Trigger On = Command, Status, or Data .
Data	Sets the data pattern on which to trigger. Available when Trigger On = Data .
Trigger When	Sets to trigger when the specified RT/IMG signal time condition occurs. Available when Trigger On = Time (RT/IMG) .
Maximum Time	Sets the maximum time for a valid RT/IMG signal. Available when Trigger On = Time (RT/IMG) .
Minimum Time	Sets the minimum time for a valid RT/IMG signal. Available when Trigger On = Time (RT/IMG) .
Transmit/Receive Bit	Sets the transmit or receive bit on which to trigger. Available when Trigger On = Command .
Trigger When RT Address	Sets to trigger when the specified RT address condition occurs. Available when Trigger On = Command or Status .

Field or control	Description
Parity	<p>Sets to trigger when the specified parity condition occurs.</p> <p>Available when Trigger On = Command or Status.</p>
Address	<p>Sets the address pattern on which to trigger.</p> <p>Tap the Binary, Hex, or Dec field and use the A and B knobs to select and change the values. Or double-tap on the field and use the virtual keypad to enter values.</p> <p>Available when Trigger When RT Address = anything but Inside Range or Outside Range.</p>
High Address	<p>Sets the high address of the address pattern range on which to trigger.</p> <p>Tap the Binary, Hex, or Dec field and use the A and B knobs to select and change the values. Or double-tap on the field and use the virtual keypad to enter values.</p> <p>Available when Trigger When RT Address = Inside Range or Outside Range.</p>
Low Address	<p>Sets the low value of the address pattern range on which to trigger.</p> <p>Tap the Binary, Hex, or Dec field and use the A and B knobs to select and change the values. Or double-tap on the field and use the virtual keypad to enter values.</p> <p>Available when Trigger When RT Address = Inside Range or Outside Range.</p>
Subaddress/Mode	<p>Sets the subaddress or mode pattern on which to trigger.</p> <p>Tap the Binary, Hex, or Dec field and use the A and B knobs to select and change the values. Or double-tap on the field and use the virtual keypad to enter values.</p> <p>Available when Trigger On = Command.</p>
Word Count/Mode Code	<p>Sets the word count or mode code on which to trigger.</p> <p>Tap the Binary, Hex, or Dec field and use the A and B knobs to select and change the values. Or double-tap on the field and use the virtual keypad to enter values.</p> <p>Available when Trigger On = Command.</p>
Status Word Bits	<p>Sets the status word pattern on which to trigger.</p> <p>Tap the Binary, Hex, or Dec field and use the A and B knobs to select and change the values. Selecting a bit shows a short description of that bit's function. Or double-tap on the field and use the virtual keypad to enter values.</p> <p>Available when Trigger On = Status.</p>

Field or control	Description
A, B knob controls	Use the A knob to select (highlight) the digit(s) to change in data or bit fields. Use the B knob to change the value of the digit(s). Or double-tap on the field and use the virtual keypad to enter values.
Mode & Holdoff	Trigger Mode determines how the instrument behaves in the absence or presence of a trigger event. Holdoff sets the amount of time the oscilloscope waits after a trigger event before detecting and triggering on the next trigger event. For additional information on Trigger Mode, Holdoff, forcing a trigger, and the Trigger Frequency Counter see Mode and Holdoff panel on page 271.
Act On Trigger	Set the actions the instrument takes when a trigger event occurs. For additional information on the Act On Trigger panel see Act On Trigger configuration menu on page 273.

Parallel serial bus trigger settings panel

Use this menu to set up and display a parallel bus waveform.

NOTE. *Parallel bus triggering is standard on all instruments.*

Field or control	Description
Source	Select the type of information on which to trigger.
Data	Sets the data pattern on which to trigger. The number of bits shown depends on how the parallel bus is defined. Tap the Binary or Hex field and use the A and B knobs to select and change the values. Or double-tap on the field and use the virtual keypad to enter values. See Binary, decimal, hex, and octal virtual keypads on page 274.
A, B knob controls	Use the A knob to select (highlight) the digit(s) to change. Use the B knob to change the value of the digit(s).
Mode & Holdoff	Trigger Mode determines how the instrument behaves in the absence or presence of a trigger event. Holdoff sets the amount of time the oscilloscope waits after a trigger event before detecting and triggering on the next trigger event. For additional information on Trigger Mode, Holdoff, forcing a trigger, and the Trigger Frequency Counter see Mode and Holdoff panel on page 271.
Act On Trigger	Set the actions the instrument takes when a trigger event occurs. For additional information on the Act On Trigger panel see Act On Trigger configuration menu on page 273.

RS-232 serial bus trigger settings panel

Use this menu (optional) to set up and display an RS232 serial bus waveform.

NOTE. Requires option *SRCOMP*.

Field or control	Description
Source	Select the RS-232 bus on which to trigger.
Trigger On	Select the type of information on which to trigger.
Data Bytes	<p>Sets the number of data bytes (1 byte = 8 bits) on which to trigger (one to ten bytes). Use the A knob to change the value.</p> <p>Available when Trigger On = Rx Data or Tx Data.</p>
Data	<p>Sets the data pattern on which to trigger. The number of bits shown depends on the Data Words setting.</p> <p>Tap the Binary, Hex, or ASCII field and use the A and B knobs to select and change the values. Or double-tap on the field and use the virtual keypad to enter values. See Binary, decimal, hex, and octal virtual keypads on page 274.</p> <p>Available when Trigger On = Rx Data or Tx Data.</p>
A, B knob controls	<p>Use the A knob to select (highlight) the digit(s) to change.</p> <p>Use the B knob to change the value of the digit(s).</p>
Mode & Holdoff	<p>Trigger Mode determines how the instrument behaves in the absence or presence of a trigger event.</p> <p>Holdoff sets the amount of time the oscilloscope waits after a trigger event before detecting and triggering on the next trigger event.</p> <p>For additional information on Trigger Mode, Holdoff, forcing a trigger, and the Trigger Frequency Counter see Mode and Holdoff panel on page 271.</p>
Act On Trigger	<p>Set the actions the instrument takes when a trigger event occurs.</p> <p>For additional information on the Act On Trigger panel see Act On Trigger configuration menu on page 273.</p>

SPI serial bus trigger settings panel

Use the SPI bus menu (optional) to set up and display an SPI (Serial Peripheral Interface) synchronous serial bus waveform.

NOTE. Requires option SREMBD.

Field or control	Description
Source	Select the SPI bus on which you want to trigger.
Trigger On	Select the type of information on which to trigger.
Data Bytes	Sets the number of data bytes on which to trigger (one to sixteen bytes). Use the A knob to change the value. Available when Trigger On = MOSI, MISO, or MOSI & MISO.
MOSI	Sets the data pattern on which to trigger. Double touch to open the editor to set the pattern. Available when Trigger On = MOSI, or MOSI & MISO.
MISO	Sets the data pattern on which to trigger. Double touch to open the editor to set the pattern. Available when Trigger On = MISO, or MOSI & MISO.
A, B knob controls	Use the A knob to select (highlight) the digit(s) to change. Use the B knob to change the value of the digit(s).
Mode & Holdoff	Trigger Mode determines how the instrument behaves in the absence or presence of a trigger event. Holdoff sets the amount of time the oscilloscope waits after a trigger event before detecting and triggering on the next trigger event. For additional information on Trigger Mode, Holdoff, forcing a trigger, and the Trigger Frequency Counter see Mode and Holdoff panel on page 271.
Act On Trigger	Set the actions the instrument takes when a trigger event occurs. For additional information on the Act On Trigger panel see Act On Trigger configuration menu on page 273.

USB serial bus trigger settings panel

Use the USB bus menu (optional) to set up and display an USB 2.0 (Universal Serial Bus) waveform.

NOTE. Requires option *SRUSB2*.

Field or control	Description
Source	Select the USB bus on which to trigger.
Trigger On	Select the type of information on which to trigger: Sync, Reset, Suspend, Resume, End of Packet, Token Packet, Data Packet, Handshake Packet, Special Packet, or Error.
Trigger When	<p>Sets the trigger when condition.</p> <p>When set to Inside Range or Outside Range, fields are displayed to set a high and low boundary pattern for the specified trigger type.</p> <p>Tap the Binary or Hex field and use the A and B knobs to select and change the values. Or double-tap on the field and use the virtual keypad to enter values.</p> <p>Available when Trigger On = Handshake Packet, Data Packet, Error, Special Packet, or when Trigger On is set to Token Packet and Token Type is set to anything but SOF (0101) .</p>
Token Type	<p>Sets the token packet type on which to trigger.</p> <p>Available when Trigger On = Token Packet.</p>
Endpoint	<p>Sets the token packet endpoint pattern on which to trigger.</p> <p>Use in conjunction with the Trigger When field to specify the exact trigger condition.</p> <p>Tap the Binary, Hex, or Decimal field and use the A and B knobs to select and change the values. Or double-tap on the field and use the virtual keypad to enter values.</p> <p>Available when Trigger On = Token Packet and Token Type = all except SOF (0101).</p>
Handshake Type	<p>Sets the handshake packet type on which to trigger.</p> <p>Available when Trigger On = Handshake Packet.</p>
Packet Type	<p>Sets the special packet type on which to trigger.</p> <p>Available when Trigger On = Special Packet.</p>
Error Type	<p>Sets the error type on which to trigger.</p> <p>Available when Trigger On = Error.</p>

Field or control	Description
Address	<p>Sets the token packet address pattern on which to trigger. Use in conjunction with the Trigger When field to specify the exact trigger condition.</p> <p>Tap the Binary, Hex, or Decimal field and use the A and B knobs to select and change the values. Or double-tap on the field and use the virtual keypad to enter values.</p> <p>Available when Trigger When \neq Inside Range or Outside Range.</p>
Address Low, Address High	<p>Sets the boundary address conditions when testing for in-range or out of range conditions.</p> <p>Available when Trigger When = Inside Range or Outside Range.</p>
Frame Number	<p>Sets the frame number on which to trigger. Use in conjunction with the Trigger When field to specify the exact trigger condition.</p> <p>Tap the Binary, Hex, or Dec field and use the A and B knobs to select and change the values. Or double-tap on the field and use the virtual keypad to enter values.</p> <p>Available when Trigger When = Token Packet and Token Type = SOF (0101).</p>
Data Packet Type	<p>Sets the data packet type on which to trigger.</p> <p>Available when Trigger On = Data Packet.</p>
Data Bytes	<p>Sets the number of data bytes on which to trigger (one to two bytes). Tap the field and use the A knob to change the value.</p> <p>Available when Trigger On = Data Packet.</p>
Byte Offset	<p>Sets the byte offset (Don't Care or the number of bytes). Tap the field and use the A knob to change the value.</p> <p>Available when Trigger On = Data Packet.</p>
Data	<p>Sets the data packet pattern on which to trigger. The number of bits shown depends on the Data Bytes setting. Use in conjunction with the Trigger When field to specify the exact trigger condition.</p> <p>Tap the Binary, Hex, or ASCII field and use the A and B knobs to select and change the values. Or double-tap on the field and use the virtual keypad to enter values. See Binary, decimal, hex, and octal virtual keypads on page 274.</p> <p>Available when Trigger On = Data Packet and Trigger When = anything but Inside Range or Outside Range.</p>
Data Low, Data High	<p>Sets the boundary data conditions when testing for in-range or out of range conditions.</p> <p>Available when Trigger When = Inside Range or Outside Range.</p>

Field or control	Description
A, B knob controls	Use the A knob to select (highlight) the digit(s) to change. Use the B knob to change the value of the digit(s).
Mode & Holdoff	Trigger Mode determines how the instrument behaves in the absence or presence of a trigger event. Holdoff sets the amount of time the oscilloscope waits after a trigger event before detecting and triggering on the next trigger event. For additional information on Trigger Mode, Holdoff, forcing a trigger, and the Trigger Frequency Counter see Mode and Holdoff panel on page 271.
Act On Trigger	Set the actions the instrument takes when a trigger event occurs. For additional information on the Act On Trigger panel see Act On Trigger configuration menu on page 273.

Edge Trigger configuration menu

Use the Edge Trigger menu to trigger the oscilloscope when a signal rises and/or falls through a specified level.

To open the Edge trigger menu:

1. Double-tap the **Trigger** badge on the Settings bar.
2. Set the **Trigger Type** to **Edge**.

Settings panel (Edge Trigger configuration menu) fields and controls.

Field or control	Description
Trigger Type	Set to Edge .
Source	Lists the source channel or waveform to use to trigger.
Coupling	<p>Set the conditioning to apply to the source signal trigger circuit from the source signal.</p> <p>DC coupling passes all input signals directly to the trigger circuitry.</p> <p>AC coupling blocks the DC component and shows only the AC signal.</p> <p>HF Reject coupling attenuates signals above 50 kHz before passing the signal to the trigger circuitry.</p> <p>LF Reject coupling attenuates signals below 50 kHz before passing the signal to the trigger circuitry.</p> <p>Noise Reject coupling provides stable triggering by increasing the trigger hysteresis. Increased hysteresis reduces the trigger sensitivity to noise so may require greater signal amplitude.</p>
Level	Sets the amplitude level that the signal must pass through to be considered a valid transition.
Set to 50%	Sets the threshold at 50% of the measured signal transition range. 50% is calculated as $(Top + Bottom)/2$.
Slope	Sets the signal transition direction to detect. (rising, falling, or either direction).
Mode & Holdoff	<p>Trigger Mode determines how the instrument behaves in the absence or presence of a trigger event.</p> <p>Holdoff sets the amount of time the oscilloscope waits after a trigger event before detecting and triggering on the next trigger event.</p> <p>For additional information on Trigger Mode, Holdoff, forcing a trigger, and the Trigger Frequency Counter see Mode and Holdoff panel on page 271.</p>
Act On Trigger	<p>Set the actions the instrument takes when a trigger event occurs.</p> <p>For additional information on the Act On Trigger panel see Act On Trigger configuration menu on page 273.</p>

Trigger types.

- *Edge Trigger menu*
- *Pulse Width Trigger menu*
- *Timeout Trigger menu*
- *Runt Trigger menu*
- *Logic Trigger menu*
- *Setup & Hold Trigger menu*
- *Rise/Fall Time Trigger menu*
- *Video Trigger menu*
- *Bus Trigger menu*
- *Sequence Trigger menu*

Logic Trigger configuration menu

Use the Logic trigger to trigger the oscilloscope when the specified logic conditions occur on any combination of analog and digital inputs. The logic conditions include the state of each input, the condition to test (inputs go true, false, or are within a time limit), and the Boolean function of the inputs.

To open the Logic Trigger menu:

1. Double-tap the **Trigger** badge on the Settings bar.
2. Set the **Trigger Type** to **Logic**.

Settings panel (Logic Trigger configuration menu) - fields and controls.

Field or control	Description
Use Clock Edge?	Enables or disables finding logic patterns that occur on the specified clock edge.
Logic Pattern Define Inputs	Opens the Logic Trigger - Define Inputs menu where you define the logic state (High , Low , or Don't Care), and the signal threshold level that defines the logic state (high or low), for each analog or digital signal. See Logic Trigger - Define Inputs configuration menu on page 259.
Trigger When (Use Clock Edge = No)	Defines the waveform condition on which to trigger. <ul style="list-style-type: none"> ■ Goes True: All conditions change to a true state. ■ Goes False: All conditions change to a false state. ■ Is True > Limit: Condition remains true longer than a specified time. ■ Is True < Limit: Condition remains true for less than a specified time. ■ Is True = Limit: Condition remains true for a specified time (within $\pm 5\%$). ■ Is True \neq Limit: Condition does not remain true for a specified time (within $\pm 5\%$).
Clock Source (Use Clock Edge = Yes)	Sets the signal to use as the clock. The clock signal can be a digital or analog waveform
Clock Edge (Use Clock Edge = Yes)	Sets the signal transition edge (rising, falling, or either) for evaluating the logic condition at the clock transition.
Clock Threshold (Use Clock Edge = Yes)	Sets the threshold level that the clock signal must pass through to be considered a valid transition. The clock threshold value is independent of the input signal threshold(s).
Define Logic	Sets the logic condition that must occur with all inputs. <ul style="list-style-type: none"> ■ AND: All conditions are true. ■ OR: Any condition is true. ■ NAND: One or more conditions are true. ■ NOR: No conditions are true.
Mode & Holdoff	Trigger Mode determines how the instrument behaves in the absence or presence of a trigger event. Holdoff sets the amount of time the oscilloscope waits after a trigger event before detecting and triggering on the next trigger event. For additional information on Trigger Mode, Holdoff, forcing a trigger, and the Trigger Frequency Counter see Mode and Holdoff panel on page 271.
Act On Trigger	Set the actions the instrument takes when a trigger event occurs. For additional information on the Act On Trigger panel see Act On Trigger configuration menu on page 273.

Trigger types.

- *Edge Trigger menu*
- *Pulse Width Trigger menu*
- *Timeout Trigger menu*
- *Runt Trigger menu*
- *Logic Trigger menu*
- *Setup & Hold Trigger menu*
- *Rise/Fall Time Trigger menu*
- *Video Trigger menu*
- *Bus Trigger menu*
- *Sequence Trigger menu*

Logic Trigger - Define Inputs configuration menu

Use this menu to set the signal sources, logic states, and threshold levels to use for the Logic trigger.

To open the Logic Trigger - Define Inputs configuration menu:

1. Double-tap the **Trigger** badge on the Settings bar.
2. Set **Trigger Type** to **Logic**.
3. Tap the **Logic Pattern Define Inputs** button.

Logic Trigger - Define Inputs configuration menu fields and controls.

Field or control	Description
Chx (analog channels) or Dx (digital channels)	<p>Use to select the signal source's logic condition on which to perform the logic trigger (High, Low, Don't Care). Tap to select.</p> <p>If a channel is a digital channel, tap the + symbol to open the list of digital inputs (D0-D7) from which to select individual logic conditions for the digital signals.</p> <p>Use the Threshold field to set the signal level that must be exceeded for that signal to be true (logical 1).</p>
Set All	Sets all signal sources to detect a logic High , Low , or Don't Care condition.

Pulse Width Trigger configuration menu

Use the Pulse Width Trigger to trigger on specific pulse width conditions, including when a pulse width is within or outside a range of specified times. Pulse Width triggers are often used to troubleshoot digital signals.

To open the Pulse Width trigger configuration menu:

1. Double-tap the **Trigger** badge on the Settings bar.
2. Set the **Trigger Type** to **Pulse Width**.

Settings panel (Pulse Width Trigger configuration menu) fields and controls.

Field or control	Description
Source	Lists the source channel or waveform to use to trigger.
Trigger When	<ul style="list-style-type: none"> ■ < Limit: A pulse width is less than the specified time limit. ■ > Limit: A pulse width is greater than the specified time limit. ■ = Limit: A pulse width is equal to the specified time limit. ■ ≠ Limit: A pulse width does not equal (is greater than or less than) the specified time limit. ■ Inside Range: A pulse width is in the specified time range. ■ Outside Range: A pulse width is outside of the specified time range.
Level	Sets the amplitude level that the signal must pass through to be considered a valid transition.
Set to 50%	Sets the threshold at 50% of the measured signal transition range. 50% is calculated as (Top + Bottom)/2.
Time Limit (Trigger When ≠ Inside Range or Outside Range)	Sets the time period condition to be met.
High Time Limit (Trigger When = Inside Range or Outside Range)	Sets the longest acceptable pulse width time period for the range condition.
Low Time Limit (Trigger When = Inside Range or Outside Range)	Sets the shortest acceptable pulse width time period for the range condition.
Polarity	Sets the polarity of the pulse to detect (positive pulse only, negative pulse only).
Mode & Holdoff	Trigger Mode determines how the instrument behaves in the absence or presence of a trigger event. Holdoff sets the amount of time the oscilloscope waits after a trigger event before detecting and triggering on the next trigger event. For additional information on Trigger Mode, Holdoff, forcing a trigger, and the Trigger Frequency Counter see Mode and Holdoff panel on page 271.
Act On Trigger	Set the actions the instrument takes when a trigger event occurs. For additional information on the Act On Trigger panel see Act On Trigger configuration menu on page 273.

Trigger types.

- *Edge Trigger menu*
- *Pulse Width Trigger menu*
- *Timeout Trigger menu*
- *Runt Trigger menu*
- *Logic Trigger menu*
- *Setup & Hold Trigger menu*
- *Rise/Fall Time Trigger menu*
- *Video Trigger menu*
- *Bus Trigger menu*
- *Sequence Trigger menu*

Rise Fall Time Trigger configuration menu

Use the Rise/Fall Time trigger to trigger when the rise or fall time of a signal is less than, greater than, equal to, or not equal to a specified time limit.

To open the Rise/Fall Time trigger configuration menu:

1. Double-tap the **Trigger** badge on the Settings bar.
2. Set the **Trigger Type** to **Rise/Fall Time**.

Settings panel (Rise/Fall Time Trigger configuration menu) fields and controls.

Field or control	Description
Source	Lists the source channel or waveform to use to trigger.
Trigger When	<ul style="list-style-type: none"> ■ < Limit: A signal has a rise/fall time less than the specified time limit. ■ > Limit: A signal has a rise/fall time greater than the specified time limit. ■ = Limit: A signal has a rise/fall time that is equal to the specified time limit ($\pm 5\%$). ■ \neq Limit: A signal has a rise/fall time that does not equal (is greater than or less than) the specified time limit ($\pm 5\%$).
Time Limit	Sets the time period condition to be met.
Slope	Sets the signal transition direction to detect. (rising, falling, or either direction).
Upper Threshold	Sets the upper amplitude level through which the signal must pass to be considered a valid transition.
Lower Threshold	Sets the lower amplitude level through which the signal must pass to be considered a valid transition.
Mode & Holdoff	Trigger Mode determines how the instrument behaves in the absence or presence of a trigger event. Holdoff sets the amount of time the oscilloscope waits after a trigger event before detecting and triggering on the next trigger event. For additional information on Trigger Mode, Holdoff, forcing a trigger, and the Trigger Frequency Counter see Mode and Holdoff panel on page 271.
Act On Trigger	Set the actions the instrument takes when a trigger event occurs. For additional information on the Act On Trigger panel see Act On Trigger configuration menu on page 273.

Trigger types.

- [Edge Trigger menu](#)
- [Pulse Width Trigger menu](#)
- [Timeout Trigger menu](#)
- [Runt Trigger menu](#)
- [Logic Trigger menu](#)
- [Setup & Hold Trigger menu](#)
- [Rise/Fall Time Trigger menu](#)
- [Video Trigger menu](#)
- [Bus Trigger menu](#)
- [Sequence Trigger menu](#)

Runt Trigger configuration menu

Use the Runt trigger to trigger on waveforms where a low amplitude pulse crosses one threshold but fails to cross a second threshold before recrossing the first.

To open the Runt trigger configuration menu:

1. Double-tap the **Trigger** badge on the Settings bar.
2. Set the **Trigger Type** to **Runt**.

Settings panel (Runt Trigger configuration menu) fields and controls.

Field or control	Description
Source	Lists the source channel or waveform to use to trigger.
Trigger When	<ul style="list-style-type: none"> ■ Occurs: A runt signal event occurs. ■ < Limit: A runt signal event occurs that has a pulse width less than the specified time limit. ■ > Limit: A runt signal event occurs that has a pulse width greater than the specified time limit. ■ = Limit: A runt signal event occurs that has a pulse width that is equal to the specified time limit ($\pm 5\%$). ■ \neq Limit: A runt signal event occurs that has a pulse width that does not equal (is greater than or less than) the specified time limit ($\pm 5\%$).
Polarity	Sets the polarity of the pulse to detect (positive pulse only, negative pulse only, or a positive or negative pulse).
Time Limit	Sets the time period condition to be met.
Upper Threshold	Sets the upper amplitude level through which the signal must pass to be considered a valid transition.
Lower Threshold	Sets the lower amplitude level through which the signal must pass to be considered a valid transition.
Mode & Holdoff	Trigger Mode determines how the instrument behaves in the absence or presence of a trigger event. Holdoff sets the amount of time the oscilloscope waits after a trigger event before detecting and triggering on the next trigger event. For additional information on Trigger Mode, Holdoff, forcing a trigger, and the Trigger Frequency Counter see Mode and Holdoff panel on page 271.
Act On Trigger	Set the actions the instrument takes when a trigger event occurs. For additional information on the Act On Trigger panel see Act On Trigger configuration menu on page 273.

Trigger types.

- *Edge Trigger menu*
- *Pulse Width Trigger menu*
- *Timeout Trigger menu*
- *Runt Trigger menu*
- *Logic Trigger menu*
- *Setup & Hold Trigger menu*
- *Rise/Fall Time Trigger menu*
- *Video Trigger menu*
- *Bus Trigger menu*
- *Sequence Trigger menu*

Sequence Trigger configuration menu

Use Sequence trigger to trigger on a second (B) event after a first (A) event occurs. You can trigger on the first occurrence of event B (with or without a time delay), or trigger after a specified number of B events occur.

To open the Sequence trigger configuration menu:

1. Double-tap the **Trigger** badge on the Settings bar.
2. Set the **Trigger Type** to **Sequence**.

NOTE. *You can select sequence triggering when you choose the slope type Falling or Rising — but not when you pick the slope type Both.*

Settings panel (Sequence Trigger configuration menu) fields and controls.

Field or control	Description
Coupling	Sets the trigger coupling. Edge and Sequence triggering can use all available coupling types: DC, AC, Low Frequency Rejection, High Frequency Rejection, and Noise Rejection. All other trigger types use DC coupling only.
A Source	Selects the source of the first (A) event trigger. If the A event does not occur, no trigger event is generated.
B Source	Selects the source of the second (B) event trigger. If the A event occurs but the B event does not occur, no trigger event is generated.
A Level	Sets the A trigger level.
B Level	Sets the B trigger level.
Set to 50%	Sets the trigger level to 50% of the applied signal.
After the A Trigger Event is found: Trigger on the 1st B event	Sets the oscilloscope to trigger on the first occurrence of the B event trigger conditions.
After a Delay of:	Sets a time delay condition for the Trigger on 1st B event condition. The oscilloscope waits the specified time period after the A event before detecting and triggering on the B event condition. Available when After the A Trigger Event is found = Trigger on the 1st B event.
After the A Trigger Event is found: Trigger on the Nth B event	Sets the B trigger event to wait for a specified number of trigger events before generating a trigger.
Where N is:	Sets the number of B trigger events that must occur before triggering the oscilloscope. Available when After the A Trigger Event is found = Trigger on the Nth B event.
Mode & Holdoff	Trigger Mode determines how the instrument behaves in the absence or presence of a trigger event. Holdoff sets the amount of time the oscilloscope waits after a trigger event before detecting and triggering on the next trigger event. For additional information on Trigger Mode, Holdoff, forcing a trigger, and the Trigger Frequency Counter see Mode and Holdoff panel on page 271.
Act On Trigger	Set the actions the instrument takes when a trigger event occurs. For additional information on the Act On Trigger panel see Act On Trigger configuration menu on page 273.

Trigger types.

- *Edge Trigger menu*
- *Pulse Width Trigger menu*
- *Timeout Trigger menu*
- *Runt Trigger menu*
- *Logic Trigger menu*
- *Setup & Hold Trigger menu*
- *Rise/Fall Time Trigger menu*
- *Video Trigger menu*
- *Bus Trigger menu*
- *Sequence Trigger menu*

Setup & Hold Trigger configuration menu

Use the Setup & Hold trigger to trigger on a waveform when a data signal changes state inside of a specified setup and hold time, relative to a clock edge.

To open the Setup & Hold trigger configuration menu:

1. Double-tap the **Trigger** badge on the Settings bar.
2. Set the **Trigger Type** to **Setup & Hold**.

Settings panel (Setup & Hold Trigger configuration menu) fields and controls.

Field or control	Description
Clock Source	Sets the signal to use as the clock. The clock source can be an analog, digital, math, or reference waveform.
Clock Threshold	Sets the threshold level that the clock signal must pass through to be considered a valid transition. The clock threshold value is independent of the input signal threshold(s).
Clock Edge	Sets the polarity of the clock edge (rising or falling) for evaluating the other menu conditions.
Data Sources: Define Inputs	Opens the Setup & Hold Trigger - Define Inputs menu. Use this menu to select the input signals and their thresholds. See Setup & Hold Trigger - Define Inputs configuration menu on page 268.
Setup Time	Sets the length of time that data signal should be stable and not change before a clock edge occurs.
Hold Time	Sets the length of time that data signal should be stable and not change after a clock edge occurs.
Mode & Holdoff	Trigger Mode determines how the instrument behaves in the absence or presence of a trigger event. Holdoff sets the amount of time the oscilloscope waits after a trigger event before detecting and triggering on the next trigger event. For additional information on Trigger Mode, Holdoff, forcing a trigger, and the Trigger Frequency Counter see Mode and Holdoff panel on page 271.
Act On Trigger	Set the actions the instrument takes when a trigger event occurs. For additional information on the Act On Trigger panel see Act On Trigger configuration menu on page 273.

Trigger types.

- [Edge Trigger menu](#)
- [Pulse Width Trigger menu](#)
- [Timeout Trigger menu](#)
- [Runt Trigger menu](#)
- [Logic Trigger menu](#)
- [Setup & Hold Trigger menu](#)
- [Rise/Fall Time Trigger menu](#)
- [Video Trigger menu](#)
- [Bus Trigger menu](#)
- [Sequence Trigger menu](#)

Setup & Hold Trigger - Define Inputs configuration menu

Use this menu to set the input signals and their threshold levels for the Setup & Hold trigger.

To open the Setup & Hold Trigger - Define Inputs menu:

1. Double-tap the **Trigger** Badge.
2. Set the **Trigger Type** to **Setup & Hold**.
3. Tap the **Data Sources Define Inputs** button.

Setup & Hold Trigger - Define Inputs configuration menu fields and controls.

Field or control	Description
Chx (analog channels) or Dx (digital channels)	Use to select the signal sources to test for the setup and hold condition. Tap to select an input source. If a channel is a digital channel, tap the + symbol to open the list of digital inputs (D0-D7) or (D8-D15) from which to select individual digital signals. Use the Threshold field to set the signal level that must be exceeded for that signal to be true.
Set All	Sets all signal sources to be included or not included.

Timeout Trigger configuration menu

Use the Timeout Trigger to trigger on a waveform when an expected signal does not transition within a specified period of time, such as when a signal gets stuck either high or low.

To open the Timeout trigger menu:

1. Double-tap the **Trigger** badge on the Settings bar.
2. Set the **Trigger Type** to **Timeout**.

Settings panel (Timeout Trigger configuration menu) fields and controls.

Field or control	Description
Source	Lists the source channel or waveform to use to trigger.
Trigger When	<ul style="list-style-type: none"> ■ Stays High: The signal stays above the specified threshold level longer than the specified time. ■ Stays Low: The signal stays below the specified threshold level longer than the specified time. ■ Either: The signal stays above or below the specified threshold level longer than the specified time.
Threshold	Sets the amplitude level that the signal must pass through to be considered a valid transition.
Set to 50%	Sets the threshold at 50% of the measured signal transition range. 50% is calculated as $(\text{Top} + \text{Bottom})/2$.
Time Limit	Sets the time period condition to be met.
Mode & Holdoff	Trigger Mode determines how the instrument behaves in the absence or presence of a trigger event. Holdoff sets the amount of time the oscilloscope waits after a trigger event before detecting and triggering on the next trigger event. For additional information on Trigger Mode, Holdoff, forcing a trigger, and the Trigger Frequency Counter see Mode and Holdoff panel on page 271.
Act On Trigger	Set the actions the instrument takes when a trigger event occurs. For additional information on the Act On Trigger panel see Act On Trigger configuration menu on page 273.

Trigger types.

- [Edge Trigger menu](#)
- [Pulse Width Trigger menu](#)
- [Timeout Trigger menu](#)
- [Runt Trigger menu](#)
- [Logic Trigger menu](#)
- [Setup & Hold Trigger menu](#)
- [Rise/Fall Time Trigger menu](#)
- [Video Trigger menu](#)
- [Bus Trigger menu](#)
- [Sequence Trigger menu](#)

Video trigger configuration menu

Use the Video Trigger menu to trigger the oscilloscope on video signals.

Trigger on specified fields or lines of a composite video signal. Only composite signal formats are supported. Trigger on NTSC, PAL, or SECAM signals. Triggering also works with Macrovision signals.

Trigger on a variety of HDTV video standard signals, as well as custom (non-standard) bilevel and trilevel video signals with 3 to 4,000 lines.

To open the Video trigger menu:

1. Double-tap the **Trigger** badge on the Settings bar.
2. Set the **Trigger Type** to **Video**.

Settings panel (Video Trigger configuration menu) fields and controls.

Field or control	Description
Trigger Type	Set to Video .
Source	Lists the source channel or waveform to use to trigger.
Format	Set the video format from the drop-down list.
Trigger On	Set to trigger on lines or fields from the drop-down list.
Line Number	Set the line number to trigger on. This control is only available when Trigger On is set to Line Number.
Polarity	Sets the video polarity. (Normal or Inverted).
Scan Method	Set the scan method to Progressive or Interlaced.
Line Period	Set the line period when the format is set to Bilevel Custom or Trilevel Custom.
Sync Interval	Set the sync interval when the format is set to Bilevel Custom or Trilevel Custom.
Mode & Holdoff	Trigger Mode determines how the instrument behaves in the absence or presence of a trigger event. Holdoff sets the amount of time the oscilloscope waits after a trigger event before detecting and triggering on the next trigger event. For additional information on Trigger Mode, Holdoff, forcing a trigger, and the Trigger Frequency Counter see Mode and Holdoff panel on page 271.
Act On Trigger	Set the actions the instrument takes when a trigger event occurs. For additional information on the Act On Trigger panel see Act On Trigger configuration menu on page 273.

Trigger types.

- *Edge Trigger menu*
- *Pulse Width Trigger menu*
- *Timeout Trigger menu*
- *Runt Trigger menu*
- *Logic Trigger menu*
- *Setup & Hold Trigger menu*
- *Rise/Fall Time Trigger menu*
- *Video Trigger menu*
- *Bus Trigger menu*
- *Sequence Trigger menu*

Mode and Holdoff panel

Use the mode and holdoff panel controls to stabilize triggering.

To open the Pulse Width trigger configuration menu:

1. Double-tap the **Trigger** badge on the Settings bar.
2. Tap **Mode & Holdoff** to open the Mode & Holdoff panel.

Mode & Holdoff panel fields and controls.

Field or control	Description
Trigger Mode	<p>The trigger mode determines how the instrument behaves in the absence or presence of a trigger event:</p> <p>Auto trigger mode enables the instrument to acquire and display a waveform even if a trigger does not occur. Auto mode uses a timer that starts when the acquisition is started, and the pretrigger information is obtained. If a trigger event is not detected before the timer times out, the instrument forces a trigger. The length of time it waits for a trigger event depends on the time base setting.</p> <p>When forcing triggers in the absence of valid triggering events, Auto mode does not synchronize the waveform on the display. The waveform will appear to jump across the screen.</p> <p>If valid triggers occur, the display will become stable.</p> <p>Normal trigger mode enables the instrument to acquire a waveform only when it is triggered. If no trigger occurs, the last waveform record acquired remains on the display. If no last waveform exists, no waveform is displayed.</p>
Force Trigger	<p>Forces a trigger event regardless of whether the waveform meets any trigger conditions.</p>
Holdoff	<p>Trigger holdoff sets the amount of time the oscilloscope waits after a trigger event before detecting and triggering on the next trigger event. Use this option when the signal that you want to trigger on has several possible trigger points or is a burst signal. This control is only available when the trigger type is not video.</p>
Holdoff (Time)	<p>Use the multipurpose knob to adjust the holdoff time value. Or double-tap the field and use the virtual keypad to enter a time holdoff period. This control is only available when the trigger type is video.</p>
Holdoff (Fields)	<p>Use the multipurpose knob to adjust the holdoff fields value. Or double-tap the field and use the virtual keypad to enter a fields holdoff value. This control is only available when the trigger type is video.</p>
Trigger Frequency Counter	<p>Turn On to display the trigger event frequency in the Trigger badge.</p> <p>The trigger frequency can help you troubleshoot signal problems where the frequency of the trigger event may be related to a clock, switching power supply, or other recurrent frequency that occurs on your DUT.</p> <p>Only available if you have installed the DVM option, which is available when you register your instrument with Tektronix.</p>

Act On Trigger configuration menu

Use this configuration menu to set the actions the instrument takes when a trigger event occurs.

To open the Act On Trigger configuration menu:

1. Double-tap the **Trigger** badge on the Settings bar.
2. Tap **Act On Trigger** to open the Act On Trigger panel.

Act On Trigger menu fields and controls. Displayed fields and controls can change depending on menu selections.

Field or control	Description
Act on Trigger on/off switch	Allows you to configure AOE before enabling. If the maximum number of saves is hit, this control turns off.
Save Image	Saves the screen image at the time of the event, to the format designated in the Save Configuration panel.
Save Waveform	Saves the waveform data at the time of the event, to the format designated in the Save Configuration panel.
Stop Acquisitions	Stops the instrument from acquiring any more data.
SRQ	Generates a service request (SRQ) when a specified event occurs.
AUX OUT Pulse	Sends a pulse to the Auxiliary Out port when a specified event occurs.

Actions guidelines.

- All actions are taken on a per acquisition basis.

Viewing the trigger frequency

You can display a readout of trigger frequency.

The Trigger Frequency Counter counts all Edge trigger triggerable events, whether the instrument triggered on them or not, and displays the number of times per second that they occur. To display this readout, do the following:

1. Double-tap the **Trigger** badge to display the trigger menu.
2. Tap **Mode & Holdoff** to display the Mode & Holdoff panel.
3. Tap **Trigger Frequency Counter** to toggle it on.
4. Tap an empty location on the display to close the Trigger menu.

The trigger frequency now appears in the Trigger badge.

Virtual Keyboard

Use the onscreen virtual keyboard to enter textual information such as a file path, file name, or label text.

To access the virtual keyboard, double-tap in a menu or dialog text input box. Enter your text and tap **Enter** to close the keyboard and add your text to the menu or dialog field.

Tap **ESC**, **Cancel**, or anywhere outside the keyboard, to dismiss it without adding text to the input box.

Single-tap in the keyboard text field to position the insertion cursor at that location. Double-tap to select individual words. Triple-tap to select all text in the field.

Touch and drag the title bar to move the keyboard on the screen.

Binary, decimal, hex, and octal virtual keypads

Use the logic keypad to edit bus logic values for trigger settings. Using a logic keypad is faster to set larger logic trigger values than using the multipurpose knobs in the trigger menu.

To open the logic keypad, double-tap inside a field that requires logic values. Which field you select (Binary, Hex, and so on) sets which logic keypad is displayed.

Logic Keypad fields and controls

Field or control	Description
Clear	Sets all digits to X (don't care) for binary, hex, and octal formats. Decimal gets set to 0.
<	Moves the insertion point left and highlights the character that can be edited.
>	Moves the insertion point right and highlights the character that can be edited.
Keypad	Provides a keypad associated with the logic entry field that was double-tapped in the Trigger menu. Tapping a key sets the selected digit to the specified value and moves the selected digit indicator to the next (right) digit. You can also use an attached keyboard to enter values in the keypad character field.

Numeric input keypad

Use the virtual Keypad to enter numeric values and units for settings.

To open the virtual keypad, double-tap inside a field that requires numeric values.

Virtual Keypad fields and controls

Field or control	Description
Clear	Clears all values from the input entry field.
Exp	Lets you enter exponential notation entries.
Max	Enters the maximum value allowed for this setting.
Min	Enters the minimum value allowed for this setting.
Bksp ←	Deletes characters to the left of the insertion point.
Enter	Closes the number pad and assigns the entered value to the field.
±	Sets a numeric value to a positive (default) or negative value.
Unit buttons	Use to set the units of the entered value.

IP address keypad

Use the virtual Logic keypad to edit bus logic values for trigger settings. Using a logic keypad is faster to set larger logic trigger values than using the multipurpose knobs in the trigger menu.

To open the IP address keypad, double-tap inside IP address field.

IP address Keypad fields and controls

Field or control	Description
Clear	Clears all values from the input entry field.
<	Moves the insertion point left and highlights the character that can be edited.
>	Moves the insertion point right and highlights the character that can be edited.
Enter	Closes the keypad and assigns the entered value to the field.
Cancel	Closes the keypad without saving entered values.

Waveform View configuration menu

Use this menu to configure the Waveform View to set style, persistence, intensity, markers, spectrogram, and other parameters.

To open the Waveform View menu, double-tap anywhere in the Waveform View screen.

Time Domain Waveform View menu fields and controls

Fields or controls	Description
Persistence	<p>Sets the length of time data points are displayed on screen before being erased.</p> <p>Off sets the record points to appear for the current acquisition only.</p> <p>Infinite continuously accumulates record points on the waveform until you change one of the acquisition display settings or clear the acquisition memory. Use infinite persistence for displaying record points that may occur outside the normal acquisition envelope.</p> <p>Variable lets you specify a time length to retain data points on screen. Each record point decays independently according to the time interval.</p> <p>Auto sets the Waveform Intensity field to control the persistence time.</p>
Variable Persistence Time (Persistence = Variable)	Sets the length of time data points remain displayed. Tap the field and use the A knob to adjust, or double-tap and use the keypad to set a time.
Waveform Style	<p>Sets how waveforms are drawn on the screen.</p> <p>Vectors draws waveforms with lines between record points.</p> <p>Dots draws waveform record points as dots on the screen, and adds crosshair markers to real sampled points.</p>
Graticule Style	<p>Sets the type of graticule to display.</p> <p>Full displays a frame, cross hairs, and a grid on the display. This style is useful for making quick, full-screen measurements with cursors and automatic readouts when cross hairs are not needed.</p> <p>Grid, Solid, and Cross Hair provide compromises between Frame and Full.</p> <p>Frame provides a clean screen on which you can most easily read automatic measurement results and other screen text.</p>
Waveform Intensity	Sets the brightness of waveforms. Tap the field and use the A knob to set the intensity.
Graticule Intensity	Sets the brightness of the graticule. Tap the field and use the A knob to set the graticule intensity.
Screen Annotation	Use the keyboard to add text to the display.

**Frequency Domain (RF)
Waveform View menu
fields and controls**

Fields or controls	Description
Peak Markers	Enables (On) or disables (Off) showing triangular marks on spectrum waveform peaks. Default is On. The highest peak on the currently selected trace is the reference marker. Peak marker symbols (triangle at top of view) are colored red for the reference marker and white otherwise
Readout	Sets the marker readouts to show Absolute or Delta values. The default value is Absolute. Delta readouts are relative to the Reference Marker.
Quantity	Sets the maximum number of highest peak markers to show on traces in the Waveform View window. The default value is 5. If there are fewer peaks in the Waveform View window than this control is set for, only the displayed peaks will be marked.
Threshold	Sets the minimum amplitude that a signal must exceed to be a valid peak.
Excursion	Sets how far a signal needs to fall in amplitude between marked peaks to be another valid peak.
Reference To Center	Moves the reference marker to the center of the display.
Spectrogram	Toggles the spectrogram traces on or off. The spectrogram display is useful for monitoring slowly-changing RF phenomena. The x-axis represents frequency, just like the typical spectrum display. The y-axis represents time. Color indicates amplitude. Spectrogram slices are generated by taking each spectrum and flipping it on its edge so that it is one pixel row tall, and then assigning colors to each pixel based on the amplitude at that frequency with the cold colors of blue and green representing low amplitude, and the hotter colors of yellow and red indicating higher amplitude. Each new acquisition adds another slice at the bottom of the spectrogram, and the history moves up one row. See Spectrogram display on page 295 for more information.
Graticule Style	Sets the type of graticule to display. Full displays a frame, cross hairs, and a grid on the display. This style is useful for making quick, full-screen measurements with cursors and automatic readouts when cross hairs are not needed. Grid, Solid, and Cross Hair provide compromises between Frame and Full. Frame provides a clean screen on which you can most easily read automatic measurement results and other screen text.
Graticule Intensity	Sets the brightness of the graticule. Tap the field and use the A knob to set the graticule intensity.
Screen Annotation	Double-tap the field and use the keyboard to add text to the display.
Selected Trace	Makes the Normal, Average, Max Hold, or Min Hold trace the selected trace.

Cursors menu (RF view)

Use the RF view cursors to take manual measurements on spectrum signals.

To open the RF view cursors menu, double-tap on a cursor or its readout in the **Waveform View** window.

Cursors menu (RF view), fields and controls

Field or control	Description
Display	Toggles the spectrum cursor display On or Off .
Reference To Center	Moves the reference cursor to the center of the display.
Cursor A X-Position	Sets a specific x-axis position for Cursor A using the multipurpose knob or the virtual keypad.
Cursor B X-Position	Sets a specific x-axis position for Cursor B using the multipurpose knob or the virtual keypad.
Readout	Sets the cursor readouts to show Absolute or Delta values. Delta readouts are relative to the Reference Marker.

RF badge menu

Use the RF badge menu to set spectrum parameters including reference level, amplifier mode, spectrum traces, detection method, and spectrogram.

To open the RF badge menu, double-tap the badge.

RF badge menu, fields and controls

Field or control	Description
Display	Enables (On) or disables (Off) showing RF traces.
Reference Level	Sets the reference level using the multipurpose knob, double-tap to bring up the virtual keypad, or tap the up and down arrows to change the level.
Scale	Sets the vertical scale using the multipurpose knob, double-tap to bring up the virtual keypad, or tap the up and down arrows to change the scale.
Position	Set the vertical position using the virtual keypad.
Label	Enter a label using the keyboard.
Units	Sets the measurement unit to use in the vertical scale in the RF waveform view.
Amplifier Mode	When a TPA-N-PRE (preamplifier) is attached to the RF input, tap to toggle between Auto and Bypass mode. The readout indicates preamplifier mode.

Field or control	Description
Spectrum Traces	<p>Add or remove Normal, Average, Max Hold, or Min Hold traces to the display.</p> <ul style="list-style-type: none"> ■ Normal sets the spectrum trace to show the first sample point data in each sample interval. ■ Average sets the spectrum trace to show the average of the normal points in each sample interval over several acquisitions. ■ Max Hold sets the spectrum trace to show the highest amplitude points in each sample interval over several acquisitions. ■ Min Hold sets the spectrum trace to show the lowest amplitude points in each sample interval over several acquisitions. <p>Sets the trace mode to show all available sample point data in the spectrum trace.</p>
Detection Type	<p>Displays the detection type, or, if the detection method is set to Manual, allows you to select the detection type: +Peak, Average, Sample, or -Peak.</p>
Detection Method	<p>Select the detection method:</p> <ul style="list-style-type: none"> ■ Auto allows the instrument to select the detection type. ■ Manual allows you to select the detection type: +Peak, Average, Sample, or -Peak.
Number of Averages	<p>When the Average spectrum trace is selected, sets the spectrum trace to show the average of the normal points in each sample interval over several acquisitions.</p>
Spectrogram	<p>Toggles the spectrogram traces on or off. The spectrogram display is useful for monitoring slowly-changing RF phenomena. The x-axis represents frequency, just like the typical spectrum display. The y-axis represents time. Color indicates amplitude.</p> <p>Spectrogram slices are generated by taking each spectrum and flipping it on its edge so that it is one pixel row tall, and then assigning colors to each pixel based on the amplitude at that frequency with the cold colors of blue and green representing low amplitude, and the hotter colors of yellow and red indicating higher amplitude. Each new acquisition adds another slice at the bottom of the spectrogram, and the history moves up one row.</p>

Waveform acquisition concepts

Acquisition concepts

The Acquisition system sets which data points are used to acquire waveforms.

Acquisition hardware

Before a signal is displayed, it must pass through the input channel where it is scaled and digitized. Each channel has a dedicated input amplifier and digitizer. Each channel produces a stream of digital data from which the instrument extracts waveform records.

Sampling process

Acquisition is the process of sampling an analog signal, converting it into digital data, and assembling it into a waveform record, which is then stored in acquisition memory.

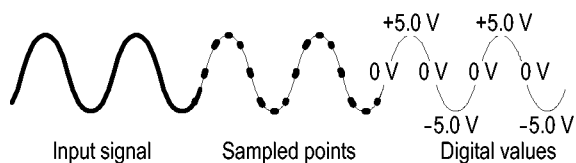

Waveform record

The instrument builds the waveform record through use of the following parameters:

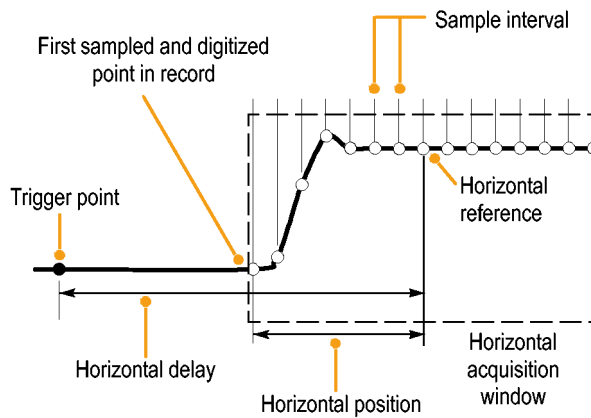

- Sample interval: The time between sample points.
- Record length: The number of samples required to fill a waveform record.
- Trigger point: The zero time reference in a waveform record.
- Horizontal position: When horizontal delay is off, the horizontal position is a percentage of the waveform record between 0 and 99.9 percent. The trigger point and the horizontal reference are at the same time in the waveform record. For example, if the horizontal position is 50 percent, then the trigger point is in the middle of the waveform record. When horizontal delay is on, the time from the trigger point to the horizontal reference is the horizontal delay.



Acquisition modes

Acquisition is the process of sampling an analog signal, converting it into digital data, and assembling it into a waveform record, which is then stored in acquisition memory. The acquisition mode determines how the waveform record points are calculated from the sampled waveform data.

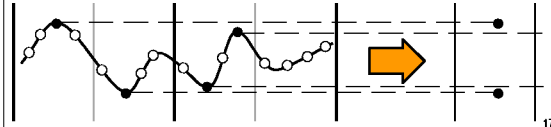
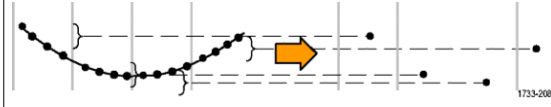
How the acquisition modes work

Acquisition mode	
<p>Sample mode retains the first sampled point from each acquisition interval. Sample is the default mode. The instrument does no post processing of the acquired samples in this mode.</p>	 <p>1733-210</p>
<p>Peak Detect mode retains the highest and lowest values of all the samples in two consecutive acquisition intervals. This mode only works with real-time, noninterpolated sampling and is useful for catching high frequency glitches.</p>	 <p>1733-207</p>
<p>High Res mode calculates the average of all the samples for each acquisition interval. This mode also only works with real-time, noninterpolated sampling. Hi-Res provides a higher-resolution, lower-bandwidth waveform.</p>	 <p>1733-208</p>
<p>Envelope mode finds the highest and lowest record points over many acquisitions. Envelope uses Peak Detect for each individual acquisition.</p>	 <p>1733-209</p>

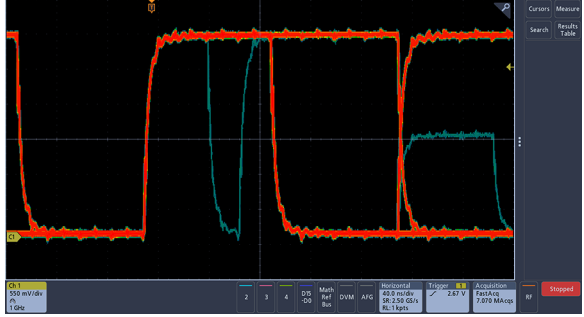
Acquisition mode	
<p>Average mode calculates the average value for each record point over a user-specified number of acquisitions. Average uses Sample mode for each individual acquisition. Use Average mode to reduce random noise.</p>	
<p>FastAcq™ mode is helpful in finding elusive signal anomalies. Fast acquisition mode reduces the dead time between waveform acquisitions, enabling the capture and display of transient events such as glitches and runt pulses. Fast acquisition mode can also display waveform phenomena at an intensity that reflects their rate of occurrence.</p>	

Roll Mode provides an instant display response when the oscilloscope is operating at very slow sweep speeds. Without it, the acquisition must complete before the display will update.

Roll Mode is not available in the Acquisition Mode drop-down menu. It is automatically enabled at Horizontal Scale factors of 40 ms/div and slower when running in Auto Trigger mode or in Single / Seq acquisition mode. The record length is limited to 1 M points when rolling.

Roll Mode is disabled when running in Normal Trigger mode. This can be selected with the front panel Trigger Mode button or the Trigger Mode control on the MODE & HOLDOFF panel of the Trigger configuration menu.

NOTE. *If Roll Mode is enabled, Average and Envelope will not be available in the Acquisition Mode drop-down list.*

Coupling

Coupling determines whether an input signal is directly connected to the input channel (DC coupling) or connected through a DC blocking capacitor (AC coupling).

All instruments and probes specify a maximum signal level. Do not exceed the limit, even momentarily, as the input channel or probe may be damaged. Use external attenuators if necessary to prevent exceeding the limits.

The input resistance of each input channel can be 1 M Ω or 50 Ω . To properly terminate signals when using coaxial cables, or to support active probes with different termination requirements, select the termination in the Channel menu Vertical Settings panel.

All probes expect a specific coupling and input termination. Both coupling and input termination are displayed on the screen. If the instrument determines the coupling and termination required by the probe, either implicitly because of the TekProbe/TekVPI interface or through performing a probe compensation, the instrument sets the required coupling and input termination.

Consider the following when you use 50 Ω termination with any channel:

- The instrument does not accurately display frequencies under 200 kHz if AC coupling is selected.
- The instrument reduces the maximum volts per division setting for the channel, since input amplitudes appropriate for the higher settings would overload the 50 Ω input.

Scaling and positioning

Set vertical scaling, positioning, and DC offsets to display the features of interest on your waveform and to avoid clipping.

The display contains ten major divisions. This represents the maximum digitizing range of the instrument for any given vertical scale. Vertical waveform data that is outside (above and/or below) the maximum range is clipped; that is, the data values exceed the digitizing capability of the ADC at the current settings.

Set the horizontal scale, position, and resolution (record length) to include the acquired waveform record waveform attributes of interest with good sampling density on the waveform. These settings define the horizontal acquisition window, described in .

NOTE. *The terms vertical acquisition window and horizontal acquisition window refer to the vertical and horizontal range of the segment of the input signal that the acquisition system acquires.*

Vertical acquisition considerations

You can set the vertical scale, position, and offset of each channel independently of other channels.

The offset control subtracts a constant DC level from the input signal before the vertical scale factor is applied, and the vertical position control adds a constant number of divisions of signal after the scale factor is applied to the resulting difference.

The vertical scale and position controls have the following effects on the waveform display and the displayed waveform:

The vertical volts per division you set determines the vertical size of the waveform display, allowing you to scale it to contain all of a waveform amplitude or only part.

NOTE. *Amplitude-related automatic measurements (for example, peak-to-peak and RMS) will be accurate for vertical windows if the waveform is not clipped. But if signal amplitude were to extend outside the vertical acquisition window, the data acquired is clipped. Clipped data causes inaccurate results if used in amplitude-related automatic measurements. Clipping also causes inaccurate amplitude values in waveforms that are stored or exported for use in other programs.*

If the scale of a math waveform is changed so that the math waveform is clipped, it will affect the amplitude measurements on that math waveform as follows:

- The vertical position adjusts the waveform relative to the graticule. Adjust the vertical position to place the waveforms where you want to see them. The waveform baseline indicators indicate the zero Volts (or Amps) level for each waveform. If you adjust the channel's Vertical Scale, the waveform expands or contracts around the waveform's baseline indicator.
- When you use the Channel Offset control to move a waveform, the baseline indicator no longer represents zero. Instead, it represents the level of the offset. Offset moves the waveform display to control the portion of the waveform amplitude the display captures. If you adjust the channel's Vertical Scale, the waveform expands or contracts around the waveform's baseline indicator.

Horizontal acquisition considerations

The instrument lets you define the horizontal waveform display parameters.

These common parameters specify a horizontal scale and position that is applied to all channels simultaneously.

These parameters are shown in the next figure (horizontal window with delay on):

- The trigger position determines where the trigger event will be located in the waveform record. To see more pretrigger data move your trigger position to the right on the graticule.
- The horizontal position determines the number of pretrigger and posttrigger samples. Samples before the trigger point are pretrigger samples and those after the trigger point are posttrigger samples. When Delay is off, the horizontal position is the same as the trigger position.
- The horizontal delay determines the time from the trigger point to the Horizontal Reference.
- The horizontal scale determines the horizontal size of the relative to any waveform, allowing you to scale it to contain a waveform edge, a cycle, or several cycles.

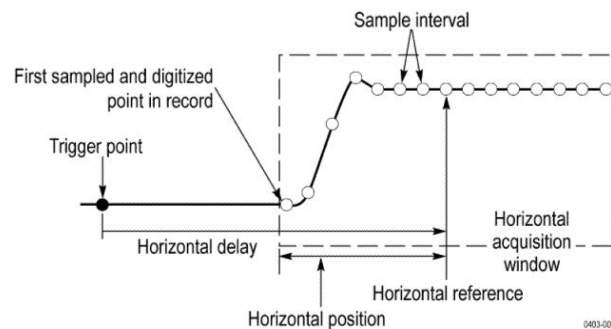

Using reference waveforms and traces

You can compare a reference waveform or trace to another waveform.

You can create and store a reference waveform or trace. For example, you might do this to set up a standard against which to compare other waveforms. To recall a previously saved reference waveform or trace:

1. Tap the **Add Math Ref Bus** button and then tap **Ref 1** . This creates a reference badge and displays the reference waveform.
2. Double-tap the **Ref 1** badge to open the Reference configuration menu.
3. Tap the **Vertical Scale** and **Vertical Position** fields and use the multipurpose knobs to adjust the vertical settings.
4. Tap the **Horizontal Scale** and **Horizontal Position** fields and use the multipurpose knobs to adjust the horizontal settings.
5. Double-tap **Label** and use the keyboard to define labels to display with the reference waveform and trace.
6. **Ref Details** provides information about the selected reference. Use this to determine whether the reference is an analog waveform or an RF trace.
7. To create a reference see [Save a waveform to a file](#) on page 111.

Quick Tips

- **Selecting and Displaying Reference Waveforms.** You can display all the reference waveforms at the same time.
- **Removing Reference Waveforms from the Display.** To remove a reference waveform from the display, tap the reference badge and flick it off the display.
- **Scaling and Positioning a Reference Waveform.** You can position and scale a reference waveform independently from all other displayed waveforms. You can do this whether acquisition is running or not.

If a reference waveform is selected, scaling and repositioning of the reference waveform operates the same way whether zoom is turned on or off.
- **Saving 10 M Reference Waveforms.** 10 M reference waveforms are volatile and not saved when the oscilloscope power is turned off. To keep these waveforms, save them to external storage.

Frequency-Domain concepts

Typical oscilloscope displays show electrical signals as a graph of amplitude on the y-axis versus time on the x-axis. The frequency domain RF view shows the same electrical signals as a graph of amplitude (or magnitude) on the y-axis versus frequency on the x-axis.

The same signal is simply displayed in two different ways. A time-domain signal is a composite of a number of discrete sine waves, each with their own frequency, magnitude, and phase. The frequency-domain spectrum is an decomposition of the signal into its constituent frequency components.

Displaying the Frequency Domain menu

Use the Frequency Domain menu to make vertical settings, display traces, and display a spectrogram.

1. Tap the **RF** button on the display or push the RF button on the front panel.
2. Double tap the **RF** badge to bring up the RF menu
3. Double-tap **Label** to display a keyboard and label the RF traces.
4. Double-tap **Reference Level**, **Scale**, or **Position** to display a keypad and configure the RF input.
5. Tap **Traces** to open the Traces panel.
6. Tap **Spectrogram** to toggle the spectrogram trace on.
7. Select the detection method:
 - **Auto** allows the instrument to select the detection type.
 - **Manual** allows you to select the detection type: +Peak, Average, Sample, or -Peak.

RF waveform view and badges

RF waveform view makes changes to system badges as follows:

When the RF mode is enabled, the **Waveform View** window is opened and a new RF badge is added to the Readout bar. The RF badge first line indicates the reference level of the RF waveform. The second line indicates the vertical scale of the RF waveform.

Spectrum trace handle

The spectrum trace handle provides details on the trace reference level, the source channel for the trace, and which trace types are displayed.

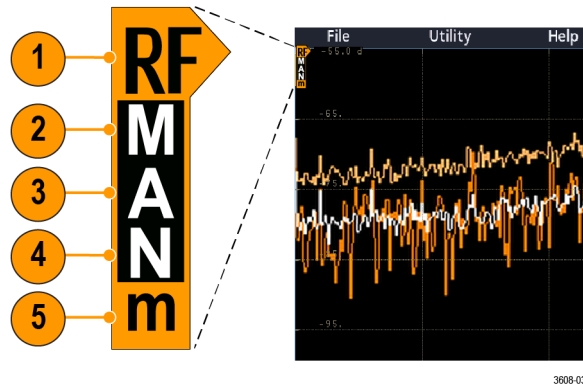

Figure 5: Spectrum trace MANm handle info

1. The RF trace indicator is placed at the Reference Level. The waveform view shows the spectrum traces relative to a Reference Level reference point. If the Reference level is above the top of the graticule, the handle is drawn at the top of the graticule and pointing up.
2. A capital M indicates that the maximum trace is enabled.
3. A capital A indicates that the average trace is enabled.
4. A capital N indicates that the normal trace is enabled.
5. The small m indicates that the minimum trace is enabled.

Highlighting around a letter indicates that trace type is selected. In the figure, the small m is highlighted, indicating that the minimum trace is currently selected.

There is an important distinction between enabled and selected traces:

- An enabled trace letter (displayed in the trace handle) means that trace type is being displayed.
- A selected trace (highlighted around the letter) is the trace that is used for measurements, marker readouts, and cursor readouts.

Spectrum trace markers

Automatic peak markers assist with quickly identifying the frequency and amplitude of peaks in the spectrum trace.

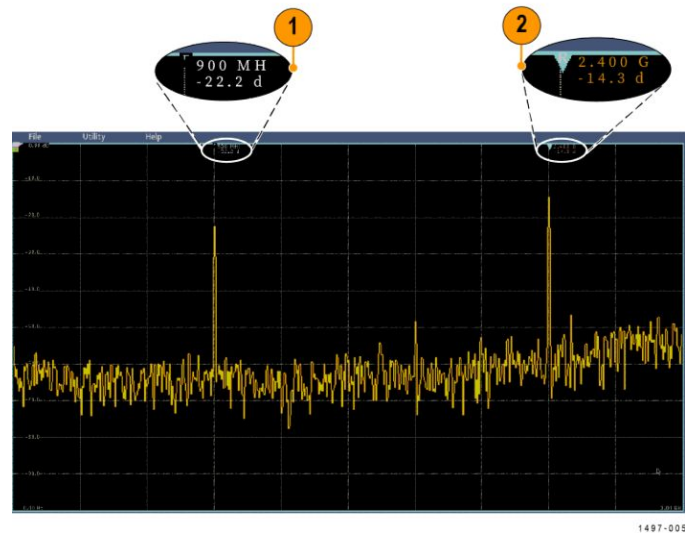
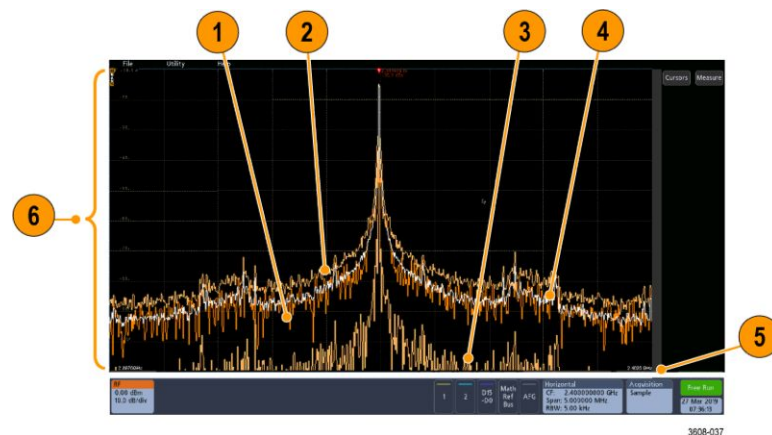

Figure 6: Spectrum trace markers

1. The Reference Marker is placed on the highest amplitude peak. It is marked with a Red triangle.
2. The Automatic markers mark the next highest peaks in the trace.
 - The automatic markers indicate frequency and amplitude.
 - Absolute readouts show the actual frequency and amplitude of the automatic markers.
 - Delta readouts show the frequency and amplitude of the automatic markers relative to the reference marker.

The RF waveform view user interface

This topic identifies objects in the RF waveform view.



1. Normal trace: Each acquisition is discarded as new data is acquired.
2. Max hold trace: The maximum data values are accumulated and displayed over multiple acquisitions of the Normal trace.

3. Min hold trace: The minimum data values are accumulated over multiple acquisitions of the Normal trace.
4. Average trace: Data from the Normal trace is averaged over multiple acquisitions. This is true power averaging, which occurs before the log conversion. Each power of 2 averaging reduces the displayed noise by 3 dB.
5. Amplitude (magnitude) scale.
6. Frequency span and scale. Shows the start and stop frequencies in the spectrum trace. The Horizontal badge shows the center frequency.

RF View guidelines

- The vertical and horizontal in-graticule labels apply to the currently selected channel.
- The MANm spectrum trace handle (see [Spectrum trace handle](#) on page 290) for the currently selected channel is shown highlighted, just like with analog channels.
- The MANm trace handle for non-selected traces are shown in the same fashion as non-selected analog channels.
- The **RF View** does not support zoom.
- Horizontal pinch and expand touch gestures adjust the spectrum span in the same style as a horizontal pinch/expand in the **Waveform View**.
- A horizontal pan adjusts the center frequency.
- Vertical pinch and expand touch gestures adjust the spectrum vertical scale in the same style as a vertical pinch/expand in the **Waveform View**.
- A vertical pan adjusts the vertical position.

Using spectral analysis controls

Use these control to configure the acquisition and display of the RF input.

1. Tap the **RF** badge or push the **RF** button to bring up the frequency domain display and create an RF badge. The RF menu provides access to the Spectrogram display.
2. Double-tap the **Horizontal** badge to open the Horizontal menu.
3. Specify the portion of the spectrum to view on the display:
 - Tap and use the multipurpose knob or double-tap the Center Frequency and Span fields or
 - Tap and use the multipurpose knob or double-tap the Start Frequency and Stop Frequency
4. Tap **RBW Mode** to define the resolution bandwidth
 - **Auto**, tap **Span:RBW** and use the keypad to set resolution bandwidth
 - **Manual**, tap **RBW** and use the multipurpose knob or double-tap **RBW** to set the resolution bandwidth.
5. Tap **Window** and select which FFT window to use. The choices are:
 - **Rectangular** see [Rectangular window](#) on page 334
 - **Hanning** see [Hanning FFT window](#) on page 333

- **Hamming** see *Hamming window* on page 334
 - **Blackman-Harris** see *Blackman-Harris FFT window concepts* on page 333
6. Double-tap the **RF** badge and use the controls to set the Reference Level and the Scale of the frequency domain traces.

Setting up the RF input

This topic helps set up the center frequency, span, and reference level.

Frequency and span parameters.

1. The center frequency is a precise frequency at the center of the display. In many applications, it is a carrier frequency.

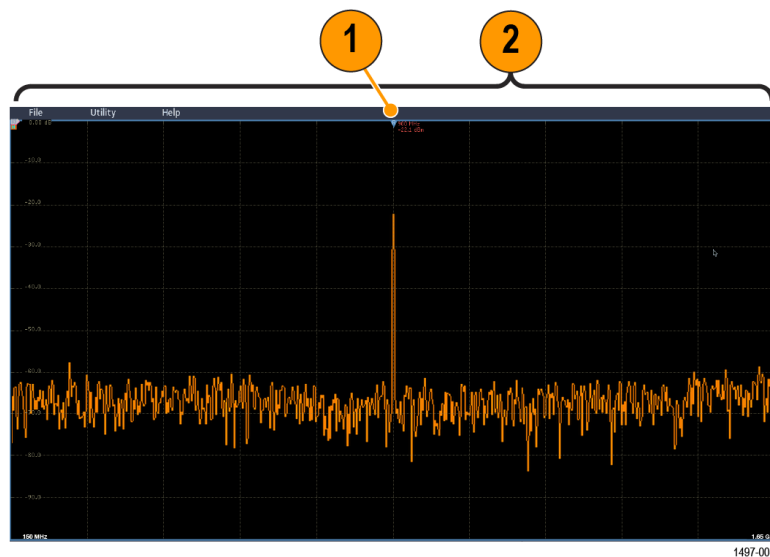

2. The span is the range of frequencies you can observe around the center frequency.

To define the center frequency and the span:

1. Tap the **RF** button on the display or push the RF button on the front panel.
2. Double-tap the **Horizontal** badge to display the Horizontal menu.
3. Double-tap **Center Frequency** and use the keypad to enter the desired center frequency.
4. Double-tap **Span** and use the keypad to enter the desired span.
5. Double-tap **Start Frequency** and use the keypad to set the lowest frequency to capture.
6. Double-tap **Stop Frequency** and use the keypad to set the highest frequency to capture.

Reference Level.

1. Double-tap the **RF** badge to open the RF menu.
2. Double-tap **Reference Level** and use the keypad to set the approximate maximum power level, as shown by the baseline indicator at the top of the frequency graticule.
3. Double-tap **Position** and use the keypad to set the position or tap **Position** and turn Multipurpose a to adjust the vertical position. You will move the baseline indicator up or down. This is useful if you want to move signals onto the visible display.
4. Tap **Scale** and turn Multipurpose a to adjust the vertical scale.
5. Tap **Units** and select the units of measure for the frequency domain. Choices are: dBm, dB μ W, dBmV, dB μ V, dBmA, and dB μ A.

This is useful if your application requires a different unit of measurement than that being currently displayed.

6. Tap **Auto Level** to direct the oscilloscope to automatically calculate and set the reference level for you.

Resolution bandwidth

Use resolution bandwidth to determine which frequencies the instrument can resolve.

The resolution bandwidth (RBW) determines the level to which the oscilloscope can resolve individual frequencies in the frequency domain. For example, if the test signal contains two carriers separated by 1 kHz, you will not be able to discriminate between them unless the RBW is less than 1 kHz.

The views below both show the same signal. The difference between them is their RBW.

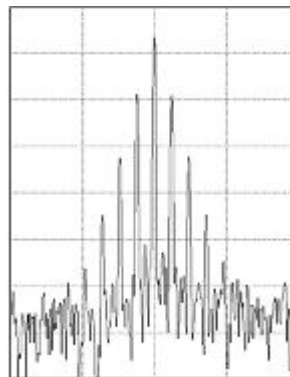

Figure 7: Lower (narrower) RBWs take longer to process, but have finer frequency resolution and a lower noise floor.

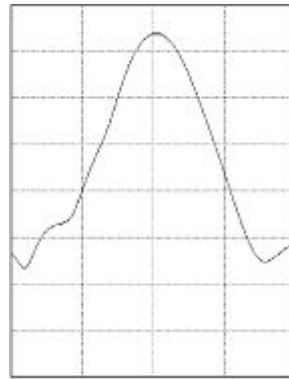

Figure 8: Higher (wider) RBWs take less time to process, but have less frequency resolution and a higher noise floor.

Do the following to adjust the resolution bandwidth.

1. In frequency domain mode, double-tap the **Horizontal** badge to display the Horizontal menu.
2. Tap **RBW Mode** to select either **Auto** or **Manual**.
 - **Auto** sets the resolution bandwidth automatically as you change the span. The default behavior is $RBW = \text{Span}/1000$.
 - **Manual** allows you to set your own resolution bandwidth.
3. To manually adjust the RBW, tap **RBW** and turn the multipurpose knob.
4. Tap **Span : RBW** and use the multipurpose knob to set the span/RBW ratio. This ratio is used when the RBW Mode is set to Auto. The default is 1000:1 but you can set it to other values.
5. Tap **Window** and select which FFT window to use. The choices are:
 - **Rectangular** see [Rectangular window](#) on page 334
 - **Hanning** see [Hanning FFT window](#) on page 333
 - **Hamming** see [Hamming window](#) on page 334
 - **Blackman-Harris** see [Blackman-Harris FFT window concepts](#) on page 333

Spectrogram display

The spectrogram display is useful for monitoring slowly-changing RF phenomena.

The spectrogram x-axis represents frequency, just like the typical spectrum display. The y-axis represents time. Color indicates amplitude.

Spectrogram slices are generated by taking each spectrum and flipping it on its edge so that it is one pixel row tall, and then assigning colors to each pixel based on the amplitude at that frequency with the cold colors of blue and green representing low amplitude, and the hotter colors of yellow and red indicating higher amplitude. Each new acquisition adds another slice at the bottom of the spectrogram, and the history moves up one row.

When acquisitions are stopped, you can navigate through the history of the spectrogram by pressing the side menu slice control and turning the Multipurpose a knob. When acquisitions are stopped and the spectrogram is displayed, the spectrogram slice trace is displayed as the Normal spectrum trace.

To use the spectrogram feature, display a trace in RF mode.

1. Double-tap the **RF** badge to display the RF menu.
2. Tap **Traces** to display the traces panel.
3. Tap Spectrogram to toggle the spectrogram display on.
4. To review each spectrum captured in the spectrogram, push **Run / Stop** to stop acquiring RF acquisitions. Turn Multipurpose knob a.

Automatic peak markers

This topic explains the automatic peak markers in the RF mode display.

Automatic peak markers are on by default and assist with quickly identifying the frequency and amplitude of peaks in the spectrum.

1. The Reference Marker is placed on the highest amplitude peak. It is marked with a red R in a triangle.
2. The automatic markers indicate frequency and amplitude.
3. Absolute readouts show the actual frequency and amplitude of the automatic markers.
4. Delta readouts show the frequency and amplitude of the automatic markers relative to the reference marker.

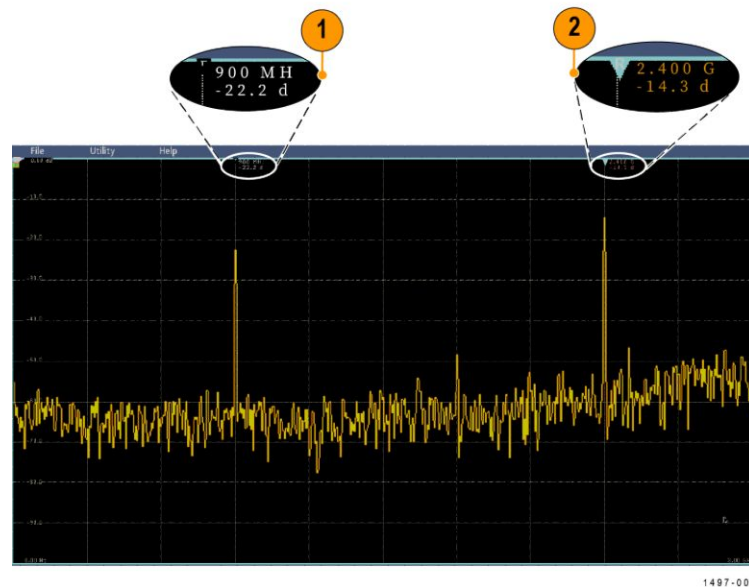

Each automatic marker has a readout associated with it. These can be absolute or delta readouts. An absolute marker readout shows the actual frequency and amplitude of the associated marker. A delta marker readout shows the frequency and amplitude differences from the Reference Marker. The Reference Marker's readout indicates absolute frequency and amplitude, regardless of the readout type.

NOTE. *Automatic markers can be turned on and off in the Waveform View menu. Tap **Peak Markers** to toggle the automatic markers on and off.*

Frequency domain cursors

This topic provides help in using frequency domain cursors.

Two cursors are provided to measure non-peak areas of the spectrum and to measure Noise Density and Phase Noise. When the cursors are turned on, the Reference Marker is no longer automatically attached to the highest amplitude peak. It is now assigned to the Multipurpose knob a and can be moved to any location. This enables easy measurement of any part of the spectrum as well as delta measurements to any part of the spectrum. This also allows measurement of non-peak spectral content. The readouts for cursors indicate frequency and amplitude, just like automatic marker readouts.

As with automatic peak marker readouts, the cursor readouts can show either absolute or delta values.

1. To enable cursors, tap **Cursors** or press the **Cursors** front-panel button.
2. One cursor is controlled by Multipurpose knob a.
3. The other cursor is controlled by Multipurpose knob b.
4. Double-tap the reference cursor to open the **Cursors** menu.
5. To bring the reference cursor to the center of the screen, tap **Reference To Center**.
6. To change the readouts from Absolute to Delta readouts for frequency and amplitude, tap Readout **Delta**.
7. To change the readout units, double-tap the **RF** badge to open the **RF** menu, and then tap **Units** and select the desired units from the list.

Use the Arbitrary Function Generator

The instrument contains an optional integrated arbitrary function generator (AFG).

The AFG is useful for simulating signals within a design or adding noise to signals to perform margin testing.

The function generator provides output of predefined waveforms up to 50 MHz. Choose between sine, square, pulse, ramp/triangle, DC, noise, $\sin(x)/x$ (Sinc), Gaussian, Lorentz, exponential rise/fall, Haversine, and cardiac signals.

The AFG can generate up to 131,072 points of an arbitrary waveform. You can create the waveform from any of the four internal ARB memories, the four (or two) analog channels, the four (or two) reference waveforms, the math waveform or the 16 digital channel waveforms. You can also use a .CSV (spreadsheet) file stored externally or a predefined template.

For waveform manipulation, you can use Tektronix' ArbExpress PC-based waveform creation and editing software. It is available for free download from www.tektronix.com/software. Use version 3.1 or later with this instrument

How to access the AFG

To access the AFG output, connect your cable to the port marked AFG OUT in the back of the oscilloscope.

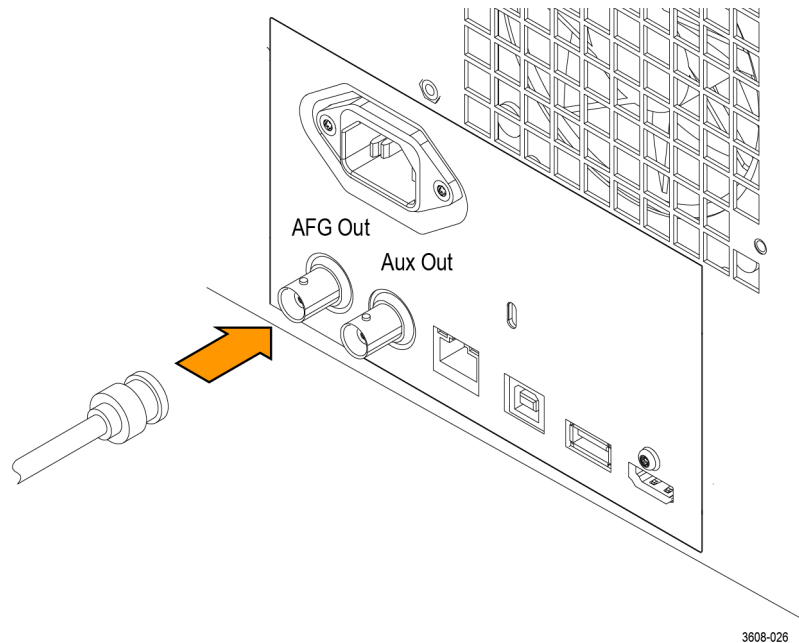

To see the output of the AFG, connect the other end of the cable to one of the input channels on the front of the oscilloscope.

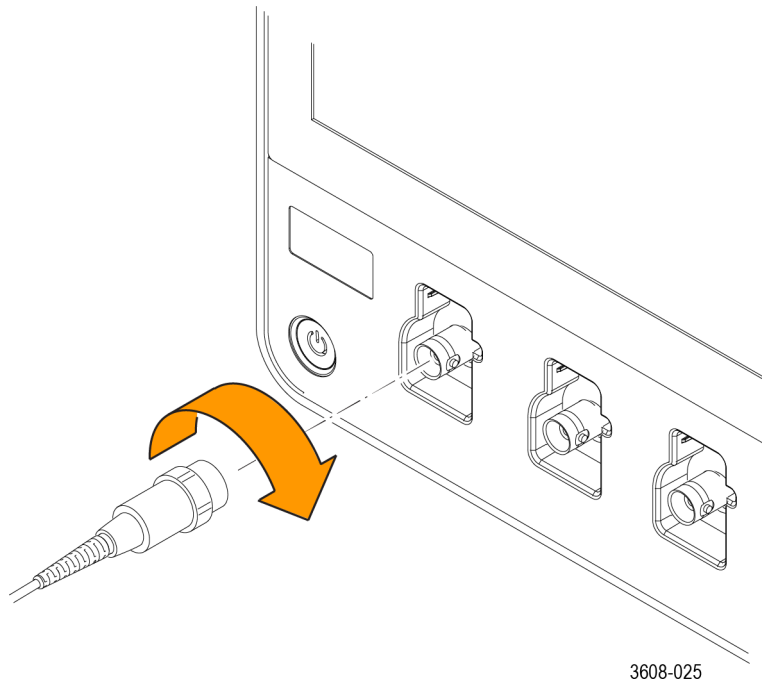

3608-025

Tap the **AFG** button to display the AFG menu.

Tap **Output** to toggle the AFG output on and off and display the AFG badge.

The AFG badge is displayed when the output is on. The On-Off status is always off when you recall an instrument setup. The AFG will always come up in the off state when you turn the oscilloscope power on.

Tap **Modulation** to toggle the AM/FM modulation on and off.

The modulation menu is not available when the AFG waveform type is set to DC, Pulse, Noise, or Cardiac.

How to change the waveform type

1. Tap the **AFG** button to bring up the AFG menu.
2. Tap **Waveform Type** and select the waveform type from the list. Choose between Sine, Square, Pulse, Ramp, DC, Noise, Sin(x)/x, Gaussian, Lorentz, Exponential Rise, Exponential Decay, Haversine, Cardiac, and Arbitrary.
3. Tap **Frequency**, **Period**, **Amplitude**, **Offset**, **High Level**, or **Low Level** and set the frequency, period, amplitude, offset and the high and low levels of the desired waveform.
4. Tap **Load Impedance** and select the load impedance: 50Ω or High Z.
5. Tap **Add Noise** check box to toggle noise on. Set the amount of noise to add to the output signal using the keypad or the multipurpose controls.

You can enable the AFG trigger pulse to come out of the rear-panel AUX OUT port. This is useful if you want an AUX OUT pulse that is synchronized to your AFG waveform. To enable this feature, tap Utility > I/O > Aux Out > AFG Out Signal > AFG Sync.

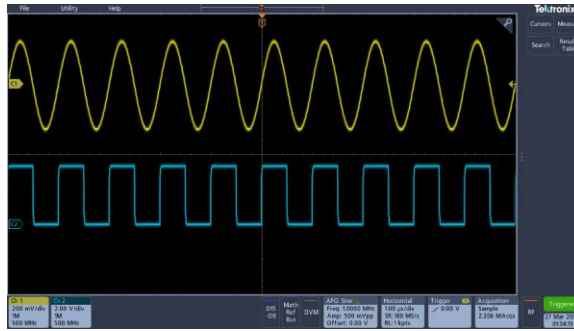

Figure 9: The channel 1 sine wave shows the output of the AFG. The channel 2 square wave show the output of the AFG sync pulse. It comes from the AUX OUT port.

Restrictions	The output waveform (MHz) frequency setting	AFG trigger output frequency (MHz)
When an output frequency is higher than 4.9 MHz, some restrictions exist. A divided frequency that is lower than 4.9 MHz is output from the AUX OUT port. The AFG trigger frequency will be limited as shown in the table to the right.	≤ 4.9 MHz	Signal frequency
	>4.9 MHz to 14.7 MHz	Signal frequency / 3
	>14.7 MHz to 24.5 MHz	Signal frequency / 5
	>24.5 MHz to 34.3 MHz	Signal frequency / 7
	>34.3 MHz to 44.1 MHz	Signal frequency / 9
	>44.1 MHz to 50 MHz	Signal frequency / 11

How to load an arbitrary waveform

You can load the waveform from the four (or two) analog channels, the four (or two) reference waveforms, the math waveform, or the 16 digital channel waveforms. You can also use a .CSV (spreadsheet) file stored externally or a predefined template (square, sine, ramp, pulse, or noise).

1. Tap the **AFG** button to display the AFG menu.
2. Tap **Waveform Type** and **Arbitrary** from the list of waveforms in the menu.
3. Tap **Frequency**, **Period**, **Amplitude**, **Offset**, **High Level**, or **Low Level** and set the frequency, period, amplitude, offset and the high and low levels of the desired waveform.
4. If you will load one of the channel, reference, or math waveforms, tap **Load From** and select the waveform source from the list.
5. Push **OK Load Waveform** to load the new waveform.
6. If you select to load from a file, tap **Browse** and browse the directory for the file.
7. Push **OK Load Waveform** to load the new waveform.
8. View your arbitrary waveform on the oscilloscope display.

Quick Tips

- You can load an arbitrary waveform from a .CSV format file. A .CSV file consists of sets of waveform point pairs (voltage, point number).
- You can load arbitrary waveforms from a variety of active time domain waveform sources: Channel 1 - 4, Ref 1 - 4, MATH, digital channels D0 - D15.

NOTE. Load impedance scales the vertical settings to show what the load would see based on the load impedance. Since the AFG is a 50 Ω source, for most accurate operation, set the load impedance to 50 Ω and set the input channel to 50 Ω .

NOTE. Noise range is reduced above 50% of the function Maximum Amplitude according to the function

*Noise Percent Maximum = 100.0 * (Maximum Amplitude / Amplitude - 1.0)*

Triggering concepts

Overview

User-defined trigger conditions are used to capture waveforms for measurement and analysis. This instrument has simple edge triggers as well as a variety of advanced triggers.

The trigger event

The trigger event establishes the time-zero point in the waveform record. All waveform record data are located in time with respect to that point. The instrument continuously acquires and retains enough sample points to fill the pre-trigger portion of the waveform record (that part of the waveform that is displayed before, or to the left of, the triggering event on screen).

When a trigger event occurs, the instrument starts acquiring samples to build the post-trigger portion of the waveform record (displayed after, or to the right of, the trigger event). Once a trigger is recognized, the instrument will not accept another trigger until the acquisition is complete and the holdoff time has expired.

Trigger sources

The trigger source provides the signal that triggers acquisition.

Use a trigger source that is synchronized with the signal that you are acquiring and displaying.

You can derive your trigger from the following sources:

- **Input channels.** Analog input channels are the most commonly used trigger sources. You can select any of the input channels. The channel that you select as a trigger source will function whether it is displayed or not.
- **Digital channels.** These sources are available if you have the MSO option and a digital probe connected. You can select any combination of digital channels.
- **Bus.** This source is used to trigger a parallel bus or a serial bus. You can include any combination of analog or digital channels to build a parallel bus, or use any channel as a component in a serial bus.

Trigger types

Select a trigger type to synchronize your acquisitions.

The available trigger types include:

Edge. This is the simplest and most commonly used trigger type, used with both analog and digital signals. An edge trigger event occurs when the trigger source passes through a specified voltage level in the specified direction (rising, falling, or either signal voltage).

Pulse Width. Trigger on pulses that are inside or outside a specified time range. Can trigger on positive or negative pulses.

Timeout. Trigger when no edge transition is detected within a specified time.

Runt. Use Runt trigger to trigger on a pulse amplitude that crosses one threshold but fails to cross a second threshold before recrossing the first. Can detect positive or negative runts, or only those wider than, less than, greater than, equal to, or not equal to a specified width.

Logic. These are special-purpose triggers that are primarily used with digital logic signals. Logic triggers are available on the main triggers. Triggering occurs when the selected condition goes true. You can also select triggering when the condition goes false, or time-qualified triggering.

Setup & Hold. Trigger when a logic input changes state inside the setup and hold times relative to the clock. This type triggers on a setup and hold violation.

Rise/Fall Time. Trigger on pulse edges that traverse between two thresholds at faster or slower rates than the specified time. The pulse edges can be positive or negative.

Sequence. Use the A Trigger Event with the B Trigger Event to capture complex data. Both the A and B trigger events must be edge triggers and rising or falling slopes.

- Time. After the A Event occurs, the trigger system waits the specified amount of time, and then looks for the B Event before triggering and displaying the waveform.
- Events. After the A Event occurs, the trigger system looks for a specified number of B Events before triggering and displaying the waveform.

Video Trigger on specified fields or lines of a composite video signal. Only composite signal formats are supported. Trigger on NTSC, PAL, or SECAM. Works with Macrovision signals. Trigger on a variety of HDTV video standard signals, as well as custom (non-standard) bilevel and trilevel video signals with 3 to 4,000 lines.

Bus. This trigger is used with both analog and digital signals to set up parallel buses or serial buses. A bus trigger event occurs when the instrument detects a bus pattern that you specify for a parallel bus, or a bus cycle you select for a serial bus. A bus is defined in a bus menu. Serial buses are optional, see [Serial bus decode and trigger options](#) on page 9.

Trigger modes

The trigger mode determines how the instrument behaves in the absence of a trigger event:

- **Normal** trigger mode enables the instrument to acquire a waveform only when it is triggered. If no trigger occurs, the instrument does not acquire a waveform, and the last waveform record acquired remains on the display. If no last waveform exists, no waveform is displayed.
- **Auto** trigger mode enables the instrument to acquire a waveform even if a trigger does not occur. Auto mode uses a timer that starts after a trigger event occurs. If another trigger event is not detected before the time out, the instrument forces a trigger. The length of time it waits for a trigger event depends on the time base setting.

Auto mode, when forcing triggers in the absence of valid triggering events, does not synchronize the waveform on the display. In other words, successive acquisitions are not triggered at the same point on the waveform; therefore, the waveform will appear to roll across the screen. If valid triggers occur, the display will become stable.

Trigger holdoff

Trigger holdoff can help stabilize triggering. When the instrument recognizes a trigger event, it disables the trigger system until acquisition is complete. In addition, the trigger system remains disabled during the holdoff period that follows each acquisition. Adjust holdoff to obtain stable triggering when the instrument is triggering on undesired trigger events.

A digital pulse train is a good example of a complex waveform. Each pulse looks like any other, so many possible trigger points exist. Not all of these will result in the same display. The holdoff period allows the instrument to trigger on the correct edge, resulting in a stable display.

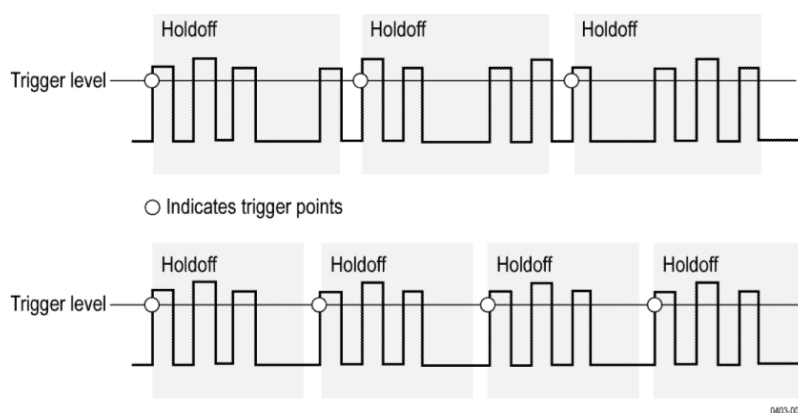

At the longer holdoff time for the top waveform, unstable triggering occurs. With a shorter holdoff set for the bottom waveform, triggers all occur on the first pulse in the burst to remedy the unstable trigger.

For more information on how to set holdoff, see [Set Trigger Holdoff](#) on page 99. If you select Auto holdoff, the instrument selects a holdoff value for you.

Trigger coupling

Trigger coupling determines what part of the signal is passed to the trigger circuit. Edge triggering can use all available coupling types: DC, Low Frequency Rejection, High Frequency Rejection, and Noise Rejection. All of the advanced trigger types use DC coupling only.

- **DC.** This coupling passes all input signals to the trigger circuitry.
- **HF Reject.** This coupling attenuates signals above 50 kHz before passing the signal to the trigger circuitry.
- **LF Reject.** This coupling attenuates signals below 50 kHz before passing the signal to the trigger circuitry.
- **Noise Reject.** This coupling provides stable triggering by increasing the trigger hysteresis. Increased hysteresis reduces the trigger sensitivity to noise but may require greater signal amplitude.

Trigger slope and level

The slope control determines whether the instrument finds the trigger point on the rising or the falling edge of a signal. The level control determines where on that edge the trigger point occurs. See the next figure.

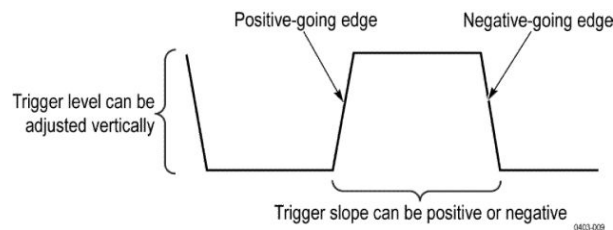

Trigger position in waveform record

Trigger position is an adjustable feature that defines where the trigger occurs on the waveform record. It lets you choose how much the instrument acquires before and after the trigger event. The part of the record that occurs before the trigger is the pretrigger portion. The part that occurs after the trigger is the posttrigger portion. A longer posttrigger period may be useful when you want to see the effects an event has on your system under test.

Pretrigger data can be valuable when troubleshooting. For example, if you are trying to find the cause of an unwanted glitch in your test circuit, you can trigger on the glitch and make the pretrigger period large enough to capture data before the glitch. By analyzing what happens before the glitch, you may uncover information that helps you find the source of the glitch.

Trigger delay

Use the Trigger Delay to trigger the instrument a specified period of time after the A trigger. After the A trigger arms the trigger system, the instrument triggers on the next B trigger event that occurs after the time that you specify.

You can trigger with the A trigger system alone or you can combine the A trigger with the B (Delayed) trigger to trigger on sequential events. When using sequential triggering, the A trigger event arms the trigger system, and the B trigger event triggers the instrument when the B trigger conditions are met.

A and B triggers can (and typically do) have separate sources. The B trigger condition can be based on a time delay or a specified number of counted events.

Bus triggering concepts

A bus trigger occurs when a supported instrument detects a bus pattern that you specify for a parallel bus, or a bus cycle you select for a serial bus.

You can set the instrument to trigger on a parallel bus when the instrument detects a match to the bus pattern, or when the instrument detects that the value on the bus is < or > the value of the bus pattern. The pattern can be in Binary or Hex format.

You can set the instrument to trigger on an SPI bus when the instrument detects an SS Active bus cycle or Data.

You can set the instrument to trigger on an I2C bus when the instrument detects a Start, Stop, Repeated Start, Missing Ack, Address, Data, or Addr + Data bus cycle or activity.

You can set the instrument to trigger on a USB bus (Low and Full Speed USB) when the instrument detects a Sync, Reset, Suspend, Resume, End of Packet, Token (Address) Packet, Data Packet, Handshake Packet, Special Packet, or Error bus cycle or activity.

You can set the instrument to trigger on an RS232 bus when the instrument detects a Start, End of Packet, Data, or Parity Error bus cycle or activity.

You can set the instrument to trigger on a CAN bus when the instrument detects a Start of Frame, Type of Frame, Identifier, Data, Id and Data, End of Frame, Missing Acq, FD bit, or Bit Stuffing Error bus cycle or activity.

You can set the instrument to trigger on a LIN bus when the instrument detects a Sync, Identifier, Data, Identifier & Data, Wakeup Frame, Sleep Frame, or Error bus cycle or activity.

You can set the instrument to trigger on a FlexRay bus when the instrument detects a Start of Frame, Indicator Bits, Identifier, Cycle Count, Header Fields, Data, Identifier & Data, End of Frame, or Error bus cycle or activity.

You can set the instrument to trigger on an AUDIO bus when the instrument detects a Word Select, Frame Sync, or Data bus cycle or activity.

For all the serial standard buses, you can also set the component threshold levels through the Bus Setup menu

Pulse width trigger concepts

A pulse width trigger occurs when the instrument detects a pulse that is less than, greater than, equal to, or not equal to a specified time. Additionally, you can trigger when a pulse width is within or outside a range of two different specified times. The instrument can trigger on positive or negative width pulses.

Timeout trigger

A timeout trigger occurs when the instrument does not detect an expected pulse transition within a user specified period of time, such as when a signal gets stuck either high or low. If the pulse transition occurs prior to a specified timeout time (the expected case), then no trigger results.

Runt trigger

A runt trigger occurs when the instrument detects a short pulse that crosses one threshold but fails to cross a second threshold before recrossing the first. You can set the instrument to detect any positive or negative runt pulse, or only those wider than a specified minimum width.

Logic trigger concepts

Logic trigger the instrument when all channels transition to the specified state. You can set each bit to be active High, Low, or Don't Care. You can also set the logic thresholds and define the logic (AND, OR, NOR, or NAND).

Setup and Hold trigger concepts

A setup/hold trigger occurs when a data signal changes state inside of the user specified setup and hold times relative to the clock. When you use setup/hold triggering, you define:

- The channel containing the logic input (the data source) and the channel containing the clock (the clock source)
- The direction of the clock edge to use
- The clocking level and data threshold that the instrument uses to determine if a clock or data transition has occurred
- The setup and hold times that together define a time range relative to the clock

Data that changes state within the setup/hold violation zone triggers the instrument. The next figure shows how the setup and hold times that you choose position the violation zone relative to the clock.

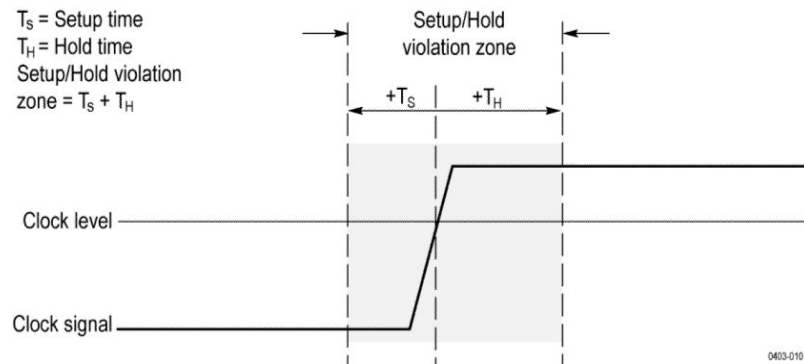

Setup/hold triggering uses the setup/hold violation zone to detect when data is unstable too near the time it is clocked. Each time trigger holdoff ends, the instrument monitors the data and clock sources. When a clock edge occurs, the instrument checks the data stream it is processing (from the data source) for transitions occurring within the setup/hold violation zone. If any occur, the instrument triggers with the trigger point located at the clock edge.

The setup/hold violation zone spans the clocking edge as shown above. The instrument detects and triggers on data that does not become stable long enough before the clock (setup time violation) or that does not stay stable long enough after the clock (hold time violation).

Rise/Fall time trigger concepts

Rise/Fall time triggering is based on the slope (change in voltage/change in time) of a pulse edge. Trigger on pulse edges that traverse between two thresholds at faster or slower rates than the specified time.

Use the Rise/Fall time trigger to trigger the instrument on pulse edges that traverse between two thresholds at faster or slower rates than the specified time. You can set up the instrument to trigger on positive or negative edges.

Sequential (A B) trigger concepts

In applications that involve two or more signals, you may be able to use sequential triggering to capture more complex events. Sequential triggering uses the A (Main) trigger to arm the trigger system, and then uses the B (Delayed) trigger to trigger the instrument if a specific condition is met. Both the A trigger and the B trigger must be Edge triggers.

You can choose one of two trigger conditions:

- **Trigger after a Delay.** After the A trigger arms the trigger system, the instrument triggers on the next B-trigger event that occurs after the trigger delay time. You can set the trigger delay time with the keypad or a multipurpose knob.
- **Trigger on the Nth event.** After the A trigger arms the trigger system, the instrument triggers on the Nth B event. You can set the number of B events with the keypad or a multipurpose knob.

NOTE. *The traditional delayed trigger mode called **Runs After** is controlled by the **Horizontal Delay** feature. You can use horizontal delay to delay acquisition from any trigger event, whether from the A trigger alone or from a sequential trigger that uses both the A and B triggers.*

Waveform display concepts

Waveform display overview

This instrument includes a flexible, customizable display that lets you control how waveforms appear. The figure shows how the display features fit into the overall instrument operation.

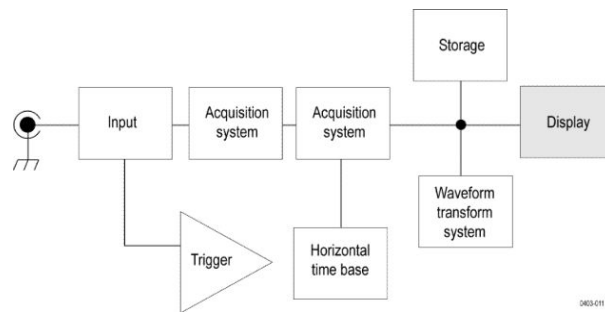

The display shows analog, digital, math, reference and bus waveforms. The waveforms include channel markers and trigger source and level indicators.

Waveform preview mode

The waveform preview attempts to show what the next acquisition will look like when the acquisition is delayed due to slow triggers or long acquisition duration, or when the acquisitions have stopped. Waveform preview recalculates math waveforms, but does not represent changes in trigger levels, trigger modes, or different acquisition modes.

Horizontal position and the horizontal reference point

The time value you set for horizontal position is measured from the trigger point to the horizontal reference point. This is not the same as the time value from the trigger point to the start of the waveform record, unless you set the horizontal reference to 0%. See the next figure.

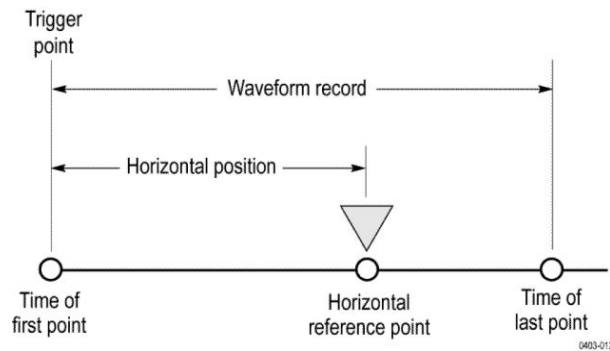

Annotating the screen

You can add your own text to the screen.

Doing the following to add your own text to the screen:

1. Double-tap an empty location on the screen to display the Waveform view menu.
2. Double tap Screen Annotation to display the keyboard.
3. Enter the desired text using the keyboard.
4. Tap Enter to display the text and close the keyboard.
5. Tap and drag the text to the desired location.

Measurement concepts

Taking automatic measurements in the time domain

This topic explains how to take an automatic measurement in the time domain.

To take an automatic measurement in the time domain:

1. If the instrument is in the frequency domain, tap the **2** button or push the channel 1 front panel button.
2. Tap **Measure** to display the Add Measurements menu.
3. Tap a measurement category panel to display available measurements.
4. Tap Source and select the desired source for the measurement.
5. Tap the desired measurement.
6. Tap **Add** to create the measurement results badge.
7. To remove a measurement, tap the measurement results badge and flick it off the display.

Quick Tips

- A symbol and Clipping appears if a vertical clipping condition exists. Part of the waveform is above or below the display. To obtain a proper numerical measurement, turn the vertical scale and position knobs to make all of the waveform appear in the display.
- If the oscilloscope displays an error message, change the instrument setup, such as increasing the record length of the acquisition or changing the horizontal scale so that the instrument has more points or edges from which to calculate the measurement.

Taking automatic measurements in the frequency domain

This topic explains how to take an automatic measurement in the frequency domain.

To take an automatic measurement in the frequency domain:

1. If the instrument is in the time domain, tap the **RF** button or push RF front-panel button.
2. Tap **Measure** to display the Add Measurements menu.
3. Tap the measurement of interest from the menu. As you select each frequency measurement, on screen help will appear to explain the purpose of that measurement.
 - **Channel Power**: The total power within the bandwidth, defined by the Channel Width.
 - **Adjacent Channel Power Ratio**: The power in the main channel and the ratio of channel power to main power, for the upper and lower halves of each adjacent channel.
 - **Occupied Bandwidth**: The bandwidth that contains the specified % of power within the analysis bandwidth.
4. Tap **Add** to create the measurement results badge.
5. To configure the measurement, double-tap the measurement badge.
6. After you set the measurement parameters in the resulting menu, the instrument will automatically set the span. When the RF measurements are on, the Auto detection method will set all frequency domain traces to the Average detection method. This provides optimal measurement accuracy.

Taking digital voltmeter measurements

Use the digital voltmeter to measure the potential difference between two points in an electrical circuit.

Use this procedure to take digital voltmeter measurements.

1. Tap the **DVM** button to display the DVM results badge.
2. Double-tap the **DVM** results badge to display the DVM menu.
3. Tap the **Display** field to toggle the digital voltmeter on and off.
4. Tap the **Source** field and select the source from the drop-down list. Measurements will be taken on this source.
5. Tap the **Mode** field and select the measurement type you want to take: DC, AC RMS, AC+DC RMS, or Frequency.
6. Tap **Show Basic Statistics in Badge** to display statistics in the measurement badge.
7. Tap an empty location on the display to close the DVM menu.

View the finished results in the DVM results badge.

Taking manual measurements with cursors

Cursors are on-screen markers that you position in the waveform display to take manual measurements on acquired data.

To take manual measurements with cursors in the frequency domain, see [Frequency domain cursors](#) on page 297.

Cursors appear as horizontal and/or vertical lines. To use cursors on analog or digital channels:

1. Tap the **Cursors** on-screen button or push the Cursors front-panel button.

NOTE. A second tap or push turns cursors off.

As you turn Multipurpose a, you move one cursor to the right or left. As you turn Multipurpose b, you move the other cursor.

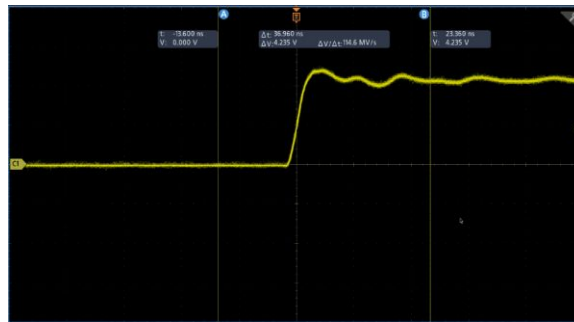

2. Double-tap a cursor to display the cursor menu.
3. Tap **Cursor Mode**. Selecting Independent allows the a and b cursors to move independently.

Selecting Linked turns the cursor linking on. If linking is on, turning Multipurpose knob a moves the two cursors together. Turning Multipurpose knob b adjusts the time between the cursors.

4. Push a Multipurpose knob to toggle between a coarse and a fine adjustment for the Multipurpose knobs.
5. Double-tap a cursor to display the cursor menu.
6. Tap **Cursor Type** and select Screen from the list.

In Screen mode, two horizontal bars and two vertical bars span the graticule.

- Tap a horizontal cursor. Turn Multipurpose a and Multipurpose b to move the pair of horizontal cursors.

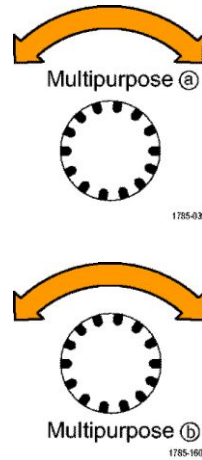

- Tap a vertical cursor.

This makes the vertical cursors active and the horizontal cursors inactive. Now, as you turn the multipurpose knobs, the vertical cursors will move.

Tap a horizontal cursor to make the horizontal cursors active again.
- View the cursor and the cursor readout.

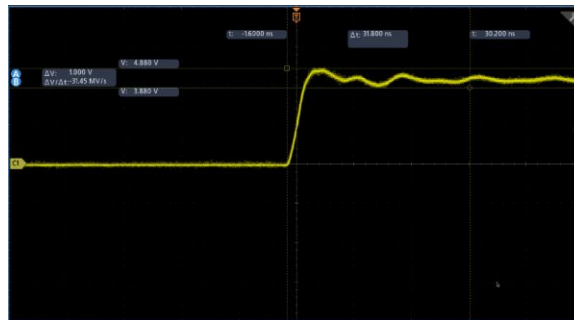

NOTE. On digital channels, you can take timing measurements with cursors, but not amplitude measurements.

- Display multiple waveforms on the screen by pushing one or more of the channel buttons or by pushing the **Digital** button.
- Double-tap a cursor to display the cursor menu again.
- Tap the **Source** button and select a source from the list. The default menu selection of Selected Waveform will cause the cursors to take measurements on the selected (last used) waveform.
- Tap the **Source** button and select a source from the list to measure other than the one pointed to by Selected Waveform.
- Tap outside the menu to remove the menu.
- Tap or push **Cursors** again. This turns off the cursors. The screen no longer displays the cursors and the cursor readout.

Making automated power measurements

This topic explains how to take an automatic power measurement (optional).

Acquire, measure, and analyze power signals with the 3-PWR Power Measurement and Analysis option. To use this application:

1. Tap **Measure** to display the Add Measurements menu.
2. Tap the **Power Measurements** panel.
3. Tap **Source 1** and **Source 2** and select the desired sources for the measurement.
4. Tap the desired measurement. Choose among:
 - Power quality
 - Switching loss
 - Harmonics
 - Ripple
 - Modulation
 - Safe operating area
5. Tap **Add** to create the measurement results badge. View the measurement results in the results badge.
6. To remove a measurement, tap the measurement results badge and flick it off the display.
7. To configure the measurement, double-tap the **Power** results badge to display the measurement configuration menu. See [The Power Measurements panel \(optional\)](#) on page 123 for more information.

Using cursor readouts

Cursor readouts supply textual and numeric information relating to the current cursor positions.

The instrument shows the readouts when the cursors are turned on. Readouts appear in the upper portion of the graticule attached to the cursors.

When a bus is selected, the readout shows the decoded bus data in the format you have selected from the choices in the bus menu. When a digital channel is selected, the cursors show the values of all displayed digital channels.

NOTE. *When serial or parallel buses are selected, the data value at that point is displayed in the cursor readout.*

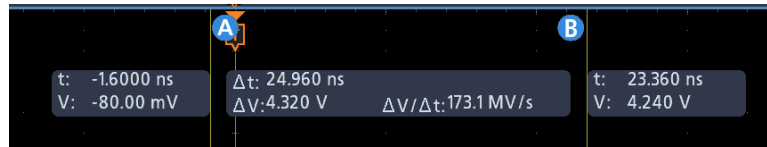

- **Δ Readout:** Indicates the difference between the cursor positions.
- **a Readout:** Indicates that the value is controlled by the Multipurpose a knob.
- **b Readout:** Indicates that the value is controlled by the Multipurpose b knob.

The horizontal cursor lines on the display measure the vertical parameters, typically voltage.

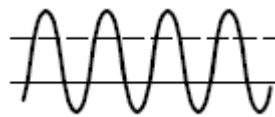

The vertical cursor lines on the display measure horizontal parameters, typically time.



The square and circle shapes in the readout map to the multipurpose knobs when both vertical and horizontal cursors are present.

Using XY Cursors

When the XY Display mode is on, the cursor readouts appear at the right of the display.

The oscilloscope displays rectangular, a, b, and the Δ readouts.

Measurement variables

By knowing how the instrument makes calculations, you may better understand how to use your instrument and how to interpret your results. The instrument uses a variety of variables in its calculations. These include:

Definition of Base and Top

Base is the value used as the 0% level in measurements such as fall time and rise time.

Top is the value used as the 100% level in measurements such as fall time and rise time. For example, if you set the 10% to 90% rise time, then the instrument calculates 10% and 90% as percentages of Top and Base, with Top representing 100%.

The exact value of Base and Top depends on which Base Top Method you select in the Reference Levels panel of a Measurement configuration menu. It also depends on if you set the reference level to be Global (applies to all measurements set as Global in the Reference Levels panel), or Local (just applies to the measurement that is set to Local).

Base, Top calculation methods

The Base Top calculation method is set in the Reference Levels panel of a Measurement configuration menu.

Auto is the default method, and automatically determines the best Base Top method to use. Most commonly sets the Base Top method to Histogram Mode.

MinMax defines the 0% and the 100% waveform levels as the lowest value and the highest value samples of the waveform record. This setting is best for examining waveforms that have no large, flat portions at a common value, such as sine waves and triangle waves - almost any waveform except for pulses.

The MinMax method calculates the Top and Base values as follows:

Top = Max

and

Base = Min

Histogram uses histogram analysis to select the most common values either above or below the midpoint. Since this statistical approach ignores short-term aberrations (overshoot, ringing, and so on), Histogram is the best setting for examining pulses.

HighRef, MidRef, LowRef

You set the various reference levels, through the Reference Levels tab of the Measure menu. They include:

High is the waveform high reference level (also HighRef). Used in all measurements. Typically set to 90%. You can set it from 0% to 100% or to a voltage level.

Mid is the waveform middle reference level (also MidRef). Mid reference levels are used in all measurements that need to find edges. Typically set to 50%. You can set it from 0% to 100% or to a voltage level.

Low is the waveform low reference level (also LowRef). Used in all measurements. Typically set to 10%. You can set it from 0% to 100% or to a voltage level.

High, mid and low reference levels can be set uniquely for each measurement source. Reference levels can also be set differently for rising edge detection and falling edge detection.

Other variables

The instrument also measures several values itself that it uses to help calculate measurements.

Record Length is the number of data points in the time base. You set it with the Horizontal menu Record Length item.

Start is the location of the start of the measurement zone (X-value). It is 0.0 samples unless you are making a gated measurement. When you use cursor gated measurements, it is the location of the left vertical cursor.

End is the location of the end of the measurement zone (X-value). It is $(RecordLength - 1.0)$ samples unless you are making a gated measurement. When you use cursor gated measurements, it is the location of the right vertical cursor.

Edge calculations

Edge1, Edge2, and Edge3 refer to the first, second, and third *Mid* reference edge times, respectively.

An edge can be detected when the waveform is either rising or falling past Midref. The direction of the edges alternates, that is, if Edge1 is rising, Edge2 will be falling.

A rising edge has positive polarity. A falling edge has negative polarity.

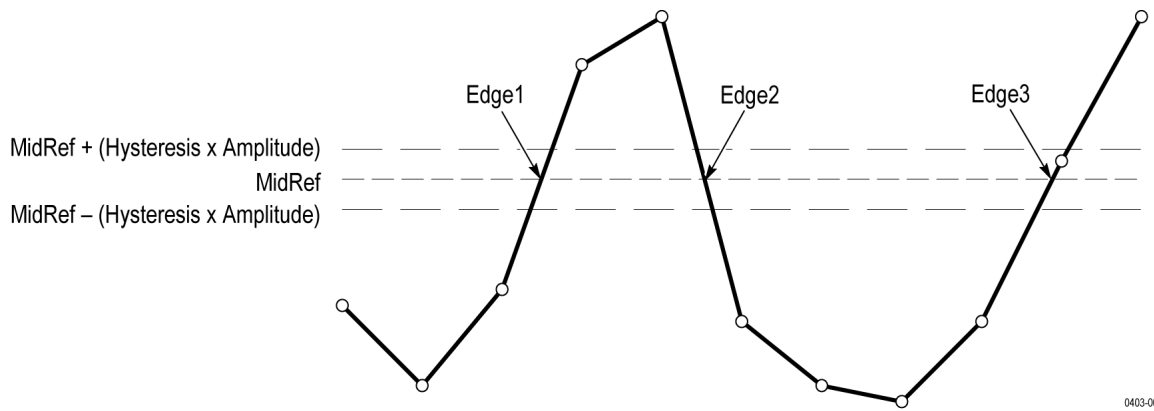

Missing or out-of-range samples

If some samples in the waveform are missing or off-scale, the measurements will interpolate between known samples to make an appropriate guess as to the sample value. Missing samples at the ends of the measurement record will be assumed to have the value of the nearest known sample.

When samples are out of range, the measurement will give a warning to that effect (for example, CLIPPING) if the measurement could change by extending the measurement range slightly. The algorithms assume the samples recover from an overdrive condition instantaneously.

Math waveforms

Once you have acquired waveforms or taken measurements on waveforms, the instrument can mathematically combine them to create a waveform that supports your data-analysis task. For example, you might have a waveform clouded by background noise. You can obtain a cleaner waveform by subtracting the background noise from your original waveform. Or, you can integrate a single waveform into an integral math waveform

With spectral analysis you can analyze waveforms in the frequency domain.

This instrument supports mathematical combination and functional transformations of waveforms it acquires.

You create math waveforms to support the analysis of your channel and reference waveforms. By combining and transforming source waveforms and other data into math waveforms, you can derive the data view that your application requires. Create math waveforms that result from:

- Mathematical operations on one or several waveforms: add, subtract, multiply, and divide.
- Functional transformations of waveforms, such as integration, differentiation, and so on.
- Spectral analysis of waveforms, such as testing impulse response.

Math waveform elements

You can create Math waveforms from the following:

- Channel waveforms
- Reference waveforms
- Measurement scalars (automated measurements) that measure channel, reference, or math waveforms.
- Other math waveforms
- Variables

Dependencies

In general, math waveforms that include sources as operands are affected by updates to those sources:

- Shifts in amplitude or DC level of input sources that cause the source to clip also clip the waveform data supplied to the math waveform.
- Changes to the vertical offset setting for a channel source that clips its data also clips the waveform data supplied to the math waveform.

- Changes to the acquisition mode globally affects all input channel sources, modifying any math waveforms using them. For example, with the acquisition mode set to Envelope, a Ch1 + Ch2 math waveform will receive enveloped channel 1 and channel 2 data, and will also be an envelope waveform.
- Clearing the data in a waveform source causes a baseline (ground) to be delivered to any math waveform that includes that source until the source receives new data.

Guidelines for working with math waveforms

Remember guidelines when working with math waveforms.

Use the following guidelines when working with math waveforms:

- Keep math waveforms simple.
- Math calculations are not available on digital channels.
- To avoid syntax errors in a math expression, verify the use of operators, parentheses, operands, and the spelling of functions.
- If one or more reference waveforms are used in a math waveform, the record length is equal to the smallest of all the source waveforms (reference or channel waveforms). The math is calculated using the first point from each source, followed by the next point, and so forth. This is true even if the sources have different times between points in the record.

Math waveform editor syntax

You can build math waveforms using the predefined expressions or the equation editor.

To help you create valid math waveforms, the following tools block most illegal entries by disabling any window element that would create an invalid entry in the math waveform expression.

Predefined expressions are accessible using the FFT or Basic Math Types.

The following syntax describes the valid math expressions you can use with the Equation Editor for the Advanced Math Type:

A math expression is composed of settings, functions, scalars and sources.

Functions, except for basic and logic functions, have the syntax function(source).

Basic and logic functions have the syntax source1 function source2.

Examples: Ch1 * Ch2

Ch1 >= Ch2

Logic functions, ==|<|>|!=|<=|>= result in a waveform consisting of binary 0 and 1 values.

Scalars can be integers, floating point values, PI or meas<x>.

Sources can be Ch<x> or Ref<x>

Math waveform differentiation

The math capabilities of the instrument include waveform differentiation.

Waveform differentiation allows you to display a derivative math waveform that indicates the instantaneous rate of change of the acquired waveform.

Derivative waveforms are used in the measurement of slew rate of amplifiers and in educational applications.

The math waveform, derived from the sampled waveform, is computed based on the following equation:

$$Y_n = \frac{X_{(n+1)} - X_n}{T}$$

Where: **X** is the source waveform, **Y** is the derivative math waveform, and **T** is the time between samples.

Since the resultant math waveform is a derivative waveform (see the next figure), its vertical scale is in volts/second (its horizontal scale is in seconds). The source signal is differentiated over its entire record length; therefore, the math waveform record length equals that of the source waveform.

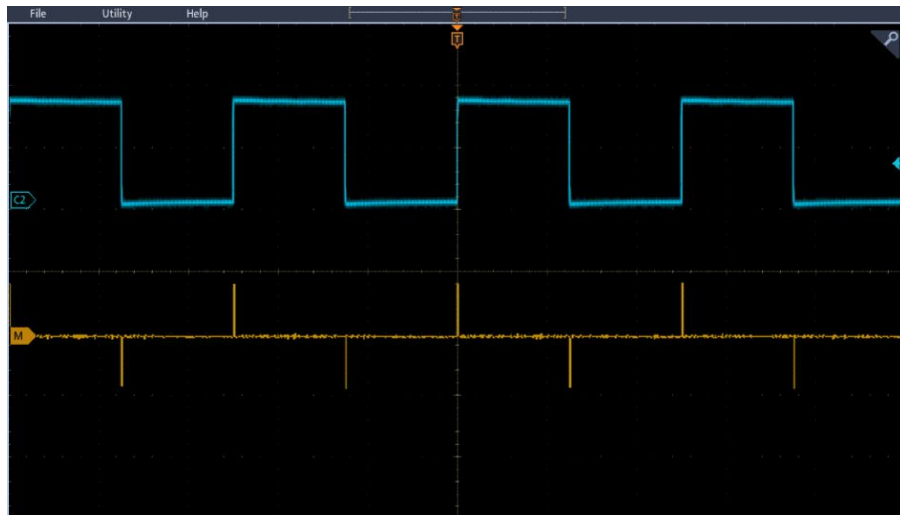

Math waveform offset position and scale

The settings that you make for offset, scale, and position affect the math waveform you obtain.

Here are some tips for obtaining a good display:

- Scale and position the source waveform so that it is contained on the screen. (Off-screen waveforms may be clipped, resulting in errors in the derivative waveform).
- Use vertical position and vertical offset to position your source waveform. The vertical position and offset will not affect your derivative waveform unless you position the source waveform off screen so that it is clipped.

Waveform integration

The math capabilities of the instrument include waveform integration.

This allows you to display an integral math waveform that is an integrated version of the acquired waveform.

Use integral waveforms in the following applications:

- Measuring power and energy, such as in switching power supplies.
- Characterizing mechanical transducers, as when integrating the output of an accelerometer to obtain velocity.

The integral math waveform, derived from the sampled waveform, is computed based on the following equation:

$$y(n) = scale \sum_{i=1}^n \frac{x(i) + x(i-1)}{2} T$$

Where: **x(i)** is the source waveform, **y(n)** is a point in the integral math waveform, **scale** is the output scale factor, and **T** is the time between samples.

Since the resultant math waveform is an integral waveform, its vertical scale is in volt-seconds (its horizontal scale is in seconds). The source signal is integrated over its entire record length; therefore, the math waveform record length equals that of the source waveform.

Offset and position

When creating integrated math waveforms from live channel waveforms, consider the following:

- You should scale and position the source waveform so that it is contained on screen. (Off screen waveforms may be clipped, which will result in errors in the integral waveform.)
- You can use vertical position and vertical offset to position your source waveform. The vertical position and vertical offset will not affect your integral waveform unless you position the source waveform off screen so that it is clipped.

DC offset

The source waveforms that you connect to the instrument often have a DC offset component. The instrument integrates this offset along with the time-varying portions of your waveform. Even a few divisions of offset in the source waveform may be enough to ensure that the integral waveform saturates (clips), especially with long record lengths.

Using math waveforms

This topic helps you create basic math waveforms.

Create math waveforms to support the analysis of your channel and reference waveforms. By combining and transforming source waveforms and other data into math waveforms, you can derive the data view that your application requires.

NOTE. *Math waveforms are not available for use with serial buses.*

Math functions are available when the instrument is operating in time-domain mode.

Use the following procedure for executing basic (+, −, ×, ÷) math operations on two waveforms:

1. Tap the **Add Math Ref Bus** button and then tap **Math**. This creates a Math badge and displays the math waveform.
2. Double-tap the **Math** badge to open the Math configuration menu.
3. Tap the Math Type **Basic** button.
4. Set the sources to either channel 1, 2, 3, 4, or reference waveforms R1, 2, 3, or 4.
5. Choose the +, −, ×, or ÷ operators.
6. For example, you might calculate power by multiplying a voltage waveform and a current waveform.

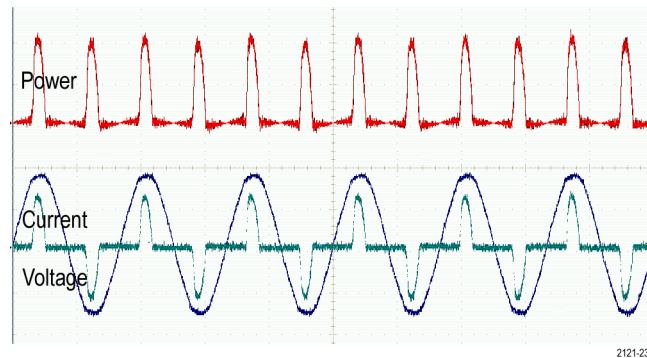

Quick Tips Math waveforms can be created from channel or reference waveforms or a combination of them.

Measurements can be taken on math waveforms in the same way as on channel waveforms.

Math waveforms derive their horizontal scale and position from the sources in their math expressions. Adjusting these controls for the source waveforms also adjusts the math waveform.

Using advanced math

The advanced math feature lets you create a custom math waveform expression that can incorporate active and reference waveforms, measurements, and/or numeric constants.

To use the advanced math feature:

1. Tap the **Add Math Ref Bus** button and then tap **Math**. This creates a Math badge and displays the math waveform.
2. Double-tap the **Math** badge to open the Math configuration menu.
3. Tap the Math Type **Advanced** button.
4. Tap the **Edit** button. The Equation Editor menu is displayed.
5. Use the Equation Editor buttons to create custom expressions.
6. When done, tap **OK**.

For example, to use Equation Editor to take the integral of a square wave:

1. Tap **Clear**.
2. Tap Functions **Intg**(.
3. Tap Sources **Ch1** to select channel 1.
4. Tap Miscellaneous **)**.
5. Tap **OK**.

Using FFT

This topic explains how to use an FFT to display a graph of the frequency domain of a signal.

An FFT function breaks down signals into component frequencies, which the oscilloscope uses to display a graph of the frequency domain of a signal, as opposed to the oscilloscope's standard time domain graph. You can match these frequencies with known system frequencies, such as system clocks, oscillators, or power supplies.

1. Tap the **Add Math Ref Bus** button and select **Math**. This adds the Math badge to the Settings bar .
2. Tap Math Type **FFT**.
3. Tap **Source** and select the source from the list. Choices are: channels 1, 2, (3, and 4 on four-channel models), reference waveforms R1, R2, (R3, and R4 on four-channel models).
4. Tap **Units** and select either Linear or dBV.
5. Tap **Window** and select the desired window. Window choices are: Rectangular, Hamming, Hanning, and Blackman-Harris.
6. Tap **Horizontal Scale** and **Horizontal Position** activate the Multipurpose a and Multipurpose b knobs to pan and zoom the FFT display.
7. The FFT will appear on the display.

Quick Tips

Use short record lengths for faster instrument response.

Use long record lengths to lower the noise relative to the signal and increase the frequency resolution.

If desired, use the zoom feature along with the horizontal Position and Scale controls to magnify and position the FFT waveform.

Use the default dBV scale to see a detailed view of multiple frequencies, even if they have very different amplitudes. Use the linear scale to see an overall view of how all frequencies compare to each other.

The math FFT feature provides a selection of windows. Each offers a trade-off between frequency resolution and magnitude accuracy. The choice of which window to use depends upon what you want to measure and your source's signal characteristics.

FFT process

An FFT waveform displays a frequency-domain view, up to the Nyquist frequency, of a time-domain signal.

The FFT process mathematically converts the standard time-domain signal (repetitive or single-shot acquisition) into its frequency components.

The FFT function processes the waveform record and displays the FFT frequency domain record, which contains the input signal frequency components from DC (0 Hz) to $\frac{1}{2}$ the sample rate (also called the Nyquist frequency).

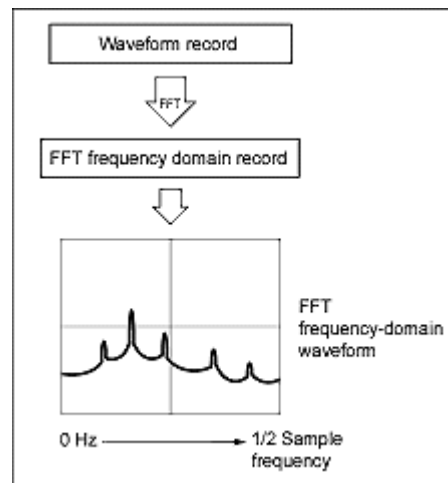

Nyquist frequency

The highest frequency that any digital oscilloscope can measure without errors is one-half of the sample rate. This frequency is called the Nyquist frequency.

The FFT waveform displays the input signal frequency components from DC (0 Hz) to the Nyquist frequency.

FFT and aliasing

Aliasing occurs when the input frequency of a signal is greater than one half of the sampling frequency (the sample rate).

Set the sample rate high enough so that the signals in the spectrum appear at their correct frequency as opposed to a lower aliased frequency value. Also, complex signal shapes that have many harmonics in them, such as a triangle or square wave, can appear to be OK in the time domain when in fact many of the harmonics in that signal are aliased.

One way to check for aliasing is to increase the sample rate and observe whether any of the harmonics unwrap to different frequency locations.

Another way to recognize aliasing is to realize that higher order harmonics usually have decreasing magnitudes compared to lower order harmonics. Thus, if you see a series of increasing harmonic magnitude values as frequency increases then you can suspect that they may be aliased. In the spectral math waveform, the actual higher frequency components are under sampled, and therefore they appear as lower frequency aliases that fold back around the Nyquist point. You may test by increasing the sample rate and observing if aliases unwrap to different frequency positions.

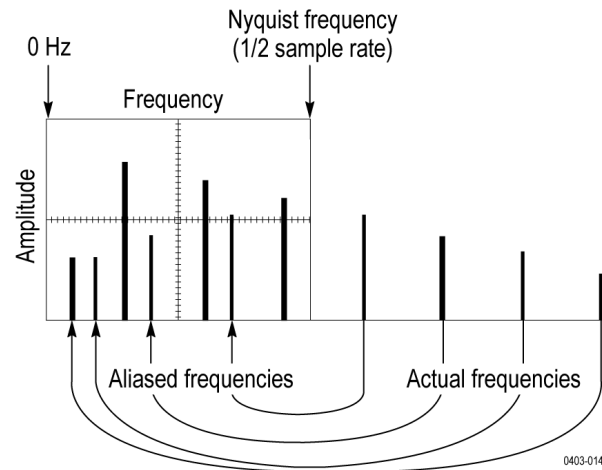

If you have a variable-frequency signal source, another way to observe aliasing is to adjust the frequency slowly while watching the spectral display. If some of the harmonics are aliased, you will see the harmonics decreasing in frequency when they should be increasing or vice versa.

Blackman-Harris FFT window concepts

The frequency resolution when using the Blackman-Harris window is poor, the spectral leakage is very low and amplitude accuracy is good.

The Blackman-Harris window has a low amount of energy leakage compared to the other windows. Its best use is for single frequency signals to look for higher order harmonics. Use the Blackman-Harris window for measuring predominantly single frequency waveforms to look for higher order harmonics, or several moderately or widely spaced sinusoidal signals.

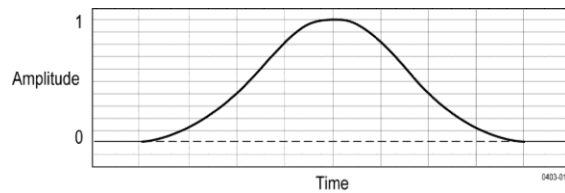

Hanning FFT window

The frequency resolution when using the Hanning window is good, the spectral leakage is low and amplitude accuracy is fair.

The Hanning window has the narrowest resolution bandwidth, but higher side lobes. Hanning has slightly poorer frequency resolution than Hamming. Hanning is best for measuring sine, periodic, and narrow-band random noise, and transients or bursts where the signal levels before and after the event are significantly different.

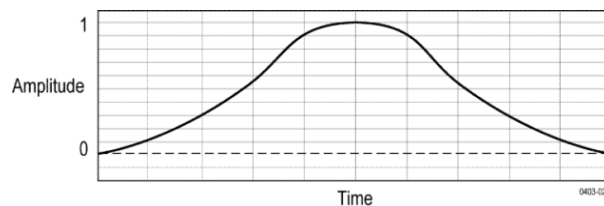

Hamming window

The frequency resolution when using the Hamming window is good (slightly better than Hanning), the spectral leakage is moderate, and amplitude accuracy is fair.

This window is unique in that the time domain shape does not taper all the way to zero at the ends. This makes it a good choice if you wanted to process the real and imaginary parts of the spectrum off line and inverse transform it back to the time domain. Because the data does not taper to zero, you can remove the effect of the window function from the result.

Use the Hamming window for measuring sine, periodic, and narrow band random noise. This window works well on transients or bursts where the signal levels before and after the event are significantly different.

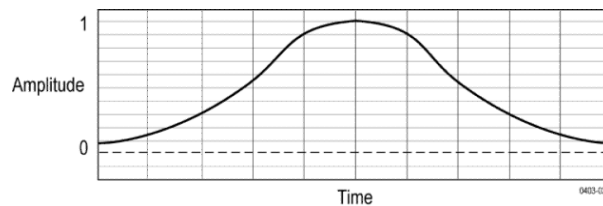

Rectangular window

The frequency resolution when using the Rectangular (a.k.a. boxcar or none) window is very good, the spectral leakage is high, and amplitude accuracy is poor.

This window is equal to unity (see the next figure). This means the data samples in the gate are not modified before input to the spectral analyzer. Rectangular windows are best for measuring transients or bursts where the signal levels before and after the event are nearly equal. Also, use this window for equal-amplitude sine waves with frequencies that are very close together, and for broadband random noise with a relatively slow varying spectrum. This window is the best type for measuring the frequency spectrum of non-repetitive signals, and measuring frequency components near DC.

NOTE. *This window has the narrowest resolution bandwidth of any of the windows, but it also has the most spectral leakage and the highest side lobes.*

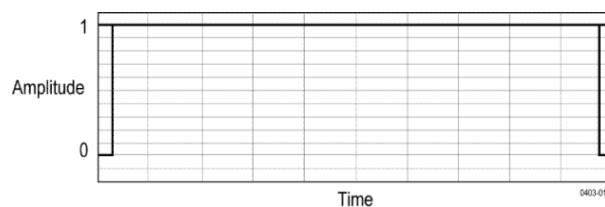

Using spectrum math

This topic describes using spectrum math.

The spectrum math feature lets you create a math waveform by adding or subtracting frequency traces.

NOTE. *Spectrum Math is only available when the instrument is acquiring in Spectrum Analyzer mode.*

1. Tap the **Add Math Ref Bus** button and then tap **Math**. This creates a Math badge and displays the math waveform.
2. Double-tap the **Math** badge to open the Math configuration menu.
3. Set the **Source 1** and **Source 2** from the drop-down lists.
4. Choose the + or – operators.

The math waveform will appear on the display as a red trace.

5. Double-tap Label and use the keyboard to give your math trace an appropriate label.

NOTE. *The instrument will only complete the calculation if the units of measure of the source waveforms, when combined, make logical sense.*

References

Upgrading firmware

Use this procedure to upgrade the instrument firmware.

To upgrade the firmware of the oscilloscope:

1. Open up a Web browser and go to www.tektronix.com/software/downloads. Proceed to the software finder. Download the latest firmware for your oscilloscope on your PC.
2. Unzip the files and copy the firmware.img file into the root folder of a USB flash drive or USB hard drive.
3. Power off your oscilloscope.
4. Insert the USB flash or hard drive into the USB port on the front panel of your oscilloscope.
5. Power on the oscilloscope. The instrument automatically recognizes the replacement firmware and installs it.

NOTE. Do not power off the oscilloscope or remove the USB drive until the oscilloscope finishes installing the firmware.

If the instrument does not install the firmware, rerun the procedure. If the problem continues, try a different model of USB flash or hard drive. Finally, if needed, contact qualified service personnel.

6. When the upgrade is complete, power off the oscilloscope and remove the USB flash or hard drive.
7. Power on the oscilloscope.
8. Tap **Help** and select **About**. The oscilloscope displays the firmware version number.
9. Confirm that the version number matches that of the new firmware.

Cleaning

Use a dry, soft cotton cloth to clean the outside of the unit. If any dirt remains, use a cloth or swab dipped in a 75% isopropyl alcohol solution. Use a swab to clean narrow spaces around controls and connectors. Do not use any liquid cleaning agents or chemicals that could damage the touchscreen, case, controls, markings or labels, or possibly infiltrate the case.

Index

250 Kohm termination,

3-SEC

enhanced instrument security option, 9

A

A B Sequence trigger,

A knob, 25

about the instrument,

AC line voltage, 303

accessories. standard, 3

accessory pouch, 3

Acquired waveform, 285

acquiring a signal, 67

Acquisition

input channels and digitizers, 281

sampling, 281

Acquisition concepts, 281

Acquisition controls, 25

Acquisition menu

Clear, 115

Run/Stop, 115

Single/Seq, 115

acquisition menu, open, 71

acquisition mode, 115

acquisition modes, 283

act on trigger,

Active probes, 4, 285

Add

Bus waveform button, 37

Math waveform button, 37

Ref waveform button, 37

add a channel to the display, 73

add a measurement badge, 77

add a new bus, 135

add a search badge, 82

add function to math equation,

add measurement statistical readouts to badge, 44

add results table menu, 158

add statistic readouts to measurements, 129

add text to the screen, 314

add waveform to screen, 73

advanced math, 329

advanced math waveform, 229

advanced triggering, 97

AFG

sync out,

option, 37

Settings, 194

waveforms, saving, 197

AFG Out (rear panel), 35

aliasing

recognizing, 332

all files

saving, 112

amplifier mode, 278

Amplitude,

amplitude measurements

Amplitude,

Cycle Mean,

Cycle RMS,

High,

Low,

Max,

Mean,

Min,

Negative Overshoot,

Peak-To-Peak,

Positive Overshoot,

RMS,

Total Overshoot,

Amplitude Measurements panel,

analog channels, 189

annotating the screen, 314

annotations,

application bundle option, 10

arbitrary function generator, 43

Arbitrary function generator (SUP3-AFG), 8

arbitrary/function generator, 194

Area,

ARINC429,

Audio bus trigger settings,

audio serial bus menu,

auto serial bus menu,

auto-dim screen,

automated measurements, 319
automatic measurements, 315, 316
automatic peak markers,
automatic probe compensation (TPP250, TPP0500B,
TPP1000), 58

Autoset

button, 25

AUX Out

rear panel, 35

AUX trigger, 101

Average

acquisition mode, 115

avoid pinching when rotate handle, 18

B

B knob, 25

backlight,

badge types, 44

badges

spectrum view,

Bandwidth option upgrades, 14

Bandwidth options, 7

binary virtual keypad, 274

Blackman-Harris window

defined, 333

Burst Width,

Bus badge, 135

Bus button, 25

bus inputs, parallel,

bus menu, parallel,

bus search,

bus setup, 92

bus setup menus, 135

Bus trigger

defined, 308

bus waveforms, 75

C

cable lock, 35

calibration certificate, 3

CAN bus trigger settings,

CAN serial bus menu,

capturing screen shots,

center frequency, 200

change measurement settings, 79

change waveform settings, 84

channel badge, 44

channel badge menu, 189, 198

Channel buttons (front panel), 25

channel menu, 74

channel settings, 74

channel settings menu, 189, 198

Channel Settings menu

Other drawer,

channel vertical parameters menu, 74

Clear, 72

clear acquired waveform data, 115

Clear button, 25

Clipping, 285

clipping message, 44

common touchscreen UI tasks, 53

compensate passive probes, 60

compensate probes,

compensate TPP250, TPP0500B, TPP1000 probes, 58

Compensation and deskew accessory, 3

configuration menus, 50

configure a measurement, 79

configure cursors (RF view), 278

connect a monitor, 65

connect digital signals, 89

connect lock cable, 22

connect to a network, 61

connecting probes, 23

contact Tektronix, 2

Control windows

vertical acquisition, 286

copy files,

copyright,

correct handle rotate, 18

Coupling, 285

create folders,

Creating

create math waveforms, 324

Current probes, 4

Cursor measurements, 326

cursor readout (RF view), 278

cursor readouts, 319

cursor settings, 202
 cursors
 H Bar, 202
 V Bar, 202
 V&H Bar, 202
 Cursors button, 25
 Cursors button (touchscreen), 36
 cursors menu, 85
 cursors menu (RF view), 278
 customizing measurements, 107
 Cycle Area,
 Cycle Mean,
 Cycle RMS,

D

date, 203
 DC offset, 327
 decimal virtual logic keypad, 274
 declassification, 9
 Default setup, 86
 Default Setup button, 25
 define inputs (Setup and Hold trigger),
 Define Inputs menu (Logic search),
 define inputs, Logic trigger,
 define parallel bus inputs,
 Delay,
 delay trigger, 307
 delay triggering, 311
 delete a measurement badge, 81
 delete files,
 Demo,
 deskew channels,
 deskew probes, 63, 64
 Deskew pulse generator accessory, 3
 detection method, 278
 diagnostics,
 digital acquisition, 89
 digital channel configuration, 203
 digital channels option, 7
 digital voltmeter, 43, 204, 316
 display a channel, 73
 display cursors, 85
 display cursors (RF view), 278

display parameters, 103
 display settings,
 Displayed waveform, 285
 domain name,
 draw-a-box button, 105
 DVM, 204
 DVM option, 37
 dynamic range limit marker, 37

E

e* Scope HTTP Port,
 e*Scope, 88
 Edge search menu,
 Edge trigger menu,
 eject USB devices,
 electrostatic damage, preventing, 65
 elements
 math waveforms, 324
 email,
 enter password (Opt 3-SEC),
 enter security password (Opt 3-SEC),
 Envelope, 115
 envelope acquisition mode, 283
 Environment requirements, 19
 equation editor,
 erase memory,
 erase nonvolatile memory,
 errors,
 ESD, preventing, 65
 Ethernet bus trigger settings,
 Ethernet port (rear panel), 35
 Ethernet, connect to, 61
 excursion, 276
 expansion point, waveform, 37
 external
 triggering, 101
 external monitor, 65

F

factory calibration,
 factory settings, 86
 Fall Time,
 Falling Edge Count,

Fast Acq button, 25
Fast acquisitions, 86
FastAcq, 228
FastAcq acquisition mode, 283
FFT
 process, 331
 using, 330
FFT aliasing, 332
FFT math waveforms, 82
FFT window, 200
file menu, 205
file utilities menu,
firmware upgrade, 337
firmware, how to update, 56
FlexRay bus trigger settings,
FlexRay serial bus menu,
Force button, 25
Frequency,
frequency counter,
frequency domain cursors,
frequency domain display, 41
frequency domain measurements, 316
frequency domain menu,
Front cover, 3
front panel
 Acquisition, 25
 Autoset button, 25
 Bus button (front panel), 25
 Channel buttons (front panel), 25
 Clear button, 25
 Cursors button, 25
 Default Setup, 25
 description, 25
 Fast Acq button, 25
 Force button, 25
 High Res button, 25
 Horizontal, 25
 input connectors, 25
 Level knob, 25
 Math button (front panel), 25
 Mode button, 25
 multipurpose knobs, 25
 position

 knob (horizontal), 25
 Position knob, 25
 probe compensation connectors, 25
 Ref button (front panel), 25
 Run/Stop button, 25
 Scale knob, 25
 Scale knob (horizontal), 25
 Single/Seq button, 25
 Slope button, 25
 Touch Off button, 25
 Trigger, 25
 USB ports, 25
 Vertical, 25
functional test, 56

G

getting help, 2
GPIB address,
GPIB talk/listen address, 88
graticule intensity, 84, 104
graticule intensity, setting, 276
graticule style, 84, 104
graticule style, setting, 276

H

H Bar cursors, 202
Hamming window
 defined, 334
handle rotate, 18
handles, analog and digital, 37
Hanning window
 defined, 333
Hard transit case, 3
harmonics, 332
Harmonics,
HDMI output (rear panel), 35
help,
help menu, 205
Help system, 54
hex virtual keypad, 274
HF reject, 306
Hi Res

- acquisition mode, 115
 - High,
 - High Res acquisition mode, 283
 - High Res button, 25
 - holdoff, 305
 - holdoff, trigger, 99
 - Horizontal acquisition
 - delay, 287
 - position, 287, 314
 - reference point, 314
 - window, 285
 - Horizontal controls, 25
 - horizontal menu, open, 69
 - horizontal mode, 228
 - horizontal scale, 228
 - horizontal settings, 228
 - host name,
 - how to
 - add a measurement, 77
 - Add bus waveform, 75
 - Add math waveform, 75
 - Add reference waveform, 75
 - add waveform to screen, 73
 - change graticule intensity, 84
 - change graticule style, 84
 - change measurement settings, 79
 - change persistence, 84
 - change waveform intensity, 84
 - change waveform settings, 84
 - check power-on self tests results, 22
 - compensate TPP250, TPP0500B, TPP1000 probes, 58
 - connect probes, 23
 - connect to network, 61
 - connect to PC using USB cable, 88
 - Define Mask,
 - delete a measurement, 81
 - display cursors, 85
 - download, install firmware, 56
 - load a reference waveform, 113
 - open acquisition menu, 71
 - open horizontal menu, 69
 - quickly display waveform (Autoset), 68
 - recall a reference waveform, 113
 - recall an instrument setup, 114
 - remote access the oscilloscope (from Web), 88
 - run signal path compensation (SPC), 57
 - save a screen image, 110
 - save a waveform file, 111
 - save all, 112
 - save instrument settings, 112
 - set acquisition parameters, 71
 - set channel vertical parameters, 74
 - set date, 203
 - set GPIB talk/listen address, 88
 - set horizontal parameters, 69
 - set probe deskew, 74
 - set probe parameters, 74
 - set pulse width trigger, 98
 - set time, 55, 203
 - set trigger holdoff, 99
 - set trigger parameters, 69
 - set UTC time, 203
 - update firmware, 56
 - use Autoset, 68
 - use mouse with the UI, 53
- I**
- I/O,
 - I2C
 - bus trigger settings,
 - serial bus menu,
 - I2C bus trigger settings,
 - I2S,
 - inactive channel buttons, 37
 - ink saver mode,
 - Input
 - resistance, 285
 - termination, 285
 - Input channel
 - trigger sources, 303
 - Input connectors (front panel), 25
 - input signal level requirements, 20
 - install license,
 - install option license,
 - installed options,
 - installed probes,

- Instrument option upgrades, 13
- instrument settings
 - saving, 112
- instrument setup
 - recalling, 114
- intensity, 104
- intensity, graticule, 84
- intensity, waveform, 84
- IP address,
- IP address keypad, 275

K

- key features, xxi
- keyboard, 274
- keyboard, installing, 65
- keypad, 275
- knob A, 25
- knob B, 25

L

- LAN,
- LAN port (rear panel), 35
- LAN reset,
- LAN Reset,
- LAN status,
- LAN, connect to, 61
- Left Justified (LJ) audio bus,
- Level, 306
- Level knob, 25
- LF reject, 306
- license file (option), 15
- LIN bus trigger settings,
- LIN serial bus menu,
- load
 - waveform, 113
- loading
 - files,
 - reference waveforms,
 - setup files,
- lock to bench or rack, 22
- log files,
- log files, how to view,
- logic keypad, 274

- Logic search menu,
- Logic Search- Define Inputs menu,
- logic trigger, 309
- Logic trigger input settings,
- Low,
- LXI, 88

M

- MAC address,
- markers,
- markers (RF view),
- marking waveform events, 82
- math, 201, 329, 335
- Math button, 25
- math editor, 325
- Math equation, 324
- math syntax, 325
- math waveform,
- Math waveform
 - differentiation, 326
 - elements, 324
 - guidelines, 325
 - interactions, 324
 - offset, 327
 - position, 327
 - scale, 327
- math waveform menu, 229
- math waveforms
 - FFT, 82
- Max,
- Maximum signal level, 285
- Mean,
- measure
 - AC + DC RMS, 316
 - AC RMS, 316
 - DC, 316
 - frequency, 316
- Measure button, 36
- measurement
 - customizing, 107
 - reference levels, 107
- Measurement algorithms
 - Edge1, 322

- Edge2, 322
- Edge3, 322
- end, 322
- HighRef, 322
- LowRef, 322
- MidRef, 322
- min-max method, 321
- out of range samples, 323
- record length, 322
- start, 322
- top, base, 321
- variables, 321
- measurement annotations,
- measurement badge, 44
- measurement badge, delete, 81
- Measurement configuration menu, 129
- measurement gates
 - setting, 108
- Measurement Name panel,
- measurements
 - Amplitude,
 - Area,
 - Burst Width,
 - Cycle Area,
 - Cycle Mean,
 - Cycle RMS,
 - Delay,
 - Fall Time,
 - Falling Edge Count,
 - Frequency,
 - High,
 - Low,
 - Max,
 - Mean,
 - Min,
 - Negative Duty Cycle,
 - Negative Overshoot,
 - Negative Pulse Width,
 - Peak-To-Peak,
 - Period,
 - Phase,
 - Positive Duty Cycle,
 - Positive Overshoot,

- Positive Pulse Count,
- Positive Pulse Width,
- Rise Time,
- Rising Edge Count,
- RMS,
- Total Overshoot,
- menu
 - Reference waveform, 234
- Menu bar, 36
- menu panels, 50
- menus, 50
- MIL-STD-1553 bus trigger settings,
- Min,
- Mini keyboard, 3
- Mode button (front panel), 25
- modulation,
- monitor, connecting, 65
- mount drive, 61
- mount network drive menu,
- mouse, 3
- mouse touchscreen UI equivalents, 53
- mouse, installing, 65
- move cursors, 85
- multipurpose knobs, 25

N

- navigation buttons, badges, 44
- Negative Duty Cycle,
- Negative Overshoot,
- Negative Pulse Width,
- network address,
- network drive, 61
- network drive (standard instrument
 - unmount a network drive, 62
- network, connect to, 61
- noise reject, 306
- numeric keypad, 275
- nyquist, 331
- Nyquist point, 332

O

- octal virtual keypad, 274

- Offset
 - math offset and position, 327
- on screen keyboard, 274
- open acquisition menu, 71
- open horizontal menu, 69
- opening files,
- operating
 - altitude range, 19
 - humidity range, 19
 - temperature range, 19
- operating power requirements, 19
- option details,
- option license,
- options
 - install an option, 15
 - option license file, 15
- Options
 - 3-SEC (enhanced instrument security), 9
 - Power (Option 3-PWR, SUP3-PWR), 10
- Options, bandwidth, 7
- Options, upgrades, 13, 14
- Other drawer
 - Channel Settings menu,
- Other measurements
 - Area,
 - Cycle Area,
 - Falling Edge Count,
 - Positive Pulse Count,
 - Rising Edge Count,

P

- packing list, 3
- palette (Fast Acq), 86
- panels, menu, 50
- parallel bus
 - trigger, 101
- parallel bus inputs,
- parallel bus menu,
- parallel bus search,
- parallel bus trigger settings,
- parallel trigger menu,
- password, enter (Opt 3-SEC),
- password, set (Opt 3-SEC),
- paste files,

- Peak Detect
 - acquisition mode, 115
- peak detect acquisition mode, 283
- peak markers, 276
- Peak-To-Peak,
- Period,
- persistence, 103
- persistence, waveform, 84
- Phase,
- pick measurement,
- pinching and handle rotate, 18
- position
 - control, 285
 - knob, 25
 - knob (horizontal), 25
- Positive Duty Cycle,
- Positive Overshoot,
- Positive Pulse Count,
- Positive Pulse Width,
- power, 10
- power cord, 3
- power cord connector (rear panel), 35
- power cord options, 10
- power measurement, 133
- Power Measurement Name panel,
- power measurements, 319
- Power Measurements
 - Input analysis,
- Power Quality,
- power requirements, 19
- power standby mode, 21
- power-on self tests,
- power-on test results, 22
- powering on or off, 21
- preventing ESD, 65
- print,
- printer,
- probe
 - compensation,
 - compensation (TPP0500B, TPP1000), 58
 - compensation connectors, 25
 - compensation TPP250, 58
 - deskew, set, 74
 - errors,

- inputs, 25
- parameters, set, 74
- probe setup
 - analog,
- probes, connecting, 23
- product description, xxi
- projector, connecting, 65
- proper handle rotate, 18
- Pulse Width search menu,
- pulse width trigger, 98
- Pulse width trigger, 309

Q

- quantity, 276
- quick print,

R

- rack mount kit information, 24
- Rackmount kit accessory, 3
- RBW, 200
- readout, 276
- readouts, 319
- rear panel
 - AFG Out, 35
 - AUX Out, 35
 - cable lock, 35
 - connections, 35
 - Ethernet port (RJ-45), 35
 - HDMI output, 35
 - LAN port (RJ-45), 35
 - power cord, 35
 - security cable lock, 35
 - USB Device port, 35
 - USB Host ports, 35
- recall
 - instrument setup, 114
 - waveform, 113
- recall reference file menu, 235
- recalling, 109
- record length, 228
- Record length, 287
- Record length memory options, 8
- record view, waveform, 37

- Rectangular window
 - defined, 334
- Ref button, 25
- reference, 201
- reference level,
- reference levels
 - measurement, 107
- reference levels panel,
- Reference waveform menu, 234
- reference waveforms, 75, 288
- remote access (e*Scope), 88
- remote access (Web-based), 88
- remove AC power from instrument, 21
- rename files,
- requirements
 - altitude, 19
 - environment, 19
 - humidity, 19
 - power, 19
 - signal inputs, 20
 - temperature, 19
- resolution bandwidth, 200
- Results bar, 36
- results table, 158
- Results Table button, 36
- RF
 - badge, 278
 - channel, 198
 - measurements, 316
 - settings, 198, 276
- RF view
 - cursor display on-off, 278
 - cursors configuration menu, 278
 - M, A, N, m traces,
 - markers,
 - trace handle,
 - user interface,
- right click settings,
- Right Justified (RJ) audio bus,
- ripple,
- Rise Time,
- Rise/Fall Time search menu,
- rise/fall time trigger, 311
- Rising Edge Count,

- RM menu,
- RM3 rack mount, 24
- RMS,
- Rollmode acquisition mode, 283
- RS-232 serial bus menu,
- RS-232 serial bus search,
- RS-232 serial bus trigger,
- RS232 bus trigger settings,
- run signal path compensation, 57
- Run/Stop
 - Acquisition menu, 115
- Run/Stop button, 25
- Runt search menu,
- runt trigger, 309

S

- safe operating area,
- Sample
 - acquisition mode, 115
- sample acquisition mode, 283
- sample rate, 228
- Sampling process
 - defined, 281
- sanitize, 9
- save
 - all, 112
 - instrument settings, 112
 - screen image, 110
 - waveform file, 111
- Save As dialog, 197
- Save button, 25
- Save menu action, 197
- saving, 109
- saving ink on printed screen captures,
- scale buttons, badge, 44
- Scale controls
 - math, 327
 - positioning, 285
- Scale knob, 25
- Scale knob (horizontal), 25
- screen annotation, 276
- screen capture, 110
- screen captures, saving,
- screen dim,

- screen image
 - saving, 110
- screen keyboard, 274
- search, 159
- search badge, 44
- Search button, 36
- search menu
 - Edge,
 - Logic,
 - Pulse Width,
 - Rise/Fall Time,
 - Runt,
 - Setup and Hold,
 - Timeout,
- Search menu, 236
- search serial bus,
- search tables and zoom mode, 106
- searching for events, 82
- security,
- security cable lock, 35
- selected trace, 276
- self tests,
- SENT bus trigger settings,
- sequence trigger, 307
- Sequence trigger menu,
- sequential acquisition mode, 115
- sequential triggering, 100
- Sequential triggering, 311
- serial bus
 - RS-232,
 - trigger options, 9
 - triggering, 101
- serial bus configuration, 135
- serial bus search settings,
- serial bus trigger settings,
- serial bus, audio,
- serial bus, auto,
- serial bus, FlexRay,
- serial bus, I2C,
- serial bus, LIN,
- service name,
- service options, 11
- set
 - GPIO talk/listen address, 88

- probe
 - deskew, 74
 - probe parameters, 74
 - time, 55
- set measurement gates, 108
- set password (Opt 3-SEC),
- set security password (Opt 3-SEC),
- setting up a bus, 135
- Settings bar, 36
- settings, Edge trigger,
- settings, Video trigger,
- setup
 - parallel bus, 94
- Setup and Hold Search - Define Inputs menu,
- Setup and Hold search menu,
- Setup and hold trigger, 310
- show a measurement, 77
- signal input levels, 20
- signal path compensation,
- single acquisition mode, 115
- single sequence, 72
- Single Sequence/Stop After
 - Acquisition menu, 115
- Single/Seq
 - Acquisition menu, 115
- Single/Seq button, 25
- Slope
 - trigger, 306
- Slope button (front panel), 25
- span, 200
- Span:RBD,
- SPC,
- SPC (signal path compensation), 57
- spectral FastAcq setting, 228
- spectral math, 201
- spectral ref, 201
- spectrogram, 276, 278
- spectrogram display,
- spectrum math, 335
- spectrum traces, 278
- SPI bus trigger settings,
- SPI serial bus,
- SPMI bus trigger settings,
- standard accessories, 3, 17

- start frequency, 200
- stop acquisitions, 115
- stop frequency, 200
- subnet mask,
- SUP3-AFG option, 8
- Support, 2
- switching loss,
- syntax
 - math editor, 325
- system information,

T

- TDM audio bus,
- Technical support, 2
- TEK-DPG, 3
- TekSecure,
- Tektronix Technical Support, 2
- TekVPI input connectors, 25
- TekVPI probes, 4
- Termination, 285
- threshold, 276
- time, 203
- time domain measurements, 315
- time-domain vs frequency domain, 289
- time, how to set, 55
- Timebase Reference Source
 - Acquisition menu, 115
- Timeout search menu,
- timeout trigger,
- Timeout trigger, 309
- timing measurements
 - Burst Width,
 - Delay,
 - Fall Time,
 - Frequency,
 - Negative Duty Cycle,
 - Negative Pulse Width,
 - Period,
 - Phase,
 - Positive Duty Cycle,
 - Positive Pulse Width,
 - Rise Time,
- Total Overshoot,
- Touch Off button, 25

- touchscreen UI tasks, 53
- TPP0500B, 3
- TPP1000, 3
- trace markers,
- traces, 288
- traces panel,
- Transit case, hard plastic, 3
- trigger
 - act on trigger,
 - external signal, 101
 - holdoff,
 - level indicators, 37
 - logic,
 - mode,
 - parallel bus, 101
 - position indicator, 37
 - pulse width,
 - rise/fall time,
 - serial bus, 101
 - timeout,
- Trigger
 - considerations, 287
 - modes, 305
 - slope and level, 306
 - sources, 303
- Trigger controls, 25
- trigger coupling, 306
- trigger delay, 307
- trigger frequency,
- trigger holdoff, 99, 305
- trigger level, 306
- trigger menu, 69
- trigger menu, parallel,
- Trigger menus, 236
- trigger out,
- trigger position, 307
- trigger slope, 306
- trigger source, 303
- trigger the oscilloscope, 69
- trigger types, 304
- Triggering
 - modes, 305
 - sources, 303

- triggering concepts, 97, 303
- turn instrument on or off, 21

U

- unmount a network drive, 62
- unmount USB devices,
USB,
- USB bus trigger settings,
- USB cable, connect to PC, 88
- USB Device port (rear panel), 35
- USB Host ports (rear panel), 35
- USB ports (front panel), 25
- USB serial bus menu,
- use cursors, 85
- user button,
- user preferences
 - display settings,
- using
 - reference waveforms, 288
- using FFT, 330
- using mouse with the touchscreen, 53
- utility menu, 205

V

- V Bar cursors, 202
- V&H Bar cursors, 202
- variable persistence, 276
- Vertical acquisition, 286
- Vertical acquisition window, 285
- Vertical controls, 25
- Vertical offset, 286
- vertical settings, 189
- Video trigger menu,
- virtual keyboard, 274
- virtual keypad, 274, 275
- voltmeter, 43, 204, 316
- Volts per division
 - maximum, 285

W

- waveform

- expansion point, 37
- intensity, 84
- persistence, 84
- recalling, 113
- record view, 37
- XY, 81
- waveform badge, 44
- waveform cursors, 202
- Waveform differentiation, 326
- waveform dots style, setting, 276
- waveform editor, 325
- waveform file
 - saving, 111
- Waveform integration, 327
- waveform intensity, setting, 276
- waveform memory options, 8
- waveform persistence, 103
- waveform persistence, setting, 276
- waveform preview, 314
- waveform style, 103
- waveform style, setting, 276
- waveform vectors style, setting, 276
- Waveform View, 36

- Waveform View settings, 276
- Waveforms
 - math, 325
- waveforms, saving,
- welcome, xxi
- window, 200

X

- XY cursors, 320
- XY waveform, 81

Z

- zoom, 105
- Zoom, 228
- Zoom box, 51
- zoom icon, 37
- zoom mode, 105
- Zoom overview, 51
- Zoom title bar, 51
- zooming on search events, 106

